

General Safety Instructions:

READ SAFETY INSTRUCTIONS

Servicing:

These products are not customer serviceable TDK-Lambda UK LTD and their authorised agents only are permitted to carry out repairs.

Critical Components:

These products are not authorised for use as critical components in nuclear control systems, life support systems or equipment for use in hazardous environments without the express written approval of the Managing Director of TDK-Lambda EMEA.

Product Usage:

These products are designed for use within a host equipment which restricts access to authorised competent personnel.

This product is a component power supply and is only to be installed by qualified persons within other equipment and must be not operated as a stand alone product.

This product is for sale to business to business customers and can be obtained via distribution channels. It is not intended for sale to end users.

This product is a component power supply and does not fall within the scope of the EMC directive. Compliance with the EMC directive must be considered in the final installation. Please contact your local TDK-Lambda office.

Environmental:

These products are IPX0, and therefore chemicals/solvents, cleaning agents and other liquids must not be used.

Environment:

This power supply is a switch mode power supply for use in applications within a Pollution Degree 2, overvoltage category II environment. Material Group IIIb PCB's are used within it.

Output Loading:

The output power taken from the power supply must not exceed the rating stated on the power supply label, except as stated in the product limitations in this handbook.

Input Parameters:

This product must be operated within the input parameters stated in the product limitations in this handbook.

End of Life Disposal:

The unit contains components that require special disposal. Make sure that the unit is properly disposed of at the end of its service life and in accordance with local regulations.



RISK OF ELECTRIC SHOCK

High Voltage Warning:

Dangerous voltages are present within the power supply. The professional installer must protect service personnel from inadvertent contact with these dangerous voltages in the end equipment.

WARNING: When installed in a Class 1 end equipment, this product must be reliably earthed and professionally installed.

The (+) or (-) output(s) can be earthed or left floating.

The unit cover(s)/chassis (where applicable) must not be made user accessible.

The mains input connector is not acceptable for use as field wiring terminals.

For encased products, do not use mounting screws, which penetrate the unit more than; See drawings.

Internal fuses protect the unit and must not be replaced by the user. In case of internal defect, the unit must be returned to TDK-Lambda UK LTD or one of their authorised agents.

A suitable mechanical, electrical and fire enclosure must be provided by the end use equipment for mechanical, electric shock and fire hazard protection.

Energy Hazards:

The main output of this product is capable of providing hazardous energy (240VA). Final equipment manufacturers must provide protection to service personnel against inadvertent contact with the output terminals.

The unit cover/chassis, where applicable, is designed to protect skilled personnel from hazards. They must not be used as part of the external covers of any equipment where they may be accessible to operators, since under full load conditions, part or parts of the unit chassis may reach temperatures in excess of those considered safe for operator access.

Allgemeine Sicherheitsvorschriften:

LESEN SIE DIE SICHERHEITSVORSCHRIFTEN

Wartung:

Diese Produkte können nicht durch den Kunden gewartet werden. Nur TDK-Lambda UK LTD. und deren zugelassene Vertriebshändler sind zur Durchführung von Reparaturen berechtigt.

Kritische Komponenten:

Diese Produkte sind nicht für die Verwendung als kritische Komponenten in nuklearen Kontrollsystemen, Lebenserhaltungssystemen oder Geräten in gefährlichen Umgebungen geeignet, sofern dies nicht ausdrücklich und in Schriftform durch den Geschäftsführer von TDK-Lambda EMEA genehmigt wurde.

Produktverwendung:

Diese Produkte sind zur Verwendung innerhalb von Host-Anlagen gedacht, die einen auf das Fachpersonal beschränkten Zugang haben.

Dieses Produkt ist eine Stromversorgungs-Komponente und sie darf nur von qualifiziertem Personal in andere Geräte eingebaut werden und sie darf NICHT als eigenständiges ("Stand-Alone") Gerät betrieben werden.

Dieses Produkt ist für den Verkauf an Geschäftskunden entwickelt worden und es kann über Distributionskanäle bezogen werden.

Es ist NICHT für den Verkauf an Endkunden gedacht und konzipiert.

Dieses Produkt ist eine Stromversorgungsbaugruppe und sie fällt NICHT in den Bereich der EMV Direktive.

Die Konformität mit der EMV Richtlinie muss in der finalen Gesamtinstallation betrachtet werden.

Bitte kontaktieren Sie Ihr regionales TDK-Lambda Vertriebsbüro im Falle von Rückfragen.

Umwelt:

Diese Produkte sind IPX0, aus diesem Grund dürfen keine Chemikalien/Lösungsmittel, Reinigungsmittel und andere Flüssigkeiten verwendet werden.

Umgebung:

Dieses Netzteil ist ein Schaltnetzteil zur Verwendung in einer Umgebung mit einem Verschmutzungsgrad 2, Überspannungskategorie II. Materialgruppe IIIb mit darin verwendeten PCBs.

Ausgangsstrom:

Der Ausgangsstrom des Netzteiles darf die Leistung, die auf dem Label des Netzteiles vermerkt ist, nur dann überschreiten, wenn dies in den Produktgrenzen dieses Handbuches ausgezeichnet ist.

Eingangsparameter:

Dieses Produkt muss innerhalb der Eingangsparameter, die in den Produktgrenzen dieses Handbuches angegeben sind, betrieben werden.

Entsorgung am Ende der Betriebszeit:

Das Gerät enthält Komponenten die unter Sondermüll fallen. Das Gerät muss am Ende der Betriebszeit ordnungsgemäß und in Übereinstimmung mit den regionalen Bestimmungen entsorgt werden.

**GEFAHR DURCH ELEKTRISCHEN SCHLAG****Hochspannungswarnung:**

Innerhalb des Netzteiles gibt es gefährliche Spannungen. Der Elektroinstallateur muss das Wartungspersonal vor versehentlichem Kontakt mit den gefährlichen Spannungen im Endgerät schützen.

WARNUNG! Falls Sie unser Netzgerät in eine Anwendung mit Schutzklasse 1 eingebaut haben, stellen Sie sicher, dass es fachgerecht installiert und zuverlässig geerdet ist.

Die (+) oder (-) Ausgänge können geerdet werden oder unangeschlossen bleiben.

Die Abdeckung des Gerätes/das Gehäuse darf für den Benutzer nicht zugänglich sein.

Der Haupteingangsanschluss ist nicht für die Verwendung als Feldverdrahtungsanschluss geeignet.

Für ummantelt Produkte, verwenden Sie keine Schrauben, die das Gerät mehr als durchdringen; siehe Zeichnung. Eine interne Sicherung schützt das Gerät und darf durch den Benutzer nicht ausgetauscht werden. Im Fall von internen Defekten muss das Gerät an TDK-Lambda UK LTD oder einen der autorisierten Vertriebs Händler zurückgeschickt werden.

Ein geeignetes mechanisches, elektrisches und brandgeschütztes Gehäuse muss als Schutz vor der Gefahr von mechanischen Risiken, Stromschlägen und Brandschutz in dem Endgerät vorgesehen werden.

Gefahren durch elektrische Energie:

Von bestimmten Modulen kann je nach Einstellung der Ausgangsspannung gefährliche elektrische Energie ausgehen (240 VA). Die Endgerätehersteller müssen einen Schutz für Servicepersonal vor unbeabsichtigtem Kontakt mit den Ausgangsanschlüssen dieser Module vorsehen. Kann aufgrund der Einstellung gefährliche elektrische Energie auftreten, dürfen die Modulanschlüsse für den Benutzer nicht zugänglich sein.

Die Geräteabdeckung/das Gehäuse ist so entworfen, dass das Fachpersonal vor Gefahren geschützt wird. Sie dürfen nicht als Teil der externen Abdeckung für Geräte verwendet werden, die für den Betreiber zugänglich sein müssen, da Teile oder das gesamte Gerätegehäuse unter voller Auslastung übermäßige Temperaturen erreichen kann, die für den Zugang des Betreibers nicht mehr als sicher betrachtet werden.

Consignes générales de sécurité:

LIRE LES CONSIGNES DE SECURITE

Entretien:

Ces produits ne peuvent pas être réparés par l'utilisateur. Seuls, TDK-Lambda UK LTD et ses agents agréés sont autorisés à effectuer des réparations.

Composants critiques:

Ces produits ne doivent pas être utilisés en tant que composants critiques dans des systèmes de commande nucléaire, dans des systèmes de sauvetage ou dans des équipements utilisés dans des environnements dangereux, sans l'autorisation écrite expresse du directeur général de TDK-Lambda EMEA.

Utilisation du produit:

Ces produits sont conçus pour être utilisés dans un équipement hôte dont l'accès n'est autorisé qu'aux personnes compétentes.

Ce produit est une alimentation considérée comme un composant devant être installé par des personnes qualifiées, dans un autre équipement. Il ne doit pas être utilisé en tant que produit fini.

Ce produit est destiné à la vente entre entreprises et peut être obtenu via des canaux de distribution.

Il n'est pas prévu à la vente pour les particuliers.

Ce produit est une alimentation considérée comme un composant, il ne relève pas du champ d'application de la directive CEM. Le respect de la directive CEM doit être pris en compte dans l'installation finale. Veuillez contacter votre bureau TDK-Lambda le plus proche.

Environnement:

Ces produits sont IPX0, et donc on ne doit pas utiliser des produits chimiques/solvants, des produits de nettoyage et d'autres liquides.

Environnement fonctionnel :

Cette alimentation fonctionne en mode commutation pour utilisation dans des applications fonctionnant dans un environnement avec Degré de Pollution 2 et catégorie de surtension II. Elle utilise des cartes des circuits imprimés (PCB) de Groupe IIIb.

Intensité soutirée:

L'intensité soutirée de l'alimentation ne doit pas dépasser l'intensité nominale marquée sur la plaque signalétique, sauf indications contraires dans les limitations du produit décrit dans ce manuel.

Paramètres d'entrée:

Ce produit doit être utilisé à l'intérieur des paramètres d'entrée indiqués dans les limitations du produit dans ce manuel.

Elimination en fin de vie:

L'alimentation contient des composants nécessitant des dispositions spéciales pour leur élimination. Vérifiez que cette alimentation est mise au rebut correctement en fin de vie utile et conformément aux réglementations locales en vigueur.



RISQUE DE CHOC ELECTRIQUE

Attention-Danger haute tension:

Des tensions dangereuses sont présentes dans l'alimentation. L'installateur doit protéger le personnel d'entretien contre un contact involontaire avec ces tensions dangereuses dans l'équipement final.

AVERTISSEMENT: Si ce produit est installé dans un équipement final de classe I, il doit être mis à la terre de manière fiable et installé par un professionnel averti.

Les sorties (+) ou (-) peuvent être raccordées à la terre ou laissées flottantes.

Le couvercle/châssis de l'alimentation ne doit pas être accessible à l'utilisateur. Le connecteur d'entrée d'alimentation principale ne doit pas être utilisé comme borne de raccordement.

N'utilisez pas de vis pénétrant dans le module sur une profondeur supérieure à : Voir dessins.

Un fusible interne protège le module et ne doit pas être remplacé par l'utilisateur. En cas de défaut interne, le module doit être renvoyé à TDK-Lambda UK LTD ou l'un de ses agents agréés.

Une enceinte appropriée doit être prévue par l'utilisateur final pour assurer la protection contre les chocs mécaniques, les chocs électriques et l'incendie.

Energies dangereuses :

Certains modules peuvent générer une énergie dangereuse (240 VA) selon le réglage de tension de sortie. Le fabricant de l'équipement final doit assurer la protection des techniciens d'entretien contre un contact involontaire avec les bornes de sortie de ces modules. Si une telle tension dangereuse risque de se produire, les bornes ou les connexions du module ne doivent pas être accessibles par l'utilisateur.

Le couvercle et le châssis du module sont conçus pour protéger des personnels expérimentés. Ils ne doivent pas être utilisés comme couvercles extérieurs d'un équipement, accessible aux opérateurs car en condition de puissance maximum, des parties du châssis peuvent atteindre des températures considérées comme dangereuses pour l'opérateur.

Norme generali di sicurezza:

SI PREGA DI LEGGERE LE NORME DI SICUREZZA

Manutenzione:

Il cliente non può eseguire alcuna manutenzione su questi prodotti. L'esecuzione delle eventuali riparazioni è consentita solo a TDK-Lambda UK LTD e ai suoi agenti autorizzati.

Componenti critici:

Non si autorizza l'uso di questi prodotti come componenti critici all'interno di sistemi di controllo nucleari, sistemi necessari alla sopravvivenza o apparecchiature destinate all'impiego in ambienti pericolosi, senza l'esplicita approvazione scritta dell'Amministratore Delegato di TDK-Lambda EMEA.

Uso dei prodotti:

Questi prodotti sono progettati per l'uso all'interno di un'apparecchiatura ospite che limiti l'accesso al solo personale competente e autorizzato.

Questo prodotto è da considerarsi come un alimentatore professionale componente e come tale deve essere installato da personale qualificato all'interno di altre apparecchiature e non può essere utilizzato come prodotto indipendente.

Questo prodotto non è inteso per la vendita al dettaglio o agli utilizzatori finali.

Questo alimentatore è da considerarsi come un componente e come tale non è assoggettato dagli scopi della direttiva EMC. Conformità alla direttiva EMC deve essere considerata nell'installazione finale di utilizzo. Gli uffici di TDK-Lambda Sas Succursale Italiana sono a vostra disposizione per ulteriori raggugli.

Condizioni ambientali:

Questi prodotti sono classificati come IPX0, dunque non devono essere utilizzati sostanze chimiche/solventi, prodotti per la pulizia o liquidi di altra natura.

Ambiente:

Questo prodotto è un alimentatore a commutazione, destinato all'uso in applicazioni rientranti in ambienti con le seguenti caratteristiche: Livello inquinamento 2, Categoria sovratensione II. Questo prodotto contiene schede di circuiti stampati in materiali di Gruppo IIIb.

Carico in uscita:

La potenza in uscita ottenuta dall'alimentatore non deve superare la potenza nominale indicata sulla targhetta dell'alimentatore, fatto salvo dove indicato nei limiti per il prodotto specificati in questo manuale.

Parametri di alimentazione:

Questo prodotto deve essere utilizzato entro i parametri di alimentazione indicati nei limiti per il prodotto, specificati in questo manuale.

Smaltimento:

L'unità contiene componenti che richiedono procedure speciali di smaltimento. Accertarsi che l'unità venga smaltita in modo corretto al termine della vita utile e nel rispetto delle normative locali.



RISCHIO DI SCOSSA ELETTRICA

Avvertimento di alta tensione:

All'interno dell'alimentatore sono presenti tensioni pericolose. Gli installatori professionali devono proteggere il personale di manutenzione dal rischio di contatto accidentale con queste tensioni pericolose all'interno dell'apparecchiatura finale.

ATTENZIONE: Se installato in un'attrezzatura di classe I, questo prodotto deve essere collegato a terra in modo affidabile ed installato in modo professionale.

Le uscite (+) o (-) possono essere messa a terra o lasciate isolate.

I coperchi/il telaio dell'unità non devono essere accessibili da parte dell'utente.

Il connettore dell'alimentazione principale non può essere utilizzato come terminale di collegamento di campo.

Non utilizzare viti che penetrano nell'unità per più di : Vedi disegni

Un fusibile interno protegge l'unità e non deve essere sostituito dall'utente. Nell'eventualità di un difetto interno, restituire l'unità a TDK-Lambda UK LTD o a uno dei suoi agenti autorizzati.

L'apparecchiatura finale deve includere una recinzione meccanica, elettrica e antincendio per proteggere dai pericoli di natura meccanica, dalle scosse elettriche e dai pericoli di incendio.

Pericoli energetici:

Alcuni moduli sono in grado di erogare energia pericolosa (240 VA) a seconda della tensione in uscita impostata. I produttori delle apparecchiature finali sono tenuti a proteggere il personale di manutenzione dal rischio di contatto accidentale con questi terminali dei moduli di uscita. Se impostati su livelli che non escludono l'erogazione di energia pericolosa, questi terminali o collegamenti non devono risultare accessibili da parte dell'utente.

Il coperchio/telaio dell'unità è realizzato per proteggere il personale esperto dai pericoli. Non deve essere usato come parte degli involucri esterni di qualsiasi apparecchiatura, se risulta accessibile da parte degli addetti, poiché è possibile che in condizioni di pieno carico una o più parti del telaio dell'unità giunga/ giungano a temperature superiori ai limiti considerati sicuri per l'accesso da parte degli addetti.

Instrucciones generales de seguridad:

LEA LAS INSTRUCCIONES DE SEGURIDAD

Servicio:

Estos productos no pueden ser reparados por los clientes. TDK-Lambda UK LTD. y sus agentes autorizados son los únicos que pueden llevar a cabo las reparaciones.

Componentes fundamentales:

Estos productos no pueden ser utilizados como componentes fundamentales en sistemas de control nuclear, sistemas de soporte vital o equipos a utilizar en entornos peligrosos sin el consentimiento expreso por escrito del Director General de TDK-Lambda EMEA.

Uso de los productos:

Estos productos han sido diseñados para ser utilizados en un equipo central que restrinja el acceso al personal cualificado autorizado.

Este producto es una fuente de alimentación y sólo puede ser instalado por personal cualificado dentro de otros equipos y no debe ser tratado como un producto independiente. Este producto debe ser vendido entre empresas profesionales y solo puede obtenerse a través de los canales de distribución. No está destinado para la venta a usuarios finales.

Este producto es una fuente de alimentación y no se ve afectada por la directiva EMC. El cumplimiento de la directiva EMC se debe considerar en la instalación final. Por favor, póngase en contacto con su oficina local de TDK - Lambda.

Medioambiental:

Estos productos son IPX0 y, por tanto, no pueden utilizarse sustancias químicas/disolventes, agentes de limpieza ni otros líquidos.

Medio ambiente:

Esta fuente de alimentación es una fuente de alimentación de modo conmutado a utilizar en aplicaciones dentro de un entorno con un Grado de contaminación 2 y una Categoría de sobretensión II. En él se utilizan policloruros de bifenilo del Grupo de materiales IIIb.

Carga de salida:

La potencia de salida tomada de la fuente de alimentación no puede sobrepasar el valor nominal indicado en la etiqueta de la fuente de alimentación, excepto en los casos indicados en las limitaciones del producto en este manual.

Parámetros de entrada:

Este producto debe ser utilizado dentro de los parámetros de entrada indicados en las limitaciones del producto en este manual.

Desecho de la unidad:

La unidad contiene componentes que deben ser desechados de una manera especial. Asegúrese de desechar correctamente la unidad al final de su vida útil y conforme a las normas locales vigentes.



PELIGRO DE DESCARGAS ELÉCTRICAS

Advertencia de alta tensión:

En esta fuente de alimentación hay tensiones peligrosas. El instalador profesional debe proteger al personal de servicio contra cualquier contacto accidental con estas tensiones peligrosas en el equipo final.

ADVERTENCIA: La instalación de este producto en un equipo de clase I la deben llevar a cabo profesionales y el producto debe estar conectado a tierra.

La salida o salidas (+) o (-) pueden conectarse a tierra o se las puede dejar flotando.

Debe impedirse el acceso de los usuarios a la cubierta o cubiertas y al chasis de la unidad.

El conector de entrada de la red no es apto para ser utilizado a modo de bornes de cableado de campo.

No utilice tornillos de montaje susceptibles de penetrar en la unidad más de: Ver dibujos.

Un fusible interno protege la unidad y este no debe ser nunca reemplazado por el usuario. En caso de existir algún defecto interno, la unidad debe ser enviada a TDK-Lambda UK LTD o a uno de sus agentes autorizados.

El equipo de uso final debe constituir un recinto de protección mecánica, eléctrica y contra incendios de protección mecánica, contra descargas eléctricas y contra el peligro de incendios.

Peligros de energía:

Algunos módulos pueden generar energía peligrosa (240VA) dependiendo de la configuración de la tensión de salida. Los fabricantes de equipos finales deben proteger al personal de servicio contra un contacto accidental con estos bornes de salida de los módulos. Si se configura de modo que pueda generarse energía peligrosa, hay que evitar que el usuario pueda acceder a los bornes o conexiones del módulo.

La cubierta/chasis de la unidad ha sido diseñada para que proteja a las personas cualificadas de los peligros. No deben ser utilizadas como parte de las cubiertas externas de cualquier equipo al que pueden acceder los operarios, ya que bajo unas condiciones de carga completa, la pieza o piezas del chasis de la unidad pueden alcanzar temperaturas superiores a las consideradas seguras para el acceso de los operarios.

Instruções gerais de segurança:

LEIA AS INSTRUÇÕES DE SEGURANÇA

Manutenção:

Estes produtos não são podem ser submetidos a manutenção por parte do cliente. Apenas a TDK-Lambda UK LTD e os seus agentes autorizados têm permissão para realizar reparações.

Componentes essenciais:

Não é autorizada a utilização destes produtos como componentes essenciais de sistemas de controlo nuclear, sistemas de suporte de vida ou equipamento para utilização em ambientes perigosos sem a expressa autorização por escrito do Director-Geral da TDK-Lambda EMEA.

Utilização do produto:

Estes produtos foram concebidos para utilização dentro de um equipamento de alojamento que apenas permita o acesso a pessoal qualificado autorizado.

Este produto é uma alimentação considerado com um componente para ser instalado por pessoas qualificadas, em outros equipamentos. Não deve ser usado como um produto acabado.

Este produto é destinado para venda entre as empresas e pode ser obtido através de canais de distribuição. Não se destina à venda aos particulares.

Este produto é uma alimentação considerado com um componente, não é dentro do application âmbito da directiva CEM.

Conformidade com a directiva CEM devem ser considerados na instalação final.

Entre em contacto com seu escritório TDK-Lambda mais próximo.

Ambiental:

Estes produtos são IPX0 e, como tal, não se devem utilizar químicos/solventes, agentes de limpeza e outros líquidos.

Ambiente:

Esta fonte de alimentação é uma fonte de alimentação do modo de comutação para utilização em aplicações com um Nível de Poluição 2 e ambientes da categoria de sobretensão II. São utilizadas placas de circuitos impressos do grupo de materiais IIIb.

Carga de saída:

A potência de saída extraída da fonte de alimentação não deve exceder a classificação assinalada na etiqueta da fonte de alimentação, excepto quando indicado nas limitações do produto neste guia.

Parâmetros de entrada:

Este produto deve ser utilizado dentro dos parâmetros de entrada indicados nas limitações do produto neste guia.

Eliminação no fim de vida:

A unidade contém componentes que necessitam de procedimentos especiais de eliminação. Certifique-se de que a unidade é devidamente eliminada no fim da sua vida útil e que tal é feito em conformidade com os regulamentos locais.



RISCO DE CHOQUE ELÉCTRICO

Aviso de alta tensão:

Estão presentes tensões perigosas dentro da fonte de alimentação. O profissional que realizar a instalação deve proteger o pessoal de assistência contra contactos inadvertidos com estas tensões perigosas do equipamento final.

AVISO: Quando instalado num equipamento de Classe I, este produto deve ser ligado à terra de forma fiável e instalado por um profissional.

As saídas (+) e (-) podem ser ligadas à terra ou deixadas soltas.

O chassis/cobertura(s) da unidade não deve estar acessível ao utilizador.

O conector de entrada de alimentação não deve ser utilizado como terminal de cablagens no local.

Não utilize parafusos de montagem, uma vez que estes penetrarão na unidade em mais do que: Veja os desenhos

Existe um fusível interno que protege a unidade e que não deve ser substituído pelo utilizador. Em caso de defeito interno, a unidade deve ser devolvida à TDK-Lambda UK LTD ou a um dos seus agentes autorizados.

O equipamento de utilização final deve fornecer um bastidor com protecção mecânica, eléctrica e contra incêndios adequada.

Perigos de energia:

Alguns módulos tem a capacidade de fornecer energia perigosa (240 VA), de acordo com a configuração da tensão de saída. O equipamento final do fabricante deve garantir que o pessoal de assistência está protegido contra contactos inadvertidos com estes terminais de saída do módulo. Se essa energia perigosa for produzida, as ligações e os terminais do módulo não devem ser acessíveis pelos utilizadores.

O chassis/cobertura da unidade está concebido de forma a proteger o pessoal especializado de perigos. Não devem ser utilizados como parte das coberturas externas de qualquer equipamento em que possam estar acessíveis aos operadores, uma vez que em condições de carga máxima, algumas peças do chassis da unidade podem atingir temperaturas superiores às consideradas seguras para o acesso do operador.

TDK-Lambda

TDK-Lambda UK Ltd
Kingsley Avenue, Ilfracombe
Devon, EX34 8ES
Telephone - Sales and Service +44 (0)1271 856666
Head Office and Works +44 (0)1271 856600
Facsimile +44 (0)1271 864894
WEBSITE: www.uk.tdk-lambda.com

RFE1600 Series Instruction Manual

RFE1600 SERIES SPECIFICATIONS:			RFE1600-12	RFE1600-24	RFE1600-32	RFE1600-48	
1	Rated output voltage	V	12	24	32	48	
2	Output voltage set point	V	12±1%	24±1%	32±1%	48±1%	
3	Output voltage range	V	9.6~13.2	19.2~29.0	25.6~38.4	38.4~58	
4	Rated Output Current at Vin ≥ 170Vac (*1)	A	133	67	47	33	
5	Rated Output Current at 100 ≤ Vin ≤ 132Vac (*1)	A	92	46	34.5	23	
6	Rated Output Current at 85V ≤ Vin < 100Vac (*1)	A	Linear derating 1% per 1VAC from output current at 100VAC:				
7	Rated output power Vin ≥ 170Vac	W	1596	1608	1500	1584	
8	Rated output power 100 ≤ Vin ≤ 132Vac	W	1104	1104	1104	1104	
9	Rated output power 85Vac ≤ Vin < 100Vac	W	Linear derating 1% per V				
10	Input voltage / frequency range (*2)	---	85~265Vac continuous, 47~63Hz, Single phase				
11	Maximum input current (115/230Vac)	A	11.6/8.1				
12	Power Factor (Typ) (100/230Vac) at full load	---	>0.99/0.98				
13	Efficiency at 75% rated load (Typ) (*3)	%	87/90%	88/90%	88/90%	89/92%	
14	Efficiency at 100% rated load (Typ) (*3)	%	87/90%	87/90%	87/90%	88/91%	
15	Inrush current (*4)	A	Less than 35A				
16	Hold-up time	mS	≥ 10mS typical at 115/230Vac input, rated output voltage and less than 80% of rated load.				
17	Maximum line regulation (*5)	%	0.25%				
18	Max load regulation (*6)	%	0.50%				
19	Output Ripple and noise P-P (*7)	0~+70°C	mV	240	240	320	480
		-10~0°C	mV	360	360	580	780
20	Temperature stability	%	0.05% of rated Vout for 8hrs after 30min warm-up. Constant line, load and temperature.				
21	Temperature coefficient of output voltage	PPM/°C	±200				
22	Remote sensing (*8)	---	Refer to instruction manual.				
23	Parallel operation (*9)	---	Single wire current share, 5% accuracy of rated lout, up to 10 units.				
24	Series operation	---	(with external diodes), 2 units. Refer to instruction manual.				
25	Over current protection	85 ≤ Vin ≤ 132Vac	%				
		170 ≤ Vin ≤ 265Vac	%				
26	Over voltage protection (*10)	V	Tracking OVP, range: 1.1xVout ,Accuracy:±3%, Refer to Instruction Manual.				
27	Over temperature protection	---	Inverter shut down, automatic restart.				
28	Remote On/Off control	---	Two complementary inputs. By electrical signal or dry contact. Refer to instruction manual.				
29	"DC OK" signal (*13)	---	Tracking, On when Vout>90±5% of set output voltage. Open collector signal. Max sink current: 10 mA.				
30	Over-Temperature warning (*13)	---	Refer to instruction manual. Open collector signal. Max sink current: 10 mA.				
31	"AC FAIL" signal (*13)	---	On when 85Vac<Vin<270Vac. Open collector signal. Max sink current: 10 mA.				
32	Auxiliary power supply output (*11)	---	11.2~12.5V, 0.5A. 240mVp-p ripple and noise				
33	Vout programming by external voltage	---	By 0~5V, equal to Vout min ~ Vout max . Refer to Instruction Manual.				
34	Vout programming by built-in potentiometer	---	By 1Kohm potentiometer . Refer to Instruction Manual.				
35	OCP programming by external voltage	---	By 0~5V, Refer to Instruction Manual.				
36	Rear panel indicators	---	DC OK				
37	I ² C Interface	---	Optional, PMBus compatible. Refer to Instruction Manual.				
38	Operating temperature (*14)	---	-10~+50°C. 100% load. +50°C to +60°C Derate Output by 2%/°C. +60°C to +70°C Derate Output by 2.5%/°C.				
39	Storage temperature	---	-30~85°C				
40	Operating humidity	---	10~90% RH, no condensation.				
41	Storage humidity	---	10~95% RH, no condensation.				
42	Cooling	---	By internal Fans. Variable speed control based on ambient temperature and power level.				
43	Vibration	---	At no operation, 10 – 50Hz (sweep for 1min) 2G Const. X,Y,Z 1h each				
44	Shock	---	Less than 20G				
45	Conducted emission	---	Built to meet EN55022 Class B, FCC part 15 Class-B, VCCI Class-B				
46	Radiated emission	---	Built to meet EN55022 Class A, FCC part 15 Class-A, VCCI Class-A				
47	Immunity	---	Built to meet IEC61000-4-2 (Level 2,3), -3 (Level 2), -4 (Level 2), -5 (Level 3,4), -6 (Level 2), -8 (Level 4), -11				
48	Applicable safety standards		---	Built to meet UL60950-1 Second Edition, EN60950-1 Second Edition			
	Withstand voltage	Input-Output:	---	3000Vrms, 1min.			
		Input-Ground:	---	2000Vrms, 1min.			
49		Output - Ground:	---	500VAC 1min.	500VAC 1min.	500VAC 1min.	2250VDC 1min (POE)
50	Insulation resistance	---	More than 100MΩ at 25°C and 70% RH. Output-Ground: 500Vdc				
51	Leakage current (*12)	mA	Less Than 0.75/1.5mA at 115/230Vac range				
52	Weight (Typ)	Kg	Max. 1.7				
53	Size (W*H*D)	---	85x41x320mm. Refer to Outline Drawing.				

Notes:

- *1 Refer to Fig-1 below.
- *2 In case where conformance to various safety standards is required, to be described as 100-240Vac (50/60Hz).
- *3 115/230Vac, 25°C ambient temperature.
- *4 Not applicable for the noise filter inrush current less than 0.2mS.
- *5 From 85~132Vac, or 170~265Vac, constant load.
- *6 From No-load to Rated load, constant input voltage.
- *7 Measured with JEITA-RC9131A 1:1 probe with 2x270μF electrolytic capacitors and 1μF film capacitor on the output. 20MHz B.W.
- *8 Voltage drop on load wires: RFE1600-12: 0.25V/wire, RFE1600-24: 0.5V/wire, RFE1600-32: 0.75V/wire and RFE1600-48: 1V/wire.
- *9 Accuracy applicable for load current > 50% of rated output current. Derate maximum output power by 5%.
- *10 Inverter shut down method. Reset by recycle AC voltage, or by On/Off control.
- *11 Measured with JEITA-RC9131A 1:1 probe using 470μF electrolytic capacitor and 0.1μF film capacitor on the output. 20MHz B.W.
- *12 Measured according to UL/EN method at 60Hz 25°C ambient temperature.
- *13 Open collector signal. Maximum sink current: 10mA, maximum voltage 15V.
- *14 Refer to Output Power vs temp derating figure 2(A,B,C). (Pg. 3)

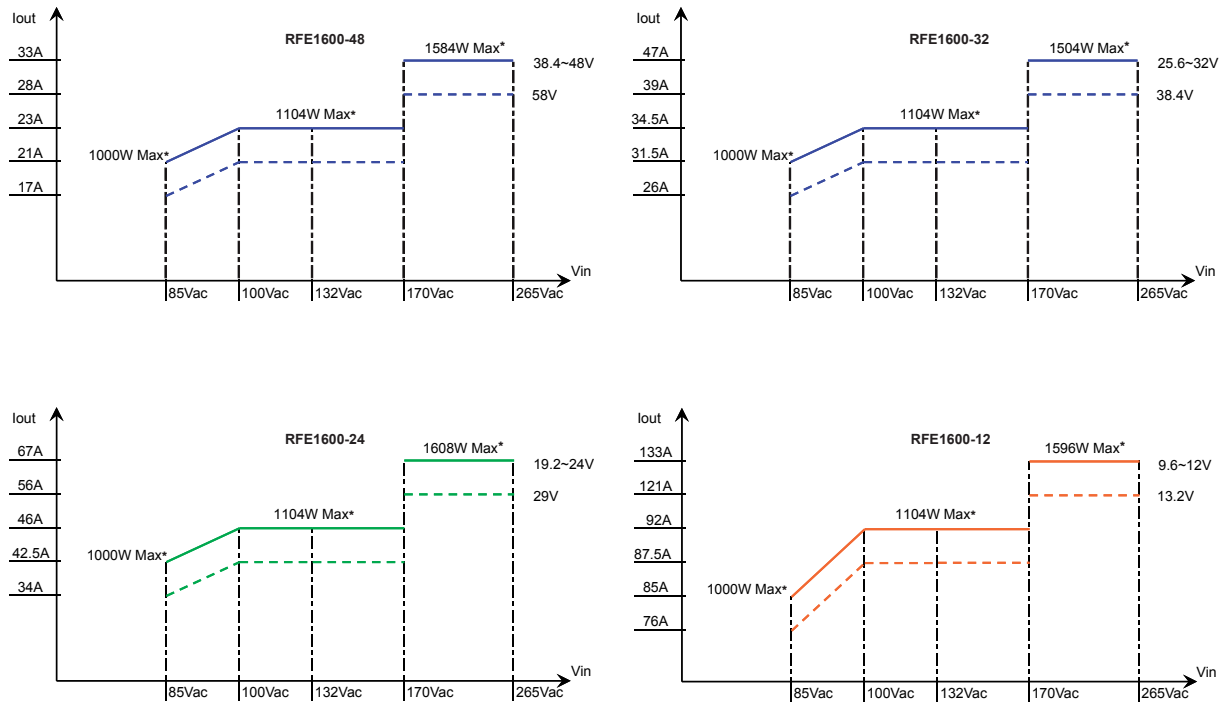
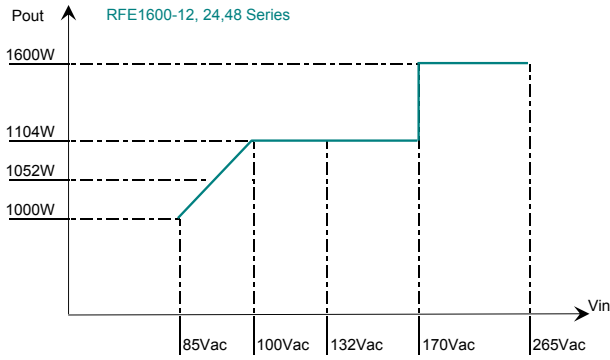

Fig-1 RFE1600 rated output Current and Voltage versus Line Voltage.

* Please refer to Output Power vs. Temp derating

Output Power vs. Temp derating



All Output Voltages
Fig A. Output Power at temp -10~50°C.

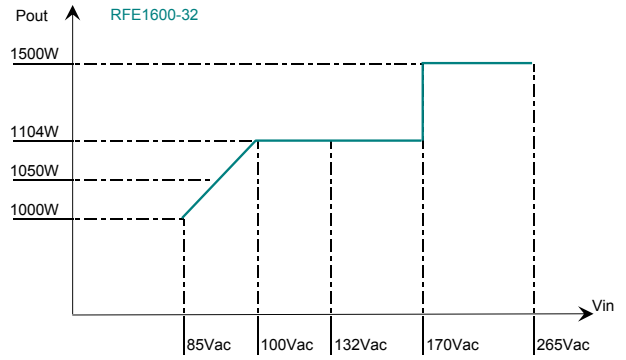

All Output Voltages
Fig A1. Output Power at temp -10~50°C.

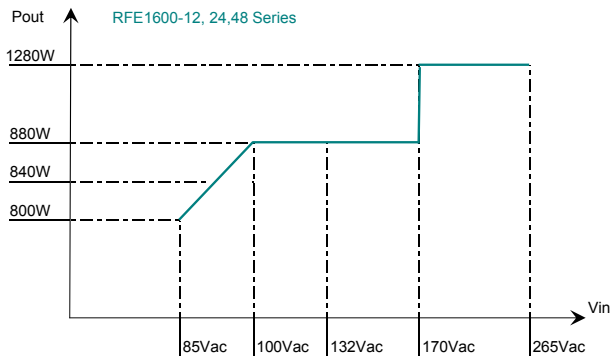

All Output Voltages
Fig B. Output Power derating at temp 60°C.

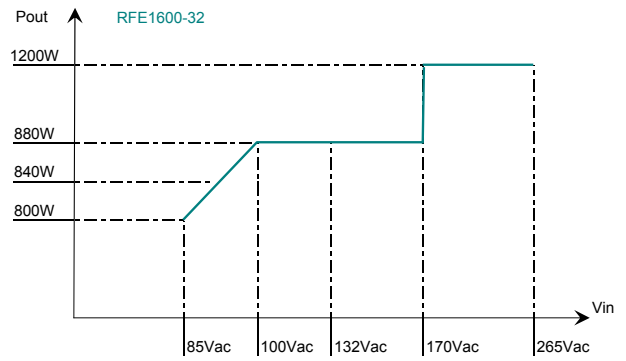

All Output Voltages
Fig B1. Output Power derating at temp 60°C.

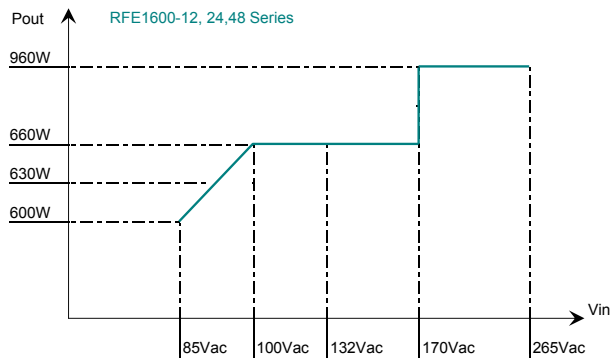

All Output Voltages
Fig C. Output Power derating at temp 70°C.

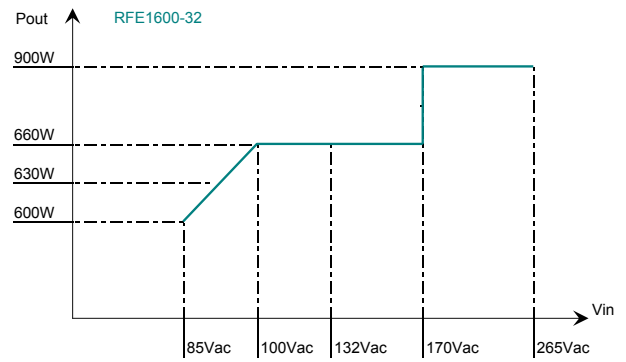

All Output Voltages
Fig C1. Output Power derating at temp 70°C.

RFE1600 Series Outline Drawing

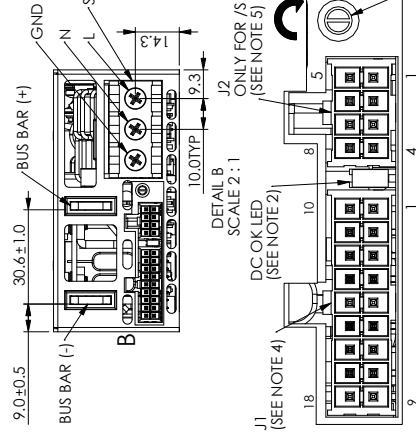
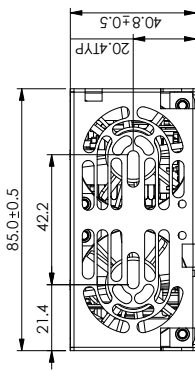
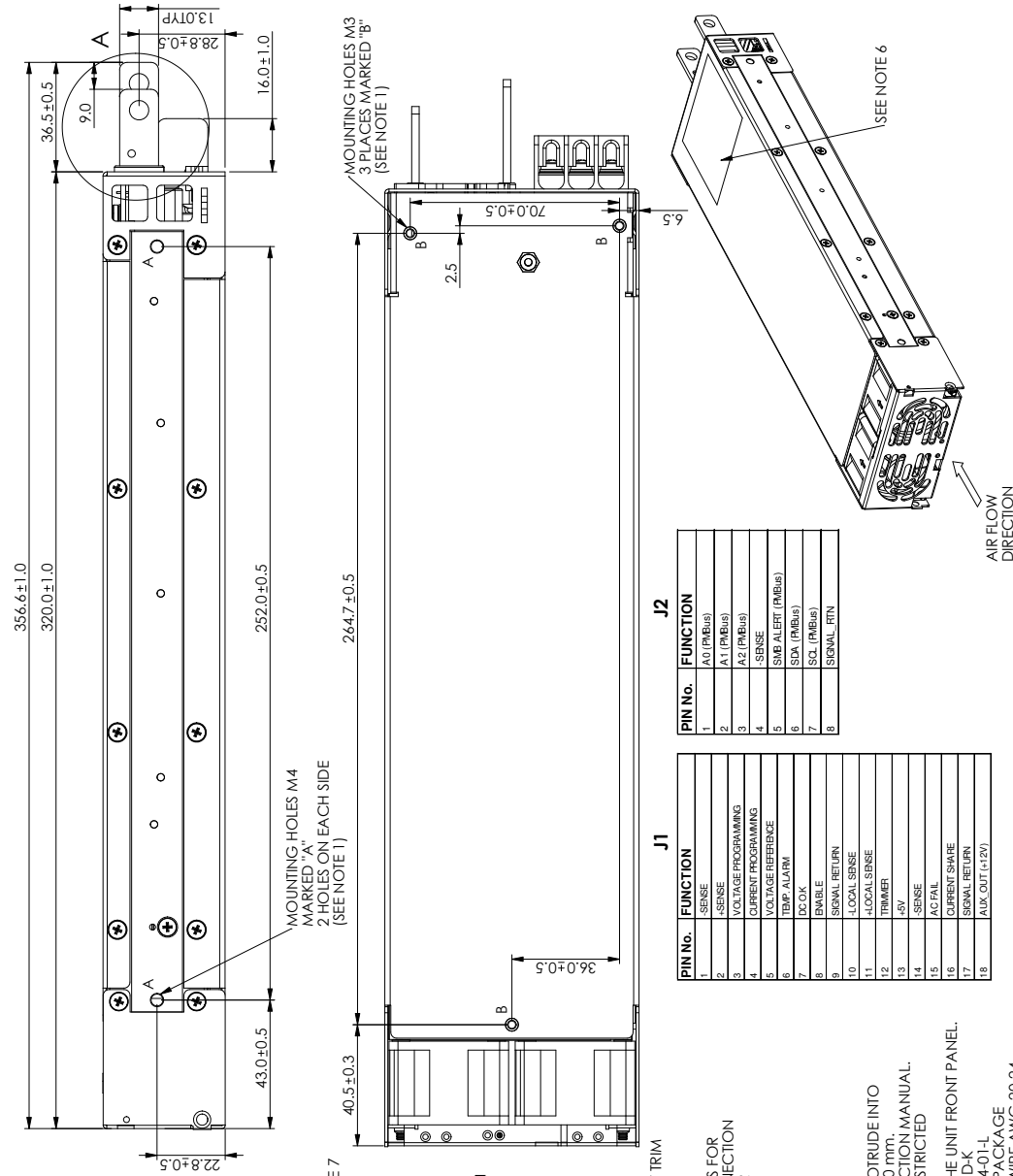

J2

PIN No.	FUNCTION
1	AC (PMBus)
2	A1 (PMBus)
3	A2 (PMBus)
4	-SENSE
5	SMB ALERT (PMBus)
6	SDA (PMBus)
7	SCL (PMBus)
8	SIGNAL RTN

J1

PIN No.	FUNCTION
1	-SENSE
2	-SENSE
3	VOLTAGE PROGRAMMING
4	CURRENT PROGRAMMING
5	VOLTAGE REFERENCE
6	TEMP ALARM
7	DC OK
8	ENABLE
9	SIGNAL RETURN
10	-LOCAL SENSE
11	-LOCAL SENSE
12	TRIMMER
13	-SENSE
14	-SENSE
15	AC FAIL
16	CURRENT SHARE
17	SIGNAL RETURN
18	AUX. OUT (+24V)

- NOTES:
1. MOUNTING SCREWS MUST NOT PROTRUDE INTO THE POWER SUPPLY MORE THAN 6.0 mm.
 2. LED INDICATORS. REFER TO INSTRUCTION MANUAL.
 3. ALLOW MINIMUM 50 mm OF UNRESTRICTED AIR SPACE AT THE REAR OF UNIT.
 4. DO NOT OBSTRUCT AIR FLOW TO THE UNIT FRONT PANEL.
 5. RECEPTACLE SAMTEC P/N PD1-09-DK CONN. CONTACT SAMTEC P/N PD1-09-DK PROVIDED AS ACCESSORY IN THE PACKAGE HAND TOOL: CAT#HT-179-2024-11 WIRE AWG 20-24 CONTACT PIN SAMTEC CC79L-2024-01-1 PROVIDED AS ACCESSORY IN THE PACKAGE HAND TOOL: CAT#HT-179-2024-11 WIRE AWG 20-24 RECEPTACLE SAMTEC P/N PD1-09-DK CONTACT PIN SAMTEC P/N PD1-09-DK PROVIDED AS ACCESSORY IN THE PACKAGE HAND TOOL: CAT#HT-179-2024-11 WIRE AWG 20-24
 6. MODEL NAME, INPUT AND OUTPUT RATING, REAR PANEL CONNECTORS, BUS BAR POLARITY DESCRIPTION AND SAFETY APPROVALS SYMBOLS ARE DESCRIBED ON TOP SURFACE LABEL
 7. USE UL APPROVED INSULATED TERMINAL LUGS

REAR PANEL OUTPUT CONNECTOR PINS FUNCTION DESCRIPTION OF J1

Pin #	Function	Description	Referenced to
J1-1, J1-14	Remote (-) SENSE	Negative sense, The -SENSE signal should be connected to -V on Power Supply, or Load side.	-SENSE
J1-2	Remote (+) SENSE	Positive sense. The +SENSE signal should be connected to +V on Power Supply, or Load side.	-SENSE
J1-3	VOLTAGE PROGRAMMING	Input (0~5V) referenced to -S. Provides Vout programming by Voltage. Refer to Instruction Manual	-SENSE
J1-4	CURRENT PROGRAMMING	Input (0~5V) referenced to -S. Provides Current programming by Voltage. Refer to Instruction Manual	-SENSE
J1-5	V_REF	Variable when Voltage/Current programming is done with PMBus option. Refer to Instruction Manual	-SENSE
J1-6	TEMP ALARM	TEMP ALARM signal. LOW when the internal temperature is within safe limit, HIGH approx. 10°C below Thermal shut down. Open collector type (15V, 10mA).	SIGNAL RETURN
J1-7	DC OK	DC OK signal. LOW when the output voltage is higher than 85~95% of Vout set. Open collector type (15V, 10mA).	SIGNAL RETURN
J1-8	ENABLE	Turns ON the main output by electrical signal or dry contact (0~0.6v or short).	SIGNAL RETURN
J1-9, J1-17	SIGNAL RETURN	Return for the following control signals: ENABLE, supervisory signals TEMP ALARM, AC FAIL, AUX and PMBus signals: SCL, SDA, SMB ALERT; SIGNAL RETURN and mentioned signals are isolated from the output terminals and -SENSE.	SIGNAL RETURN
J1-10	Local (-) SENSE	Positive Output Voltage (can not supply load current)	-V
J1-11	Local (+) SENSE	Negative Output Voltage (can not supply load current)	+V
J1-12	TRIMMER		-SENSE
J1-13	+5V	5V fix output for standard option unit.	-SENSE
J1-15	AC FAIL	Output AC FAIL, LOW when the input voltage is 85Vac<Vin<270Vac, HIGH when the input voltage is 85Vac>Vin or Vin>270Vac. Open collector type (15V, 10mA).	SIGNAL RETURN
J1-16	CURRENT SHARE	Current sharing signal should be connected when Power Supplies are connected in parallel to allow accurate current share between units in Parallel operation.	-SENSE
J1-18	+12V AUX OUT	11.2~12.5V Auxiliary Voltage Output referenced to SIGNAL RETURN. The maximum load current is 0.5A. This output has a built in ORing diode, and is not affected by the INHIBIT /ENABLE signal or any other fault.	SIGNAL RETURN

J2 - Optional PMBus interface

J2-1, J2-2, J2-3	A2, A1, A0 (optional PMBus)	PMBus Address lines. Refer to the PMBus interface description RFE Instruction Manual Chapter 3.	-SENSE
J2-4	Remote (-) SENSE	Negative sense, The -SENSE signal should be connected to -V on Power Supply, or Load side.	-SENSE
J2-5	SMB ALERT (optional PMBus)	PMBus INTERRUPT signal. Refer to the PMBus interface description RFE Instruction Manual.	SIGNAL RETURN
J2-6	SDA (optional PMBus)	Serial Data signal. Refer to the PMBus interface description RFE Instruction Manual.	SIGNAL RETURN
J2-7	SCL (optional PMBus)	Serial Clock signal. Refer to the PMBus interface description RFE Instruction Manual.	SIGNAL RETURN
J2-8	SIGNAL RETURN	Return for the following control signals: ENABLE supervisory signals TEMP ALARM, AC FAIL, AUX and PMBus signals: SCL, SDA, SMB ALERT; SIGNAL RETURN and mentioned signals are isolated from the output terminals and -SENSE.	SIGNAL RETURN

TB

Pin #	Function	Description
TB-1	AC LINE	AC LINE refer to safety instructions for safety standards requirements.
TB-2	AC NEUTRAL	AC NEUTRAL refer to safety instructions for safety standards requirements
TB-3	PROTECTIVE GROUND	AC GROUND connection. Refer to safety instructions for safety standards requirements

AC Connector

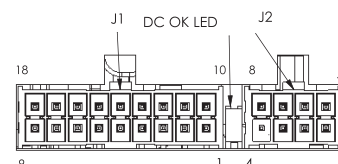
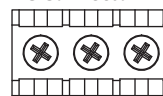

REGULATORY NOTICES

CE NOTICE (European Union)

Marking by the CE Symbol indicates compliance to the Low Voltage Directive (2006/95/EC) of the European Union. Such marking is indicative that the RFE1600-xy units meet the following technical standard: EN 60950-1:2006 - "Safety of Information Technology Equipment."

A "Declaration of Conformity" in accordance with the preceding directives and standards has been made and is on file at our EU representative TDK LAMBDA UK, located at Kingsley Avenue, Ilfracombe, Devon EX34 8ES, UK.

SAFETY APPROVALS

UL60950-1 Second Edition, UL Recognized, C-UL for Canada. IEC/EN 60950-1 Second Edition. CE marking, when applied to the RFE1600-xy units, indicates compliance with the Low Voltage Directive 2006/95/EC in that it complies with EN60950-1 Second Edition.

SAFETY INSTRUCTIONS

CAUTION: The following safety precaution must be observed during all phases of operation, service and repair of this equipment. Failure to comply with the safety precautions or warnings in this document violates safety standards of design, manufacture and intended use of this equipment and may impair the built-in protections within. TDK Lambda shall not be liable for user's failure to comply with these requirements.

Vorsicht

Die folgenden Sicherheitsvorschriften müssen vor Inbetriebnahme und in jedem Betriebszustand bei Service oder Reparatur beachtet werden. Missachtung der Sicherheitsvorschriften und Warnhinweise aus diesem Handbuch führen zur Verletzung der bestehenden Sicherheitsstandards. Bei Betrieb des Gerätes ausserhalb dem bestimmungsgemässen Einsatz können die im Gerät integrierten Schutzfunktionen beeinträchtigt werden. TDK-Lambda ist nicht haftbar für Schäden, die durch Missachtung dieser Sicherheitsvorschriften entstehen können.

CAUTION: RFE1600-xy units are not authorized for use as critical component in nuclear control systems, life support systems or equipment for use in hazardous environments without the express written approval of the managing director of TDK-Lambda.

Vorsicht

Dieses Produkt ist nicht für die Verwendung als kritische Komponente in nuklearen Steuerungssystemen, lebenserhaltenden Systemen oder Geräte für den Einsatz in gefährlichen Umgebungen, ohne die ausdrückliche schriftliche Genehmigung durch TDK-Lambda zugelassen

POWER SYSTEM, OVERVOLTAGE CATEGORY & ENVIRONMENTAL CONDITIONS

The RFE1600-xy units have been evaluated for using in TT and IT (230VAC line - to - line) power systems.

The RFE1600-xy units have been evaluated to Overvoltage category II.

The RFE1600-xy units intended for use in the following operation conditions:

* Indoor use * Pollution degree 2 * Max. operational altitude: 3000m above sea level

*Ambient temperature: -10°C-50°C at 100% load, up to 70°C with output de-rating applied (refer to Specification above).

GROUNDING

RFE1600-xy units are Class I product. To minimize electrical shock hazard, the RFE1600-xy units must be connected to an electrical ground. The instruments must be connected to the AC power supply mains through a three conductor power cable, with the ground wire firmly connected to an electrical ground (safety ground) at the power outlet. For instruments designed to be hard-wired to the supply mains, the protective earth terminal must be connected to the safety electrical ground before any other connection is made. Any interruption of the protective ground conductor or disconnection of the protective earth terminal will cause a potential shock hazard that might cause personal injury.

Erdungskonzept

Dieses Produkt ist ein Gerät der Schutzklasse 1. Zur Vermeidung von gefährlichen Energieinhalten und Spannungen, ist das Gehäuse an eine Schutz Erde anzuschliessen. Der PE-Anschluss ist an einen festen Erder anzuschliessen. Bei Festverdrahtung des Gerätes ist sicherzustellen, dass der PE Anschluss als erstes angeklemt wird. Jede mögliche Unterbrechung des PE-Leiters oder Trennung der PE Verbindung kann einen möglichen elektrischen Schlag hervorrufen, der Personenschäden zur Folge hätte.

LIVE CIRCUITS

Operating personnel must not remove the RFE1600-xy unit cover.

No internal adjustment or component replacement is allowed by non-TDK Lambda qualified service personnel. Never replace components with power cable connected. To avoid injuries, always disconnect power, discharge circuits and remove external voltage sources before touching components.

Restricted Access Area: RFE1600-xy units should only be installed in a Restricted Access Area. Access should be available to service personnel only.

Spannungsführende Teile

Die Geräteabdeckung darf nicht durch Endanwender geöffnet werden. Interne Modifikationen, sowie Bauteilaustausch ist nur durch TDK-Lambda qualifiziertes Personal erlaubt. Vor Austausch von Bauteilen ist das Netzkabel bzw. die Versorgungsspannung zu trennen. Energieversorgungsanschlüsse sind immer zu trennen, um Personenschäden durch gefährliche Energieinhalte und Spannungen auszuschliessen. Die Stromkreise sind zu entladen, externe Spannungsquellen sind zu entfernen, bevor auf Bauteile bzw. Komponenten Ebene gearbeitet wird.

PARTS SUBSTITUTIONS & MODIFICATIONS

Parts substitutions and modifications are authorized TDK Lambda service personnel only. For repairs or modifications, the instrument must be returned to TDK Lambda service facility.

AC INPUT

Do not connect RFE1600-xv unit to mains supply exceeding the input voltage and frequency rating. The input voltage and frequency rating is: 100-240V~, 50/60Hz. For safety reasons, the mains supply voltage fluctuations should not exceed ±10% of nominal voltage.

HEAT HAZARD

WARNING: Top, bottom and side surfaces may become hot when operating the unit continuously. To reduce the risk of injury from a hot surface, allow the surface to cool before touching.

Heisse Oberflächen

WARNUNG: Im Dauerbetrieb erwärmen sich die Gehäuseoberflächen. Um das Verletzungs-Risiko durch heiße Oberflächen zu minimieren, sollte das Gerät einige Zeit abkühlen können, bevor weitere Arbeiten durchgeführt werden.

ENERGY HAZARD

The main output of RFE1600-xy units is capable of providing hazardous energy. Due to hazardous energy level the output and connections therefore must not be user accessible. Manufacturer’s final equipment must provide protection to service personnel against inadvertent contact with output bus bars.

FUSE

Internal fuse is sized for fault protection and if a fuse was opened it would indicate that service is required. Fuse replacement should be made by qualified technical personnel.

RFE1600-xy unit fuse rating is described below. F101: T20A H 250Vac

SICHERUNGEN

Vor Anschluss an die Netzversorgung ist die Aufstellanleitung zu beachten!

1. Absicherung: F1 01: T20A H 250VAC
2. Die Gehäuseabdeckung darf nur im stromlosen Zustand geöffnet werden.

ACHTUNG: Sicherungen dürfen nur durch geschulte Service Personen getauscht werden.

OVERCURRENT PROTECTION:

A readily accessible branch circuit over-current protective device rated 30A max. must be incorporated in the building wiring.

The protective device must be disconnect both supply line simultaneously

Überstromschutz

Eine leicht zugängliche Vorsicherung mit 30A max.. pro Eingang muss in der Hausinstallation vorgesehen werden

SYMBOLS



VORSICHT Spannungsführende Teile-Gefahr durch elektrischen Schlag bzw. Energieinhalte.



Handbuch-Symbol. Das Gerät bzw. Geräteteile werden mit diesem Symbol gekennzeichnet, wenn es für den Benutzer notwendig ist, sich auf die Anweisungen im Handbuch zu beziehen.



Zeigt "spannungsführende Teile" mit gefährlicher Spannung an.



Dieses Symbol weist auf das Vorhandensein einer heißen Oberfläche oder Komponente. Das Berühren dieser Oberfläche kann zu Verletzungen führen.



Zeigt Masse-Anschluss an, keine Schutz Erde. (z.B .Masseanschluss an einen Verbraucher).



Schutzleiter-Anschlussklemme.

WARNUNG

Dieser Warnhinweis beschreibt Gefahren, deren Nichteinhaltung zu Personenschäden führen können. Die Warnhinweise müssen daher zwingend wie im Handbuch beschrieben in der Applikation eingehalten werden.

ACHTUNG

Diese Sicherheitsinformation weist auf Gefahren im täglichen Umgang mit dem Gerät hin, deren Missachtung zu Fehlfunktionen oder Defekten in deer Applikation führen können. Bitte lesen Sie diese Sicherheitsinformationen , bevor Sie das Gerät einbauen oder in Betrieb nehmen.

REAR PANEL INDICATORS

1. DC OK – LED indicator:

- GREEN when Output Voltage above $90\% \pm 5\%$ of set Output Voltage;
- OFF when Output Voltage fallen below $90\% \pm 5\%$ of set Output Voltage;

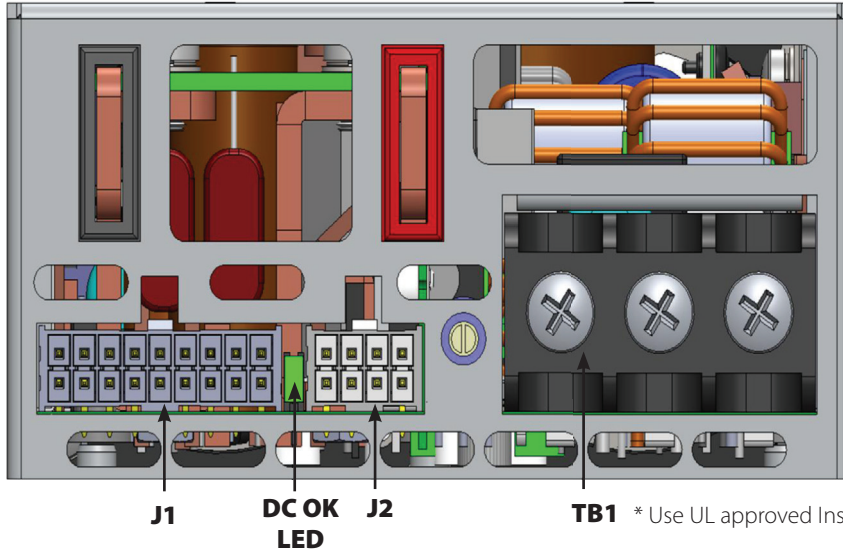

ATTENTION: Powe supplies are factory programmed to the rated output voltage. For applications requiring lower /higher voltage power supplies should be adjusted to the required voltage before connection to the load.

1. SINGLE UNIT OPERATION

1.1 Basic configuration (Local Sense)

For basic configuration:

- \pm SENSE have to be connected to the RFE1600 $\pm V$ terminals prior to operating the supply.
- ENABLE input must be connected to SIGNAL RETURN in order for the supply to turn on.

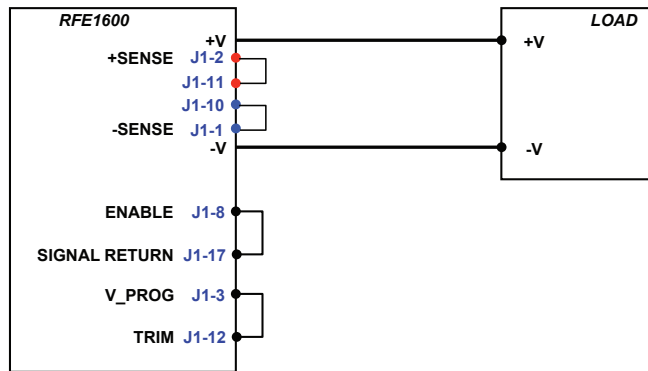

Fig-1.1

1.2 Basic configuration (Remote Sense)

For basic configuration:

- ± SENSE have to be connected to the ±V terminals on the Load side prior to operating the supply.
- ENABLE input must be connected to SIGNAL RETURN in order for the supply to turn on.

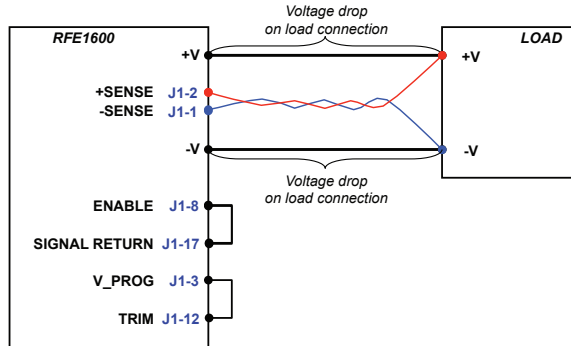

Fig-1.2

- ATTENTION:**
1. Maximum voltage drop on load connection: RFE1600-12: 0.25V/wire, RFE1600-24: 0.5V/wire, RFE1600-48: 1V/wire.
 2. Twisted wires should be used for Remote Sensing connection.
 3. If Remote Sensing is used do not break Main Output connection.

1.3 ON/OFF control by ENABLE

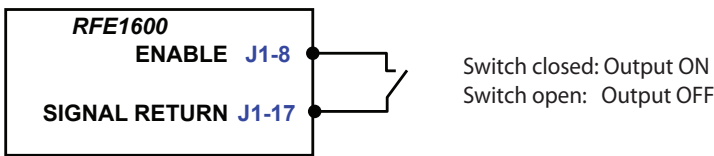

Fig-1.3 SIGNAL RETURN and ENABLE control are isolated from the output terminals and "-SENSE".

Power Supply operation requires the "ENABLE" signal to be connected to "Signal Return".

1.4 OUTPUT VOLTAGE PROGRAMMING by Built-in Potentiometer (Not applicable to supplies with PMBUS option).

Output Voltage of RFE1600 Series can be trimmed by potentiometer between approximately 80%-120% for 24V, 32V, 48V and 80%-110% for 12V of nominal output voltage (For Output voltage limits see Graph below).

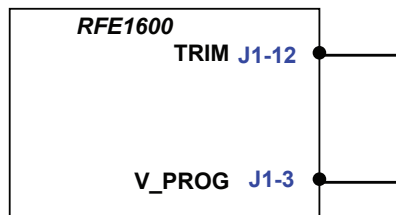

Fig-1.4

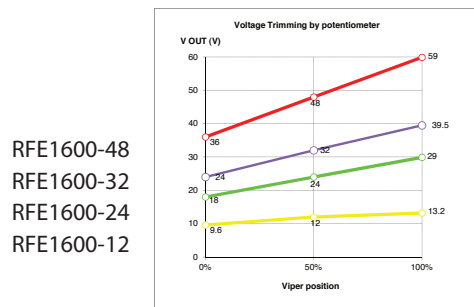

Fig 1-5

1.5 OVER CURRENT PROGRAMMING by External Voltage

Over Current Protection (OCP) can be programmed by external voltage source 0~5V. By changing the Current Programming Voltage OCP level could be decreased down to ~40% of Nominal Output Current.



Fig-1.5

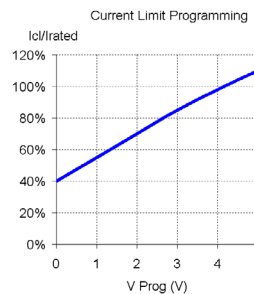

1.5.1 CURRENT PROGRAMMING by PMBUS

Over Current Protection (OCP) can be programmed by PMBUS with a range of 50% ~ 110% of Nominal Output Current.

ATTENTION: If PMBus is used for current programming, the Reference voltage will not be fixed to 5V but variable.

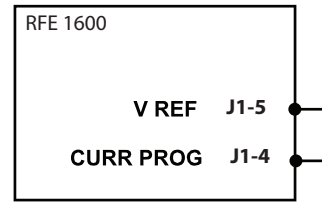

Fig-1.5.1

1.6. OUTPUT VOLTAGE PROGRAMMING by External Voltage.

Output Voltage of RFE1600 Series can be programmed by external voltage source between approximately 80%-120% for 24V, 48V and 80%-110% for 12V of nominal output voltage (For Output voltage limits see Graph enclosed).

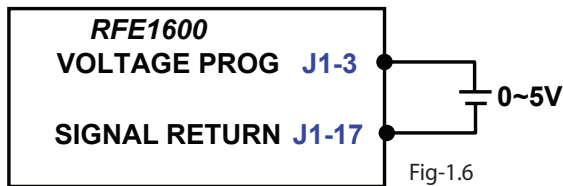

Fig-1.6

1.6.1 OUTPUT VOLTAGE PROGRAMMING by PMBus (optional).

Output Voltage of RFE1600 Series can be programmed by PMBus between approximately 80%-120% for 24V, 48V and 80%-110% for 12V of nominal output voltage. Refer to Fig. 1.6.1

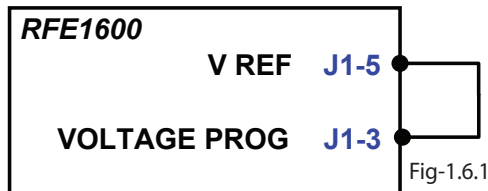
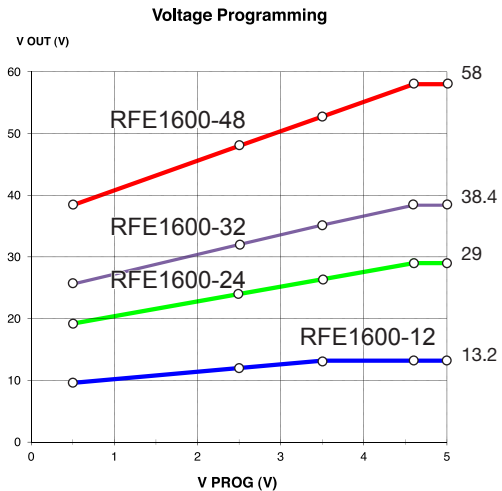

Fig-1.6.1



1.7 SUPERVISORY SIGNALS (Typical Connection)

The following supervisory signals are accessible:

- DC OK • AC FAIL • TEMP ALARM

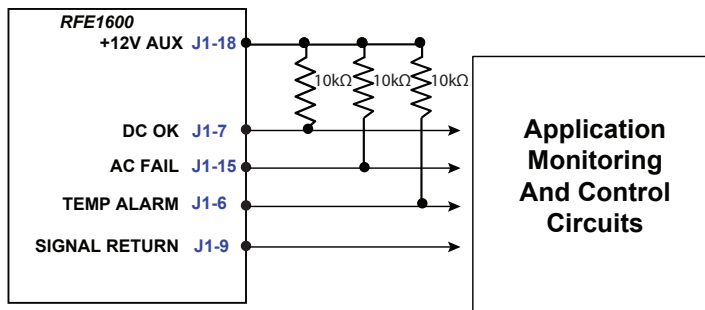

Fig-1.7 Open collector signals are shunted by internal 24V zener

1.8 SIGNAL RETURN and mentioned signals are isolated from the output terminals and -SENSE.

These signals are Open Collector type (max 15V, max 10mA), isolated from Output and referenced to "SIGNAL RETURN". Instead of 12V AUX, external Supply of 15V max could be used. Recommended Pull-up resistors for 5mA max.

All outputs are Open Collector type
(max 15V, max 10mA)

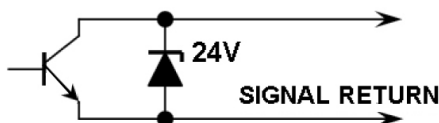
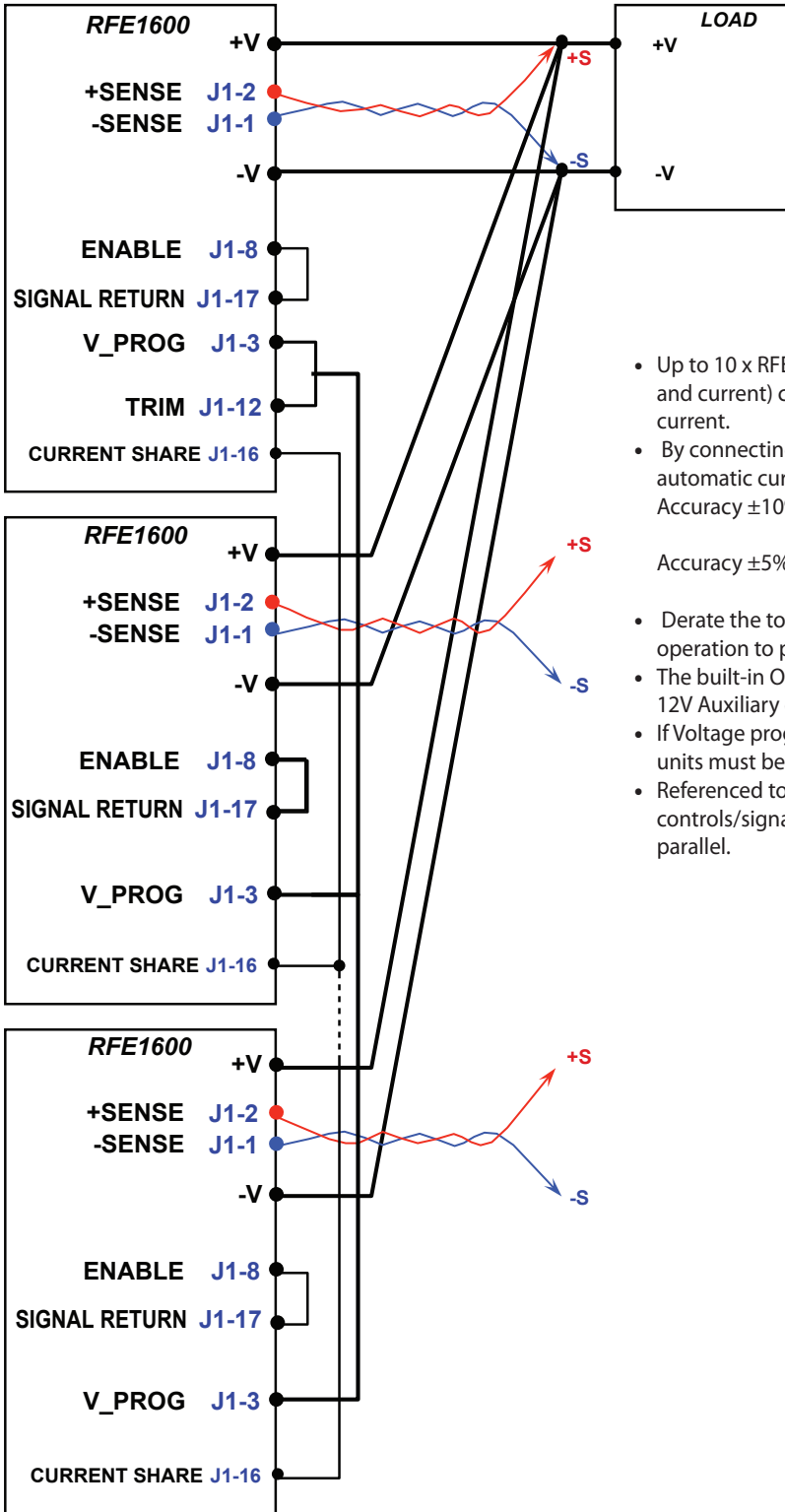

Fig-1.8

2. POWER SUPPLIES CONNECTION

2.1. PARALLEL OPERATION



- Up to 10 x RFE1600 units with the same rating (voltage and current) can be used in parallel to increase the output current.
- By connecting the CS signal between the paralleled units, automatic current balance is achieved with accuracy of

Accuracy $\pm 10\%$:	20% \leq I _{out} < 50% of max I _{out} .
	Up to 10 units
Accuracy $\pm 5\%$:	I _{out} \geq 50% of max I _{out} .
	Up to 10 units
- Derate the total output current by 5% when using parallel operation to prevent unit overload condition.
- The built-in ORing MOSFETs on the main output and the 12V Auxiliary output allow N+1 operation.
- If Voltage programming is used "V PROG" inputs of all units must be connected in parallel.
- Referenced to "SIGNAL RETURN" (floating from the output) controls/signals and +12V AUX can be connected in parallel.

Fig-2.1

2.2 SERIES OPERATION

- Up to 2 units with the same rating (voltage and current) can be used in series to increase the output voltage;
- Connect Main Outputs in series (as shown);
- Diodes should be connected in parallel with each unit output to prevent reverse voltage. Each diode should be rated to at least the power supply rated output voltage and output current.
- Connect as shown : +Sense of positive unit and –Sense of negative unit (twisted pair) to Load point, or to +V and –V accordingly for Local Sense;
- In case PMBus is used Connect PMBus signals in parallel (PMBus is isolated from Output), and choose for the units different Addresses (see chapter 3.1);
- Output Voltage can be adjusted independently for each unit.
- Controls Monitoring signals and +12V AUX are referenced to “SIGNAL RETURN” may be connected in parallel.

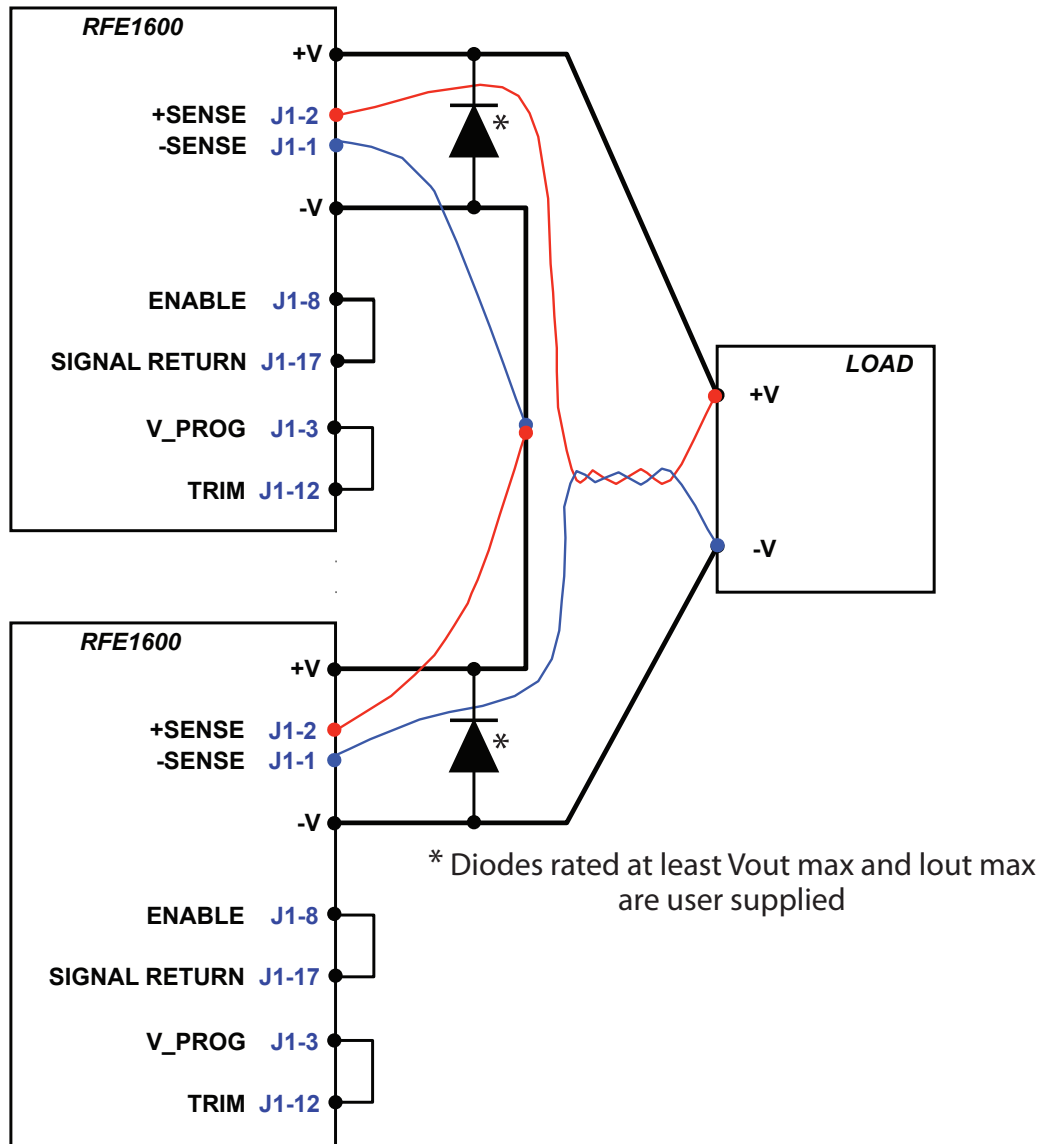

Fig 2.2 RFE1600 series connection (remote sense configuration)

RFE1600 SERIES I2C SPECIFICATIONS:

1. FEATURES

1.1	Output voltage measurement.
1.2	Output voltage programming.
1.3	Output current measurement.
1.4	Internal ambient temperature measurement.
1.5	Product information
1.6	Status information
1.7	SMBus alert
1.8	Clock frequency: 100KHz
1.9	Address lines: 3

1. OUTPUT VOLTAGE MEASUREMENT

			RFE1600-12/S	RFE1600-24/S	RFE1600-32/S	RFE1600-48/S
1.1	Measurement accuracy	-	+/-2% of full scale. Refer to instruction manual			
1.2	Measurement resolution	-	10 bit			
1.3	Measurement range (Full Scale)	V	0~15	0~30	0~40	0~60

2. OUTPUT VOLTAGE PROGRAMMING

			RFE1600-12/S	RFE1600-24/S	RFE1600-32/S	RFE1600-48/S
2.1	Programming accuracy	-	+/-2% of full scale			
2.2	Programming resolution	-	10 bit			
2.3	Programming range	V	9.6~13.2	19.2~29.0	25.6~38.4	38.4~58

3. OUTPUT CURRENT MEASUREMENT

			RFE1600-12/S	RFE1600-24/S	RFE1600-32/S	RFE1600-48/S
3.1	Measurement accuracy	-	+/-10% of full scale			
3.2	Measurement resolution	-	10 bit			
3.3	Measurement range (Full Scale)	A	0~160	0~80	0~60	0~40

4. INTERNAL AMBIENT TEMPERATURE MEASUREMENT (refer to Instruction Manual)

4.1	Measurement device accuracy	-	±3°C.			
4.2	Measurement resolution	-	10 bit			
4.3	Measurement range	°C	0~100			

5. PRODUCT INFORMATION

5.1	Factory programmed	-	Product ID			
5.2	Factory programmed	-	Model Name			
5.3	Factory programmed	-	Revision			
5.4	Factory programmed	-	Serial Number			
5.5	Factory programmed	-	Manufacturing location			
5.6	Factory programmed	-	Coefficients			
5.7	Factory programmed	-	Date of Manufacture			
5.8	Factory programmed	-	Nominal Output			

6. STATUS INFORMATION

6.1	"FAN FAIL" Signal	-	"1" -FAIL, "0"-OK			
6.2	"DC FAIL" Signal	-	"1" -FAIL, "0"-OK			
6.3	Output "OVP" Signal	-	"1" - OVP, "0"-OK			
6.4	"TEMPERATURE ALARM" signal	-	"1" - ALARM, "0"-OK			
6.5	"OTP" Signal	-	"1" -OTP, "0"-OK			
6.6	"AC FAIL" Signal	-	"1" -FAIL, "0"-OK			
6.7	I2C ON/OFF control	-	"1" -ON, "0"-OFF			
6.8	"SMB ALERT" signal	-	"1" -OK, "0"-ALERT			

3. PMBus Interface Option (/S Option)

The communications bus signals are powered by the external 3.3V power source pulled up with a 1.5kΩ resistor

3.1 RFE1600 may have optional Power Management Bus (PMBus) hardware.

The PMBUS interface in the RFE1600 (/S option) includes:

- Monitoring the Output Voltage, Current and Temperature
- Programming the Output Voltage and current
- Programming the Maximum allowed output Voltage
- Programming the Supply On/OFF.
- Reading and Clearing Faults.
- Reading the Manufacturing Related Data (Model Name, Serial No, Manufacturing Date, etc)
- Storing the following conditions at AC Off
 - Set Output voltage / current limit (OCP)
 - Max allowed programmable output voltage

ATTENTION: If PMBus is used for voltage or current programming, the reference voltage will not be fixed to 5V but can be variable. (Reference voltage will be used for voltage or current programming).

The PMBUS supports:

- 100KHz Operation.
- Block Read Protocol
- Group Command Protocol
- Direct Command Format for Monitoring and Programming Functions

3.2 Addressing (A2, A1, A0 inputs)

Three variable address lines allow up to 8 Supplies to be connected on a single bus.

PMBus uses 7 bit addressing.

There is constant part of address and variable part of address:

Constant part of address consists of 4 Most Significant Bits A6, A5, A4, A3 and always equals 0010.

Variable part of address consists of 3 Least Significant bits: A2, A1, A0.

Value of these three bits have to be assigned by hardware connections of 3 pins of the PS connectors.

The Address lines (A2, A1, A0) are internally pulled up by resistors to +5V.

The address lines can be left open for '1' address or connected to -S for '0' address.

So, available Address Space contains 8 possible addresses: from 0010000 to 0010111.

In case more than one unit is connected to PMBus, each unit must be set to its own unique address.

Duplicate addressing is not allowed.

- | | | |
|--------------|--|---------------------|
| For example: | first unit -- A2(J2-1), A1(J2-2), A0(J2-3) are not connected | – ADDRESS 0010 111; |
| | second unit -- A0(J2-3) is connected to -SENSE | – ADDRESS 0010 110; |
| | third unit – A1(J2-2) is connected to -SENSE | – ADDRESS 0010 101; |
| | and so on. | |

Attention: **A2, A1, A0 signals and -SENSE are NOT isolated from the Output Terminals.**

Hot Plug: **When hot plugging a power supply into a live system, the supply takes about 1-2 seconds to configure its address on the bus (based on the analog voltage levels present on the back plane).**

3.3 SERIAL CLOCK

This line is clocked by the Controller which controls the PMBUS. It should be connected to +3.3V (referenced to "Signal RTN") via a 1.5kΩ pull-up resistor.

3.4 SERIAL DATA

This is a Bi-Directional line which must be connected to +3.3V (referenced to Signal RTN) via a 1.5kΩ pull up resistor.

3.5 SMB ALERT

SMB ALERT is used to indicate to the HOST about any Faults/Error Conditions.

This line must be connected to +3.3V (referenced to Signal RTN) via a 1.5kΩ pull up resistor.

This Signal is HIGH to indicate that no fault/error is present. If some fault/error occurs, the signal will go LOW.

The Host system must poll multiple supplies after receiving SMB ALERT to retrieve fault/warning information.

3.6 PMBus TYPICAL CONNECTION

"SIGNAL RETURN" and PMBus signals are isolated from the Output terminals and Senses.

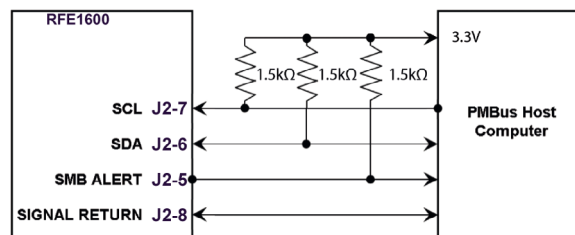

Fig-3.6 PMBus Typical connection

4. PMBus COMMAND SET

The interval between two consecutive commands to the power supply should be at least 25ms to ensure proper monitoring functionality

4.1 READ_STATUS

This Command is used to read the status of the Power Supply. The Status information is stored in a special register called the "STATUS REGISTER".

The PMBUS reads 8 different types of Faults and Warnings.

Command Used	Type	#Data bytes
D0h	Read Byte	1

Fault is indicated by "1". No fault is indicated by "0".

For Example: If DC Fail occurs, READ_STATUS will return 01h. SMB ALERT will go "LOW"

If AC Fail occurs, READ_STATUS will return 11h. SMB ALERT will go "LOW"

Faults	Type	Bit No in Status Register	Meaning	Main output behavior
DC Fail	FAULT	0	Output Voltage < 85~95% of Set Vout	Output OFF/Output Low
Over Temperature Protection	FAULT	1	Internal temperature higher than safe limit	Output OFF
Over Temperature Alarm	WARNING	2	Internal temperature ~ 10°C below safe limit.	Output ON
Fan Fail	FAULT	3	One or both Fans are not working	Output OFF
AC Fail	FAULT	4	Input Voltage <85Vac / >270Vac	Output OFF/Output ON
Over Voltage Protection	FAULT	5	Output Voltage > 1.15xVset	Output OFF
Programmed Voltage more than allowed	WARNING	6	Programmed Voltage more than Max Allowed Voltage (*1)	Output ON
Command Error	WARNING	7	Command not understood by Power Supply (*2)	Output ON

(*1) If Max Allowed Voltage is set to 48V and Programmed Voltage is set to 50V, Output will be programmed to 48V, Bit No 6 will be "1", and SMB ALERT will become "LOW".

(*2) If any Command sent is not understood by the Supply, bit no 7 will be "1" and SMB ALERT will become "LOW".

4.2 CLEAR_FAULTS

This command is used to clear the "STATUS REGISTER" after any fault occurs.

If the CLEAR_FAULTS command is not sent after any fault occurs, the "STATUS REGISTER" will not be cleared.

SMB ALERT signal will remain "LOW" until a "CLEAR_FAULTS" command is sent.

If a Fault or Warning is still present after "CLEAR_FAULTS" is sent, "STATUS REGISTER" will be updated and the SMB ALERT signal will be "LOW" again.

Command code	Type	#Data bytes
03h	Send Byte	0

4.3 OPERATION (ON/OFF)

Command code	Type	Data sent
01h	R/W Byte	00h=OFF
01h	R/W Byte	80h=ON

If the Power Supply is turned OFF with the "OPERATION OFF" command, the Supply can be turned ON with the "OPERATION ON" command only. Inhibit and Enable signals are disabled.

4.4 COMMANDS TO READ INVENTORY DETAILS

Command Name	Command code	Type	#Data bytes
PMBUS_REVISION	98h	Read Byte	1
MFR_ID	99h	Read Block	16
MFR_MODEL	9Ah	Read Block	16
MFR_OUTPUT	D1h	Read Block	16
MFR_REVISION	9Bh	Read Block	16
MFR_LOCATION	9Ch	Read Block	16
MFR_DATE	9Dh	Read Block	16
MFR_SERIAL	9Eh	Read Block	20

All details except for <PMBUS_REVISION> are stored in ASCII format.

4.5 PROGRAMMING AND MONITORING FUNCTIONS

For Monitoring and Programming functions use the following equation

$$Y = (mX + b) * 10^R \quad X = (Y * 10^{-R} - b) / m$$

Where **Y** - digital value sent or received from the supply.
X is the normal value (V, A, °C)
m, b, R - coefficients that are explained in Table 1.

Table 1

Voltage (V)	Physical value	Physical Unit	Min. Value	Max. Value	m	b	R
48	Voltage Programming	V	38.4	58	426	-15335	-1
	Voltage monitoring	V	0	60	1705	0	-2
	Current monitoring	A	0	40	25575	0	-3
	Temperature monitoring	°C	0	100	1023	0	-2
32	Voltage Programming	V	28.8	38.4	639	-15333	-1
	Voltage monitoring	V	0	40	25575	0	-3
	Current monitoring	A	0	60	1705	0	-2
	Temperature monitoring	°C	0	100	1023	0	-2
24	Voltage Programming	V	19.2	29	853	-15360	-1
	Voltage monitoring	V	0	30	341	0	-1
	Current monitoring	A	0	80	12787	0	-3
	Temperature monitoring	°C	0	100	1023	0	-2
12	Voltage Programming	V	9.6	13.2	1705	-15345	-1
	Voltage monitoring	V	0	15	682	0	-1
	Current monitoring	A	0	160	6394	0	-3
	Temperature monitoring	°C	0	100	1023	0	-2
12, 24, 32, 48	Current Programming	%	50	110	146	-5830	-1

m, b, R coefficients can also be recovered from the EEPROM
coefficients are stored in ASCII Format

Command name	Command code	Type	#Data bytes
MFR_VOLTAGE_MON_COEFF	D2h	Read Block	16
MFR_CURRENT_MON_COEFF	D3h	Read Block	16
MFR_TEMP_MON_COEFF	D4h	Read Block	16
MFR_VOLTAGE_PROG_COEFF	D5h	Read Block	17
MFR_CURRENT_PROG_COEFF	D7h	Read Block	16

4.5.1 MONITORING THE OUTPUT VOLTAGE (READ_VOUT)

The accuracy of the voltage reading is +/-2%

The output voltage is read before the ORING Circuit (~50mV Voltage drop @ load, no drop @no load).

The read back Output Voltage can be calculated using the "Direct data Format".

Refer to Table 1 for the Coefficients for calculating the Output Voltage.

Command code	Type	#Data bytes
8Bh	Read Word	2

Example: Power Supply RFE1600-48;

Hex read back = 032Ch;

Converted to Decimal = 812;

Using the required coefficients the Output Voltage $812 \times 100 / 1705 = 47.62V$.

Read the Actual Output Voltage on the Output Bus Bar (Ex: 47.90V). Add 0.05V to compensate ORing Circuit drop

So, the actual voltage is (Ex: $47.90 + 0.05 = 47.95V$).

Accuracy is $(47.95 - 47.62) / 60 (*1) \times 100 = 0.55\%$

Supply (*1)	Full Scale (*1)
RFE1600-12	15V
RFE1600-24	30V
RFE1600-32	40V
RFE1600-48	60V

4.5.2 MONITORING THE OUTPUT CURRENT (READ_IOUT)

The accuracy of the current reading is +/-10%

The read back output current can be calculated using the "Direct data Format".

Refer to Table 1 for the Coefficients for calculating the Output Current.

Command Used	Type	#Data bytes
8Ch	Read Word	2

Example: Hex read back = 0361h;

Converted to Decimal = 865;

Using the required coefficients the output current = $865 \times 1000 / 25575 = 33.82A$;

Read the actual Output current (Ex: 33.05A) / Accuracy is $(33.05 - 33.82) / 40 \times 100 = -1.92\%$

Supply (*1)	Full Scale (*1)	Supply (*1)	Full Scale (*1)
RFE1600-12	160A	RFE1600-32	60A
RFE1600-24	80A	RFE1600-48	40A

4.5.3 MONITORING THE SUPPLY TEMPERATURE (READ_TEMPERATURE_1)

The accuracy of the Temperature reading is +/-5°C

The read back supply temperature can be calculated using the "Direct data Format".

Please refer to table 1 for the Coefficients for calculating the Supply Temperature

Command Used	Type	#Data bytes
8Dh	Read Word	2

Example: Hex read back = 01DCh;

Converted to Decimal = 476;

Using the required coefficients the Supply Internal Temperature = $476 \times 100 / 1023 = 46.53°C$.

4.5.4 PROGRAMMING THE OUTPUT VOLTAGE (VOUT_COMMAND) (please refer to pg. 10, Fig 1.61)

The accuracy of the Output Voltage Programming is +/-2%

The output Voltage can be programmed using the "Direct data Format".

Please refer to table 1 for the Coefficients to be used for calculating the Voltage Programming.

Command Used	Type	#Data bytes
21h	R/W Word	2

Example: Power Supply RFE1600-24;

To program the Output Voltage to 24V, send $(853 \times 24 + (-15360)) / 10 = 511$ (DEC);

Read the actual set output Voltage (Ex: 24.05V) / Accuracy is $(24.05 - 24) / 30 \times 100 = 0.16\%$

Supply (*1)	Full Scale (*1)	Supply (*1)	Full Scale (*1)
RFE1600-12	15V	RFE1600-32	40V
RFE1600-24	30V	RFE1600-48	60V

4.5.5 PROGRAMMING THE MAXIMUM ALLOWED PROGRAMMABLE OUTPUT VOLTAGE (VOUT_MAX)

The output Voltage can be programmed using the "Direct data Format".

Please refer to table 1 for the Coefficients to be used for calculating the Voltage Programming.

Command Used	Type	#Data bytes
24h	R/W Word	2

4.5.6 PROGRAMMING THE OUTPUT CURRENT LIMIT (please refer to pg. 10, Fig 1.5.1)

The accuracy of the Current Limit Programming is +/-5%

It is possible to program the OCP with the PMBUS. The OCP can be programmed between 50% to 110% of the nominal load current.

Please refer to Fig 1.5.1 for the current limits at respective levels

The output Current can be programmed using the "Direct data Format".

Please refer to table 1 for the Coefficients to be used for calculating the Current Programming.

Please refer to Fig 1.5.1 for setup of Current programming

During Current programming, Vout_Max must be programmed to maximum limit.

Command Used	Type	#Data bytes
21h	R/W Word	2

Important: When using the PMBUS to program the current limit, the output voltage is set to the rated value as a default.

To set the output voltage to different level, Please refer to Pg.10 paragraph 1.5.1 or 1.6.1

Example:

Power Supply RFE1600-48;

To program the Current Limit to 100%, send $(146 \times 100 + (-5830)) / 10 = 877$ (DEC);

Read the actual Current (Ex: 32.5A) / Accuracy is $(32.5 - 33) / 40 (*1) \times 100 = -1.25\%$.

Supply (*1)	Full Scale (*1)	Supply (*1)	Full Scale (*1)
RFE1600-12	160A	RFE1600-32	60A
RFE1600-24	80A	RFE1600-48	40A

