

HAKKO FM-206

REWORK SYSTEM

Multi Rework Station

Instruction Manual

Thank you for purchasing HAKKO FM-206 Rework System.
Please read this manual before operating the HAKKO FM-206.
Keep this manual readily accessible for reference.

1. PACKING LIST

Please check to make sure that all items listed below are included in the package.

| | | | |
|--------------|---|--------------------|---|
| HAKKO FM-206 | 1 | Tip tray | 1 |
| Power cord | 1 | Instruction manual | 1 |

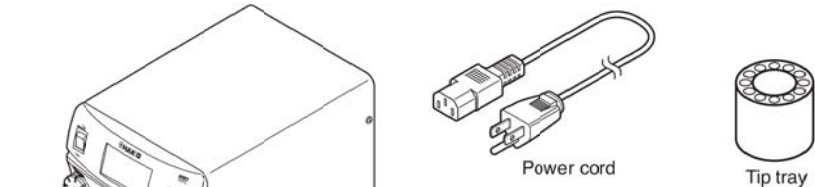

HAKKO FM-206

*The handpieces other than HAKKO FM-2027 have each instruction manual. Regarding the specification or way of replacing the parts, refer to each instruction manual.

2. SPECIFICATIONS

| | |
|-----------------------|--|
| Power Consumption | MAX 410W |
| Temperature Range | HAKKO FM-2026/2027 200 - 450°C (400 - 840°F) MODEL FM-2022/2023 200 - 400°C (400 - 750°F) MODEL FM-2024 350 - 450°C (660 - 840°F) HAKKO FM-2029 100 - 550°C (200 - 1030°F) HAKKO FM-2030 300 - 500°C (400 - 930°F) |
| Temperature Stability | ±5°C (±9°F) at idle temperature |

| | |
|------------------------|---|
| Output | 24V |
| Dimensions (W x H x D) | 162 x 136 x 245 mm (6.4 x 5.4 x 9.7 in) |
| Weight | 6.2 kg (13.7 lb.) |
| Capacity (Max) | 6L/min. |
| Vacuum Generator | Vacuum pump, cylinder type |
| Vacuum Pressure (Max.) | 80kpa (600 mm Hg) (24 in. Hg) |
| Suction Flow | 14L/min. |

● HAKKO FM-2027

| | |
|--------------------------|---|
| Power Consumption | 70 W (24 V) |
| Tip to Ground Resistance | < 2 Ω |
| Tip to Ground Potential | < 2 mV |
| Cord | 1.2 m (4 ft) |
| Total Length (w/o cord) | 188 mm (7.4 in.) with 2.4D tip |
| Weight (w/o cord) | 30 g (0.067 lb./1.07 oz.) with 2.4D tip |

* The temperature was measured using the HAKKO FG-101 thermometer.
* This product is protected against electrostatic discharge.
* Specifications and design are subject to change without notice.

■ Electrostatic Protection

This product includes such features as electrically conductive plastic parts and grounding of the handpiece and station as measures to protect the device to be soldered from the effects of static electricity. Be sure to observe the following instructions:

- The handle and other plastic parts are not insulators, they are conductors. When making repairs or replacing parts, take sufficient care not to expose live electrical parts or damage insulation materials.
- Be sure to ground the unit during use.

※ 各言語（日本語、英語、中国語、フランス語、ドイツ語、韓国語）の取扱説明書は以下のURL、HAKKO Document Portalからダウンロードしてご覧いただけます。
（商品によっては設定の無い言語がありますが、ご了承ください）
• 各言語（日本語、英語、中文、法語、ドイツ語、韓国語）の使用説明書は以下のURLのHAKKO Document Portal 下载参阅。
（有一部分的产品没有设定外语对应，请见注）
• Instruction manual in the language of Japanese, English, Chinese, French, German and Korean can be downloaded from the HAKKO Document Portal.
（Please note that some languages may not be available depending on the product.）

<https://doc.hakko.com>

中國RoHS: 產品中有毒有害物質或元素的名稱及含量

| 部件名稱 | 有毒有害物質或元素 | | | | | |
|-------|-----------|-------|-------|-------------|----------|------------|
| | 鉛(Pb) | 鎘(Cd) | 鎳(Ni) | 六價鉻(Cr(VI)) | 多環聯苯(PB) | 多環二苯基(PBR) |
| 連接部 | × | ○ | ○ | ○ | ○ | ○ |
| 隔離器 | × | ○ | ○ | ○ | ○ | ○ |
| 電路板 | × | ○ | ○ | ○ | ○ | ○ |
| 插座 | × | ○ | ○ | ○ | ○ | ○ |
| 電磁蓋 | × | ○ | ○ | ○ | ○ | ○ |
| 真空泵組件 | × | ○ | ○ | ○ | ○ | ○ |
| 螺絲 | × | ○ | ○ | ○ | ○ | ○ |
| 坦克組件 | × | ○ | ○ | ○ | ○ | ○ |
| 排出閥門 | × | ○ | ○ | ○ | ○ | ○ |

○: 表示該有毒有害物質在該部件所有均質材料中的含量均在SJ/T 11363-2006標準規定的限量要求以下。
×: 表示該有毒有害物質在該部件的某一均質材料中的含量超出SJ/T 11363-2006標準規定的限量要求。

HAKKO CORPORATION
HEAD OFFICE
TEL: +81-9-6561-3225 FAX: +81-9-6561-8466
<http://www.hakko.com> E-mail: sales@hakko.com

OVERSEAS AFFILIATES
U.S.A.: AMERICAN HAKKO PRODUCTS, INC.
TEL: (661) 294-0090 FAX: (661) 294-0096
Toll Free (800)88-HAKKO
<http://www.hakkousa.com>

HONG KONG: HAKKO DEVELOPMENT CO., LTD.
TEL: 2811-6588 FAX: 2590-0217
<http://www.hakko.com.hk>
E-mail: info@hakko.com.hk

SINGAPORE: HAKKO PRODUCTS PTE. LTD.
TEL: 6748-6277 FAX: 6744-0033
<http://www.hakko.com.sg>
E-mail: sales@hakko.com.sg

Please access to the following address for the other Sales affiliates.
<http://www.hakko.com>

3. WARNINGS, CAUTIONS, NOTES AND EXAMPLES

Warnings, cautions and notes are placed at critical points in this manual to direct the operator's attention to significant items. They are defined as follows:

- WARNING:** Failure to comply with a WARNING may result in serious injury or death.
 - CAUTION:** Failure to comply with a CAUTION may result in injury to the operator, or damage to the items involved.
- NOTE:** A NOTE indicates a procedure or point that is important to the process being described.

⚠ CAUTION

When power is ON, the tip will be hot. To avoid injury or damage to personnel and items in the work area, observe the following:

- Do not touch the tip or the metal parts near the tip.
- Do not allow the tip to come close to, or touch, flammable materials.
- Inform others in the area that the unit is hot and should not be touched.
- Turn the power off when not in use, or left unattended.
- Turn the power off when connecting the handpieces or storing the HAKKO FM-206.
- This appliance is not intended for use by persons (including children) with reduced physical, sensory or mental capabilities, or lack of experience and knowledge, unless they have been given supervision or instruction concerning use of the appliance by a person responsible for their safety.
- Children should be supervised to ensure that they do not play with the appliance.

● To prevent accidents or damage to the HAKKO FM-206, be sure to observe the following:

- Do not use the HAKKO FM-206 for applications other than soldering.
- Do not strike the iron against hard objects to remove excess solder. This will damage the iron.
- Do not modify the HAKKO FM-206.
- Use only genuine Hakko replacement parts.
- Do not allow the HAKKO FM-206 to become wet, or use it with wet hands.
- Remove power and iron cords by holding the plug – not the wires.
- Be sure the work area is well ventilated. Soldering produces smoke.
- While using HAKKO FM-206, don't do anything which may cause bodily harm or physical damage.

4. INITIAL SETUP

■ Part Names

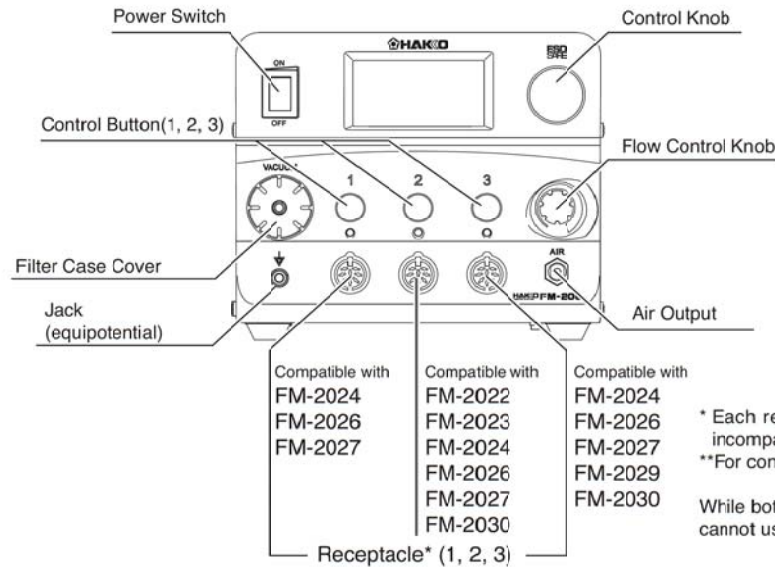

■ Setup

● Hooking up the iron and connecting cable.

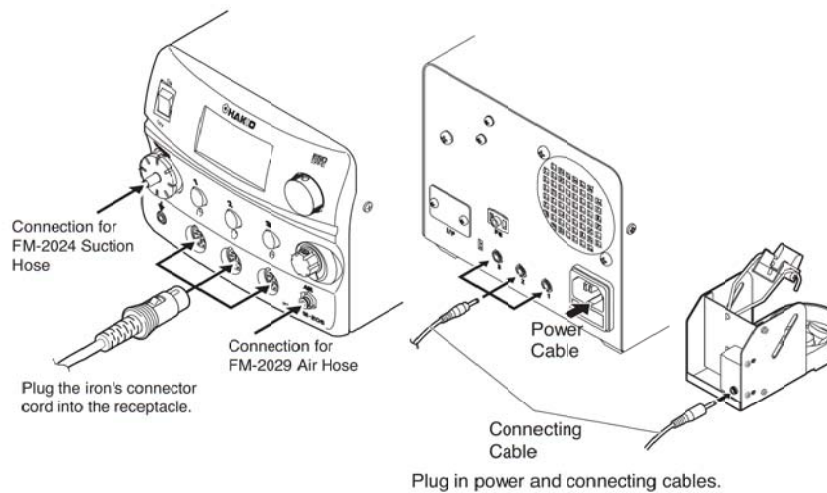

⚠ CAUTION

- Please make sure the power is off when you plug in cables.
- Please make sure to hook up the connector cable and the iron holder on the same channel and not to place the iron in a holder connected to a differing channel.
- Please take care not to mix up the hose connections, the MODEL FM-2024 connects to the filter case cover and the HAKKO FM-2029 to the air output.
- Securely insert the connecting cable all the way in to the jack.

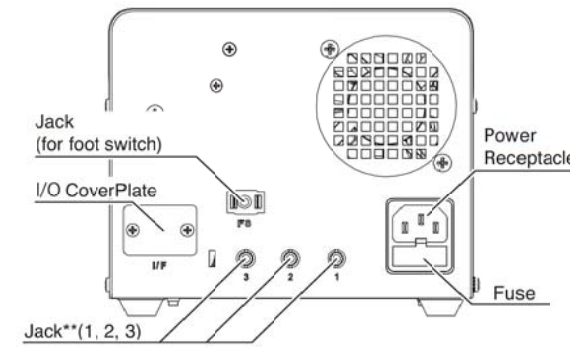

* Each receptacle connector differs, please be careful not to connect an incompatible device. Errors will result.
**For connecting iron holders. Make sure to connect the correct holder.

While both vacuum and hot air can be used, only one can be operated at once. One cannot use a combination of hot air and vacuum or two vacuums simultaneously.

● Replacing the tip (HAKKO FM-2027)

⚠ CAUTION

The tip may be hot. Avoid holding the hot tip for a long time even if using the heat-resistant pad. Otherwise burns may result.

Removing the tip:

- Hold down the lock release buttons in the sleeve assembly, pull out the tip together with the sleeve assembly from the connector.

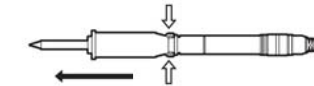

⚠ CAUTION

- Be sure to keep the lock release buttons held down while pulling out the sleeve assembly. Failure to do so will damage the locking mechanism.
- Be sure to pull out the tip only after separating the sleeve assembly from the connector. Otherwise, the sleeve assembly may fall down and break.

- While holding the front end of the sleeve assembly, pull out the tip.

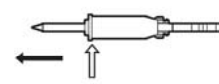

Insert the tip:

- Reassemble in the reverse order of disassembly.

⚠ CAUTION

- Insert the tip into the sleeve assembly until it clicks into place. When you hear it clicks, avoid forcing the tip into the sleeve assembly.
- When holding the head of the tip, there is a danger of burn. Be sure to use the heat-resistant pad.

*The handpieces other than HAKKO FM-2027 have each instruction manual. Regarding the specification or way of replacing the parts, refer to each instruction manual.

■ Switch, Control Button and Knob Usage

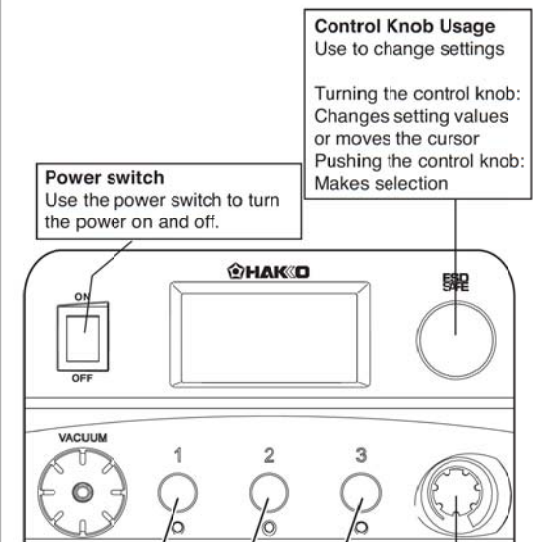

Control Knob Usage

Use to change settings
Turning the control knob:
Changes setting values or moves the cursor
Pushing the control knob:
Makes selection

Power switch

Use the power switch to turn the power on and off.

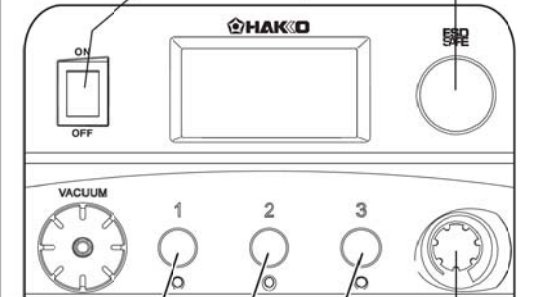

Control Buttons

Use to change settings such as temperature.

When pressed briefly:
Displays the preset screen.
When pressed and held:
Displays the change settings screen.

Change Settings Screen Details

- Temperature Settings
- Offset Settings
- Preset Temperature Settings
- Preset Names
- Channel Power (On/Off)
- Exit

Flow Control Knob

When HAKKO FM-2029 is connected to HAKKO FM-206, air flow will be displayed. By turning around the flow control knob, air flow can be changed. You can confirm how the hot air is discharged.

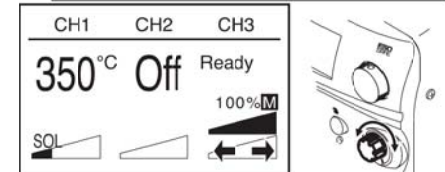

* If you press a control button while on the Preset or Change Settings screen, the corresponding channel screen will be displayed.

Plugged in irons will be heated according to the settings when the power is turned on.

5. OPERATION

■ Various setting changes (Preset select)

● Range of preset temperatures

Initial preset temperatures for each grip

| Grip | Initial Value |
|-------------------------|-------------------------------|
| HAKKO FM-2027 | 300.350/400°C (570/660/750°F) |
| MODEL FM-2022 / FM-2023 | 300.350/400°C (570/660/750°F) |
| MODEL FM-2024 | 350.375/400°C (660/700/750°F) |
| HAKKO FM-2030 | 300.350/400°C (570/660/750°F) |
| HAKKO FM-2029 | 300.350/400°C (570/660/750°F) |

* When the acceptable setting range is exceeded it will return to the initial setting.
(For the setting range, refer to "Initial preset temperatures for each grip.")

**The setting temperature, offset temperature, preset temperature, and preset name are remembered by each grip.

● Selecting the Preset Temperature

1. Press the operating knob for the channel you want to change.

The display screen will switch to the preset selection screen shown below.

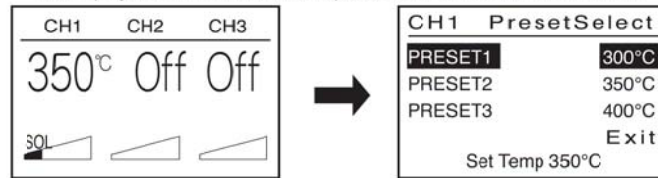

2. By turning the operating knob, the preset temperature to be selected will change.

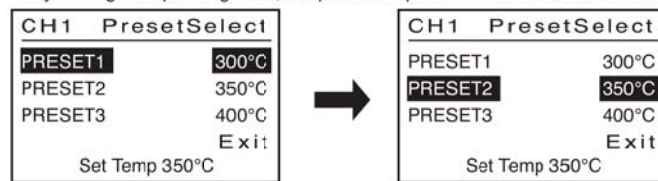

3. Press the operation knob when the cursor is on the desired preset temperature.

The iron tip will now be controlled by the selected preset temperature.

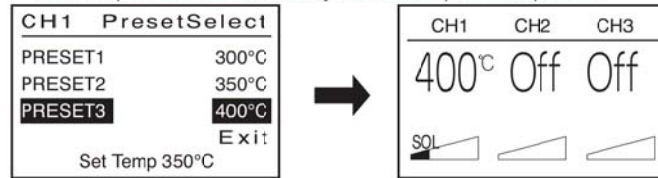

* Should you press another operating button while in the preset selection screen, it will shift to that channel's preset selection screen if the unit is in operation, and it will return to the screen before the preset selection screen if the unit is not in operation.

■ Changing various settings (other than preset selections)

● Setting items, possible change range and initial value

Items that can be changed during normal operation and initial setting

| | Possible Change Range | Initial Value |
|-------------|--|-----------------------------|
| Set Temp | Refer to "Temperature ranges for each grip." | 350°C (750°F) |
| Offset Temp | +/- 50°C (+/- 90°F) | 0°C (0°F) |
| Preset Temp | Refer to "Temperature ranges for each grip." | (Varies by grip) |
| Preset ID | Input up to 7 characters (English numerals + '_'). | PRESET1 / PRESET2 / PRESET3 |
| CH Power | ON / OFF | ON |

*Regarding the Hot Air (HAKKO FM-2029), there are other setting items. For details, please refer to "Settings that can be changed during normal operation of the Hot Air."

Temperature range for each grip

| Grip | Setting Temperature Range |
|-------------------------|---------------------------|
| HAKKO FM-2027 | 200~450°C (400~840°F) |
| MODEL FM-2022 / FM-2023 | 200~400°C (400~750°F) |
| HAKKO FM-2024 | 350~450°C (660~840°F) |
| HAKKO FM-2030 | 200~500°C (400~930°F) |
| HAKKO FM-2029 | 100~550°C (200~1030°F) |

● Change procedures (initial and when finished)

1. Press the operation button for the channel you want to change for approximately 1 second.

The display screen will switch to the setting selection screen shown below.

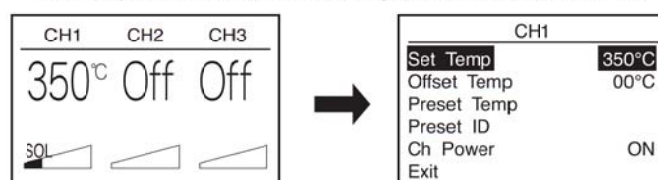

2. Select the item you want to change in the screen shown above and change it. When you want to finish the setting changes, select Exit and press the operating knob

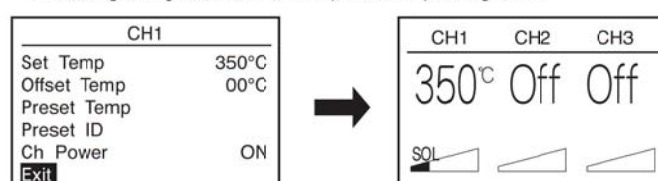

● Change setting temperature and offset temperature

1. Turn the operating knob, and for the setting temperature, select "Set Temp," for the offset temperature, select "Offset Temp," and press the operating knob to execute.

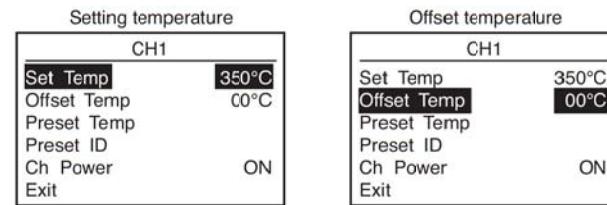

2. It will move to the respective temperature setting screen. Temperature settings are performed from the highest digit (for setting temperatures, the third digit, for offset temperatures, select + or -).

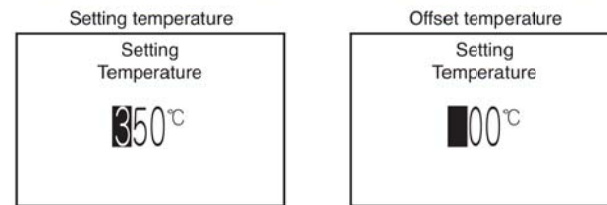

For the third digit of the offset temperature, select either + (blank) or -.

3. When changing the value of the selected cursor, turn the operating knob, and when moving the cursor itself, press the operating knob. (The figure below is the set temperature display.)

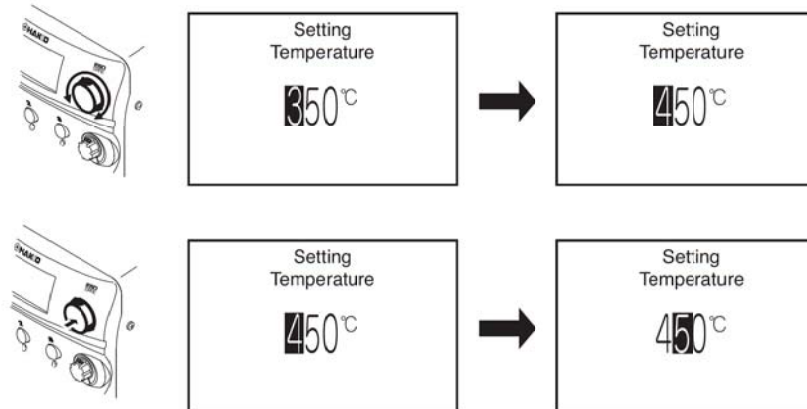

4. After the setting changes for the first digit are complete, it will return to the setting selection screen when the operating knob is pressed.

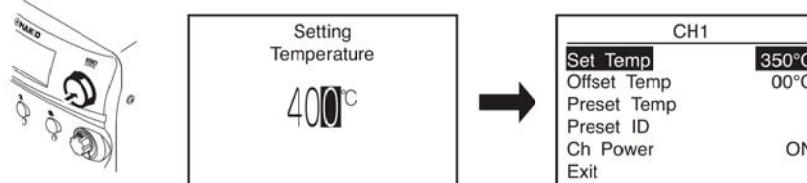

● Setting the preset temperature

1. Turn the operating knob, select "Preset Temp," and press the operating knob when you have made your choice.

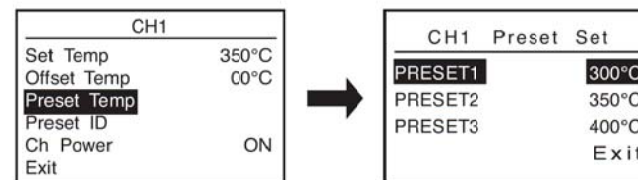

2. Turn the operating knob, and make your choice by selecting the desired preset temperature from the three options shown and pressing the operating knob.

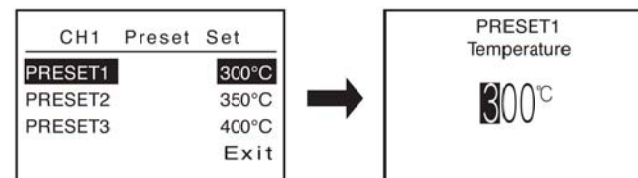

Regarding changing the numerical values, it can be performed using the same steps as changing the setting temperature.

● Changing the preset ID

1. When you select the preset ID and press the operating knob, it will move to a screen where you will change the names of each preset.

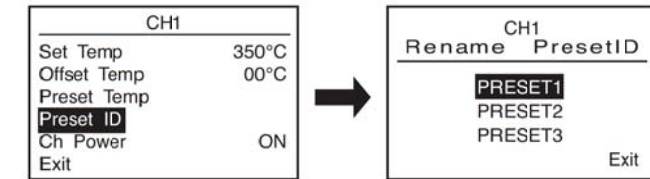

2. When you match the cursor with the name you want to change and press the operating knob, it will switch to the operating screen.

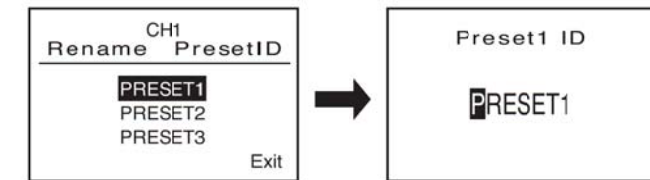

3. When you turn the operating knob, the character highlighted by the cursor will change, and when you press the operating knob, the cursor will move to the next character.

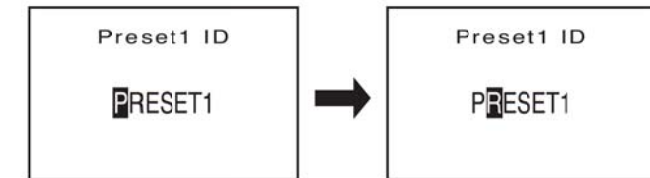
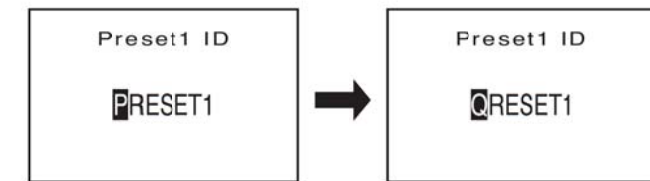

4. After you are finished changing the first character, it will return to the preset selection screen.

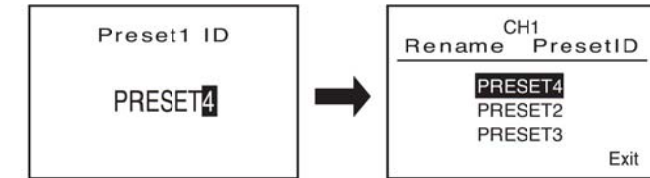

● Switching the ON/OFF output for each channel

1. Turn the operating knob so that the cursor is on "Ch Power" and press the operating knob.

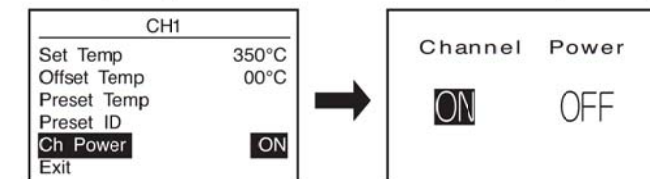

2. When you select either ON or OFF for the output and press the operating knob, it will return to the setting screen. At this time, if you set the power to OFF, the setting screen will be as shown below. This is because settings other than the channel output are no longer necessary.

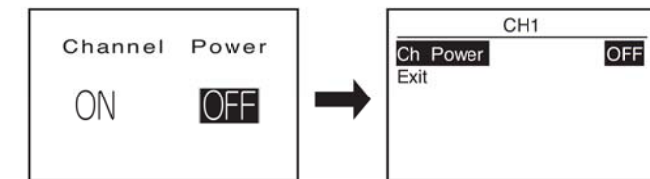

5. OPERATION

● Changing the settings for the Hot Air (HAKKO FM-2029)

The Hot Air can only be used in CH3. When you connect it, the screen will be as shown below.



The Hot Air has a manual mode and an auto mode, and the settings that can be changed are different.

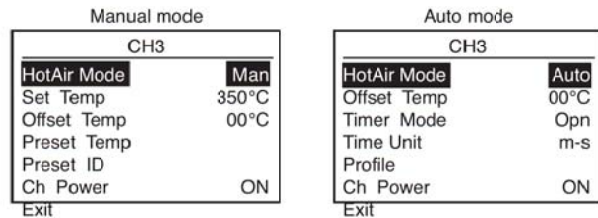

In either case, the screen is set to scroll since all of the items cannot fit on the screen. In manual mode, other than selecting Hot Air Mode, both the changing method and initial settings are the same as the other grips.

● Initial settings when in auto mode

| | Initial Value |
|--------------------------|--|
| Offset Temp | 0°C (0°F) |
| Timer Mode | Opened |
| Time Unit | min-sec |
| Profile (Temp) (Time) | 300/350/400°C (570/660/750°F) 30/30/30sec |
| Ch Power | ON |

The steps for the setting items with the same name are the same as the setting method for the other grips. The way to change the settings for items other than these is illustrated below.

● Changing Timer Mode

1. Turn the operating knob, select "Timer Mode," and press the operating knob when you have made your choice.

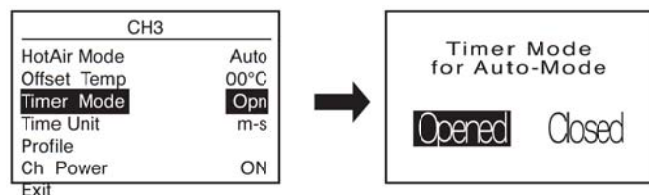

2. When you have selected the desired mode, press the operating knob.

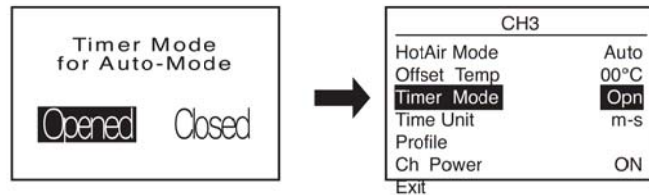

■ On the difference between Opened and Closed in "Timer Mode"

In Auto mode, the temperature profile listed below is already set. It is set to the time in which the temperature stabilizes when it is set to Opened, and it is set to both the time the temperature changes and the time the temperature stabilizes when it is set to Closed.

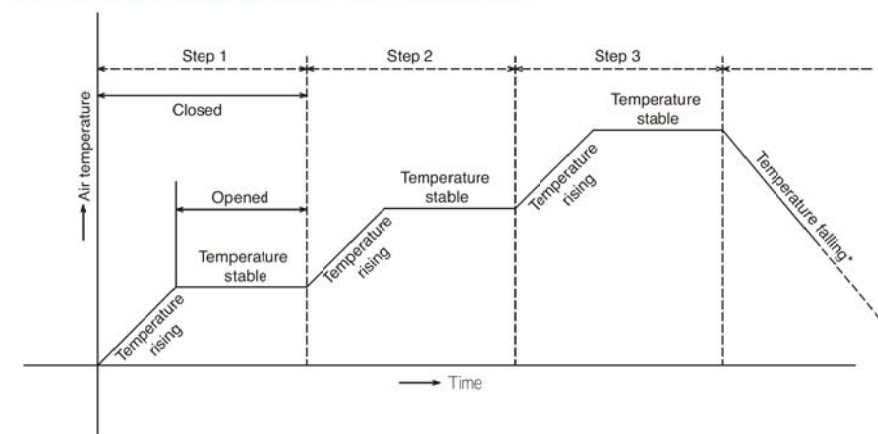

*In Auto mode, a 15 second cool-down will be performed after all steps are completed and the air will stop.

● Changing Time Unit

1. Turn the operating knob and select "Time Unit." Press the operating knob to execute.

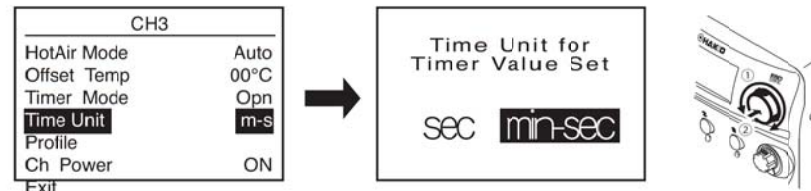

2. When you press the operating knob after making your selection, it will return to the setting selection screen.

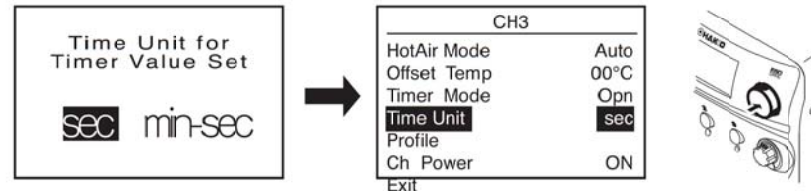

For the Time Unit, when you set the temperature profile, the set time for each step will be displayed as "sec" for seconds and "min-sec" for minutes and seconds.

● Changing the Profile

1. Turn the operating knob and select "Profile." When you press the operating knob, it will switch to the profile setting screen.

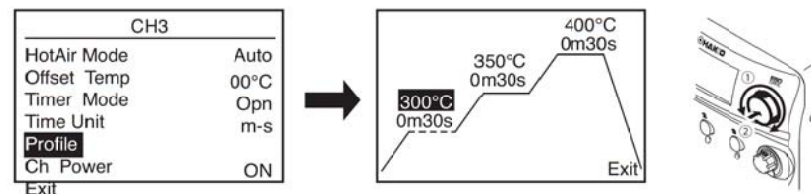

2. When you press the operating knob once in the profile setting screen, you can change the value of the section highlighted by the cursor.

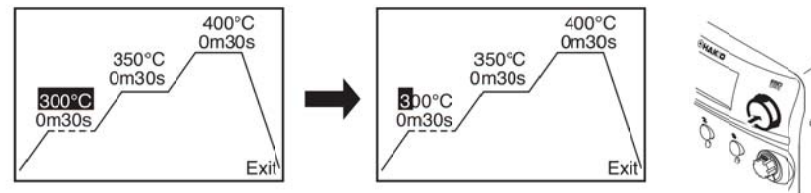

3. To change the value, turn the operating knob, and to change the digit, press the operating knob.

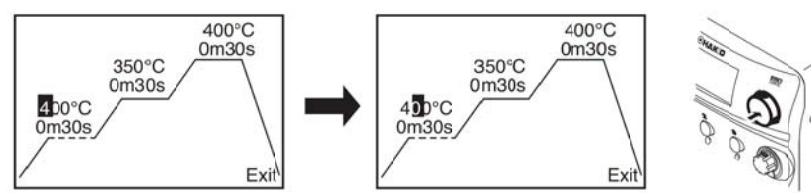
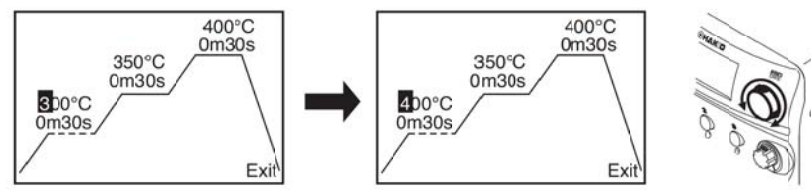

4. When you press operating knob after the settings to the first digit are complete, it will return to the original profile setting screen.

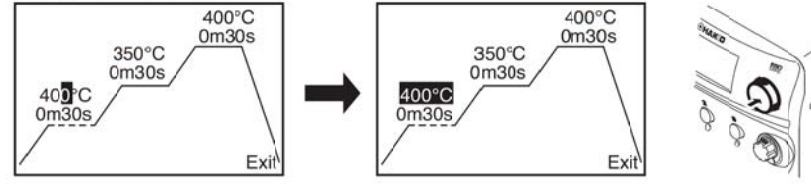

* When you wish to select a setting for a different step, turn the operating knob in this state.

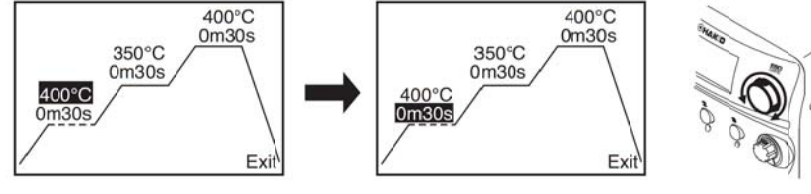

6. PARAMETER SETTINGS

■ Parameter settings

For parameters, there are two types: system parameters and channel parameters. System parameters are used for the settings for the entire system, and channel parameters are used for the settings for each channel.

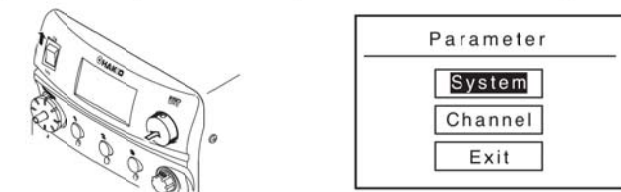

| System parameters | | |
|-------------------|------------------------------------|---------------|
| Parameter name | Value | Initial value |
| Temp Mode | °C / °F | °F |
| Auto-ShutOff | Off / 30min / 60min | Off |
| Vaccum Mode | Normal / Timer | Normal |
| Vaccum Time* | 1~5sec | 1sec |
| Password Lock | ON / Partial / OFF | OFF |
| Password** | 3 upper case alphabetic characters | none |
| Initial Reset | OK / Cancel | |

System setting screen

| System | |
|---------------|------|
| Temp Mode | °C |
| ShutOff Set | Off |
| Vaccum Mode | Time |
| Vaccum Time* | 1s |
| Password Lock | On |
| Password** | |
| InitialReset | |
| Exit | |

* "Vacuum Time" is displayed when "Timer" is selected in Vacuum Mode.

** "Password" is displayed when "ON" or "Partial" is selected for the Password Lock.

Channel parameters

| Parameter name | Value | Initial value |
|----------------|--|---------------|
| AutoSleep | OFF / 0 ~ 29min | 6min |
| Sleep Temp | 200 ~ 300°C every 20°C (390 ~ 570°F every 36°F) | 200°C (390°F) |
| Low Temp | 30 ~ 150°C (54 ~ 270°F) | 150°C (270°F) |
| Error Alarm | On / Off | On |
| Ready Alarm | On / Off | On |
| Pump Select* | Internal / External | Internal |
| Exit | | |

* "Pump Select" is displayed when hot air is connected with channel 3.

Explanation of each parameter and how to change the settings

● Temperature Mode

The displayed temperature can be switched between Centigrade and Fahrenheit. Turn the operating knob to switch it and press the operating knob when you have made your choice.

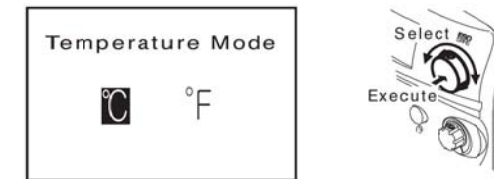

● Auto-ShutOff Setting

Select whether you will activate the auto shut off function. You can select from three options: OFF, 30 minutes or 60 minutes. Turn the operating knob when making your selection and press the operating knob when you have made your choice.



● Vacuum Mode Setting

Suction with the desoldering iron is performed either manually or in timer form. For mode selection, turn the operating knob and press the operating knob when you have made your choice.

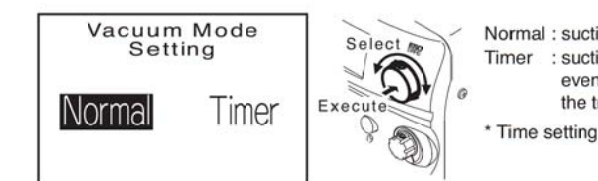

Normal : suction only when the trigger is pulled
Timer : suction performed for a designated time* even after you remove your hand from the trigger

* Time setting is performed in "Vacuum Time".

● Vacuum Time

This item is displayed when selecting "Timer" in Vacuum Mode. After suction, you can set the amount of time it will operate after you remove your hand from the trigger. When changing the numerical value, turn the operating knob; to execute, press the operating knob.



6. PARAMETER SETTINGS

● Password Lock Setting

When this function is activated, settings cannot be changed if the correct password is not entered. Selection choices are as follows.

- ON : Password entry required when changing all settings
- Partial : Password entry not required only when setting the offset, but required for everything else
- OFF : Password entry not required when changing all settings

Turn the operating knob and align the cursor with the desired item, then press the operating knob when you have made your choice. When the password lock is set to "ON" or "Partial," the item "Password" will be added to the parameter settings. Here, password changes can be performed.



A password is not included when it is shipped from the factory. Immediately after the password lock is activated, it will move to the password input screen.



Please refer to the "Password" section for how to enter your password.

After activating the password lock, you will be asked for your password before changing your settings in the manner shown below, so please change your settings after entering your password.

Example: When setting the Vacuum Mode

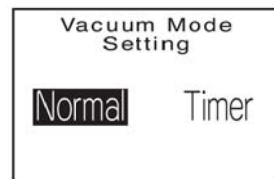
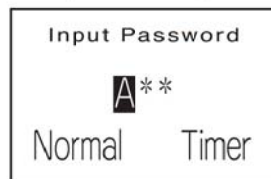

● Password

This is displayed when the password lock is activated, and you can enter and change your password. However, as stated above, entering your password is necessary before almost all setting changes. This is also true when you change your password, and at first the current password input screen will be displayed.

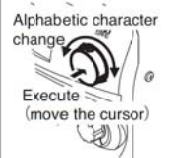
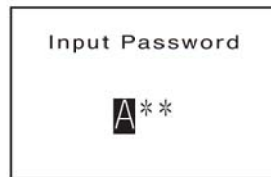

When changing the alphabetic characters, turn the operating knob, and when moving the cursor to the next character, press the operating knob.

When you enter the correct password, the monitor title will change from "Input Password" to "Set New Password". If it is still on "Input Password," the correct password was not entered. Check your password once more and then enter it.

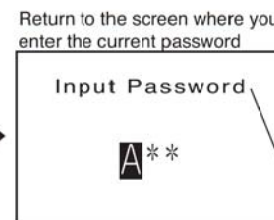
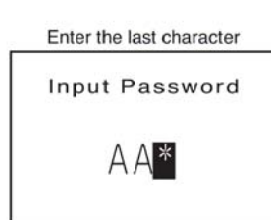

Input failure

Successfully entered



Here is how you know you are on the right page.

In the event you completely forgot your password and cannot change your settings, please consult the nearest retailer or dealer.

● Initial Reset

With initial reset, you can return the settings (except for the password) to what they were when it was shipped from the factory. The selection and execution methods are the same as the methods for the other settings.

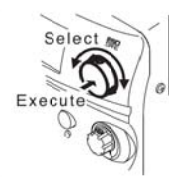
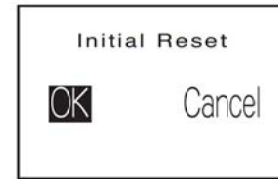

NOTE:
The password lock function and the password maintain the state before it initial resets it.

■ Explanations of each channel parameter and setting method

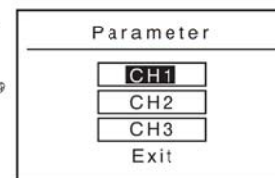
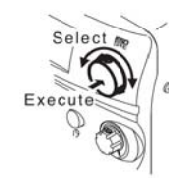

When the channel parameter is selected, the screen shown to the right will be displayed. When you select the channel you want to set here, it will switch to that channel's setting screen.

Turn the operating knob when you want to move the cursor, and press the operating knob when you have made your choice.

For the channel parameters, the displayed screen will differ when a grip other than Hot Air is inserted, when Hot Air is inserted, and when nothing is inserted.

| Grips other than Hot Air | Hot Air | Nothing inserted | | | | | | | | | | | | | | | | | | | | | | | | | | | | | | | | |
|---|---------|------------------|------------|-----|------------|-------|----------|-------|-------------|----|-------------|----|------|--|--|-----|--|-------------|----|-------------|----|-------------|-----|------|--|--|-----|--|-------------|----|-------------|----|------|--|
| <table border="1"> <tr><td>CH1</td><td></td></tr> <tr><td>Auto Sleep</td><td>06m</td></tr> <tr><td>Sleep Temp</td><td>200°C</td></tr> <tr><td>Low Temp</td><td>150°C</td></tr> <tr><td>Error Alarm</td><td>ON</td></tr> <tr><td>Ready Alarm</td><td>ON</td></tr> <tr><td>Exit</td><td></td></tr> </table> | CH1 | | Auto Sleep | 06m | Sleep Temp | 200°C | Low Temp | 150°C | Error Alarm | ON | Ready Alarm | ON | Exit | | <table border="1"> <tr><td>CH3</td><td></td></tr> <tr><td>Error Alarm</td><td>ON</td></tr> <tr><td>Ready Alarm</td><td>ON</td></tr> <tr><td>Pump Select</td><td>Int</td></tr> <tr><td>Exit</td><td></td></tr> </table> | CH3 | | Error Alarm | ON | Ready Alarm | ON | Pump Select | Int | Exit | | <table border="1"> <tr><td>CH1</td><td></td></tr> <tr><td>Error Alarm</td><td>ON</td></tr> <tr><td>Ready Alarm</td><td>ON</td></tr> <tr><td>Exit</td><td></td></tr> </table> | CH1 | | Error Alarm | ON | Ready Alarm | ON | Exit | |
| CH1 | | | | | | | | | | | | | | | | | | | | | | | | | | | | | | | | | | |
| Auto Sleep | 06m | | | | | | | | | | | | | | | | | | | | | | | | | | | | | | | | | |
| Sleep Temp | 200°C | | | | | | | | | | | | | | | | | | | | | | | | | | | | | | | | | |
| Low Temp | 150°C | | | | | | | | | | | | | | | | | | | | | | | | | | | | | | | | | |
| Error Alarm | ON | | | | | | | | | | | | | | | | | | | | | | | | | | | | | | | | | |
| Ready Alarm | ON | | | | | | | | | | | | | | | | | | | | | | | | | | | | | | | | | |
| Exit | | | | | | | | | | | | | | | | | | | | | | | | | | | | | | | | | | |
| CH3 | | | | | | | | | | | | | | | | | | | | | | | | | | | | | | | | | | |
| Error Alarm | ON | | | | | | | | | | | | | | | | | | | | | | | | | | | | | | | | | |
| Ready Alarm | ON | | | | | | | | | | | | | | | | | | | | | | | | | | | | | | | | | |
| Pump Select | Int | | | | | | | | | | | | | | | | | | | | | | | | | | | | | | | | | |
| Exit | | | | | | | | | | | | | | | | | | | | | | | | | | | | | | | | | | |
| CH1 | | | | | | | | | | | | | | | | | | | | | | | | | | | | | | | | | | |
| Error Alarm | ON | | | | | | | | | | | | | | | | | | | | | | | | | | | | | | | | | |
| Ready Alarm | ON | | | | | | | | | | | | | | | | | | | | | | | | | | | | | | | | | |
| Exit | | | | | | | | | | | | | | | | | | | | | | | | | | | | | | | | | | |

The reason the display screen is different is because the necessary setting items differ according to the connected grip. Below, the setting method for each item is illustrated.

● Auto Sleep

Select whether you want to activate the soldering iron's sleep function. When activated, the sleep function will turn on when it has been placed on the ironing rest for a set period of time and the temperature of the iron tip will drop* to a set temperature.



Select "Off"

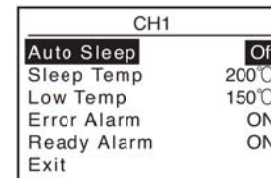

Select "On"



When changing your selection or changing the numerical value, turn the operating knob and press the operating knob when you have made your choice.

As for the time setting, when the first digit is completed, it will return to the initial screen like when it is "Off".

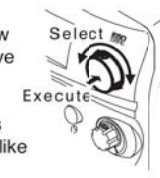

* The temperature when it is lowered is set as "Sleep Temp".

● Sleep Temperature

This sets the temperature when it is sleeping. The setting for the sleep temperature is not entered one digit at a time, the displayed temperature changes in 20 degree increments by turning the operating knob. When the desired temperature is displayed, you can set it by pressing the operating knob.

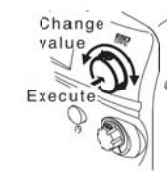
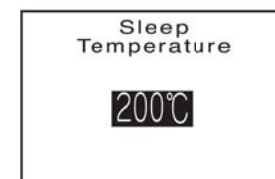

● Low Temp Alert Setting

Set the lower-limit error temperature. When this function is activated, if the sensor temperature goes below the lower-limit temperature, an error will be displayed and the warning buzzer will sound. Change the value by turning the operating knob, move the cursor and execute by pressing the operating knob.

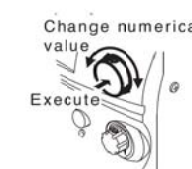
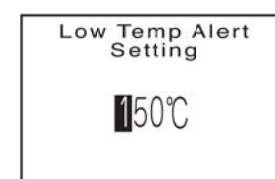

● Error Alarm Setting

You can set whether the buzzer will sound or not when an error occurs. Turn the operating knob and select ON or OFF, and press the operating knob to execute.

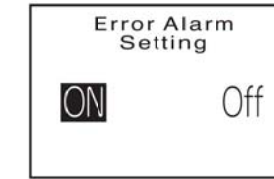

● Ready Alarm Setting

You can set whether the buzzer will sound or not when the iron tip, etc. has reached the set temperature and is ready for use. Turn the operating knob and select ON or OFF, and press the operating knob to execute.

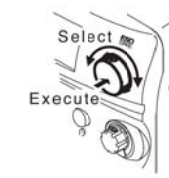
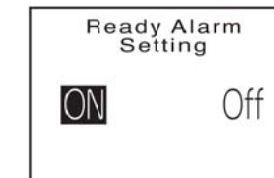

● Pump Select for Hot-Air (HAKKO FM-2029 only)

For the air for the HAKKO FM-2029, select whether you will use the station's internal pump or external air.

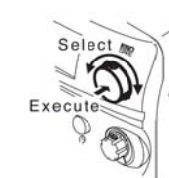

7. MAINTENANCE

Performing proper and periodical maintenance extends the product life. Efficient soldering depends upon the temperature, the quality and quantity of the solder and flux. Apply the following service procedure as dictated by the conditions of the usage.

⚠ WARNING

Since the handpiece tip/nozzle can reach a very high temperature, please work carefully. Except the case especially indicated, always turn the power switch OFF and disconnect the power plug before performing any maintenance procedure.

1 Temperature

High temperatures shorten tip life and may cause thermal shock to components. Always use the lowest possible temperature. The excellent thermal recovery characteristics of the HAKKO FM-206 ensure effective soldering at low temperatures.

2. Cleaning

Always clean the tip/nozzle before use to remove any residual solder or flux adhering to it. Use the tip cleaner or cleaning sponge. Contaminants on the tip have many deleterious effects, including reduced heat conductivity, which contribute to poor performance.

3. After use

Always clean the tip/nozzle and coat it with fresh solder after use. This guards against oxidation.

This procedure, if followed daily, will materially add to tip life.

- Set the temperature to 250°C (482°F).
- When the temperature stabilizes, clean the tip and check the condition of the tip. If the tip is badly worn or deformed, replace it.
- If the solder plated part of the tip is covered with black oxide, apply fresh solder, containing flux, and clean the tip again. Repeat until all the oxide is removed, then coat the tip with fresh solder.
- Turn the power OFF and remove the tip, using the heat resistant pad. Set the tip aside to cool.
- Remaining oxides, such as the yellow discoloration on the tip shaft, are not harmful but can be removed with isopropyl alcohol.

4. When the unit is not being used and the auto power shutoff is not active.

Never allow the unit to idle at a high temperature for extended periods. This will allow the tip to become oxidized. Turn the power switch OFF. If it is to be out of service for several hours, it is advisable to pull the power plug as well.

■ Maintenance of the electromagnetic valve and pump head

● Remove the cover

When performing maintenance on either the electromagnetic valve or the pump head, remove the screws holding the cover and take the cover off.

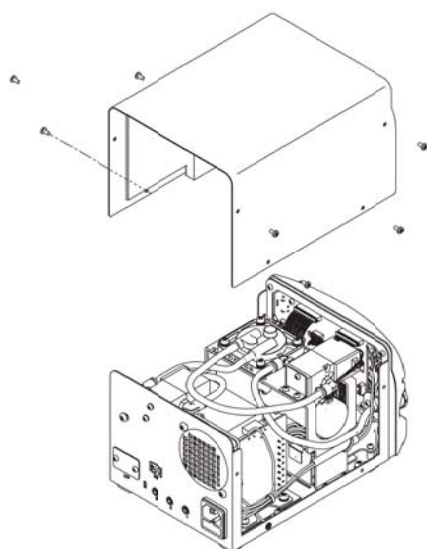

● Electromagnetic valve maintenance

- Remove the screws holding the electromagnetic valve in place.

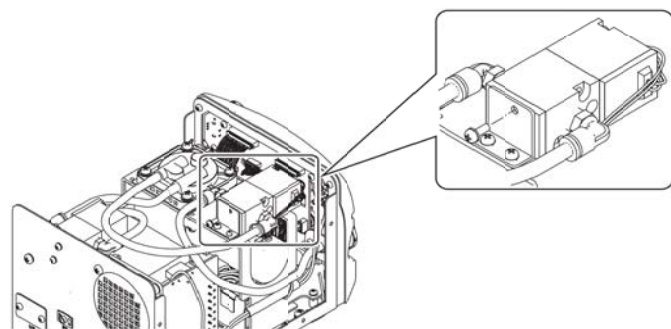

- Remove the bottom of the electromagnetic valve.

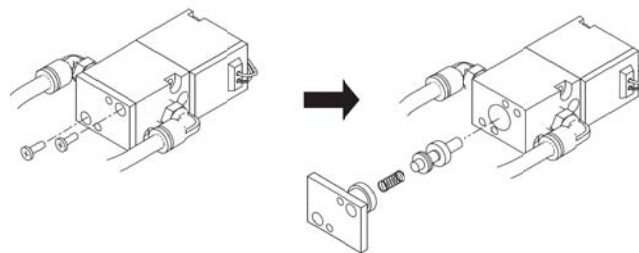

- Clean the parts that have flux attached to them, such as the inside of the electromagnetic valve, with alcohol.

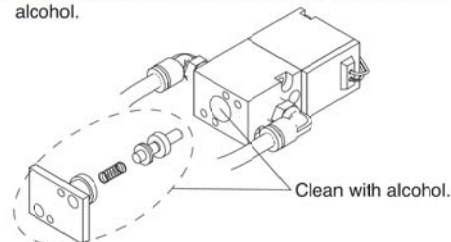

⚠ Caution
Do not use thinner when cleaning.

- Assembly is done in the opposite order of disassembly.

*There is one more electromagnetic valve. Remove the screws on the back of the chassis, and from that point on remove and clean following the same steps.

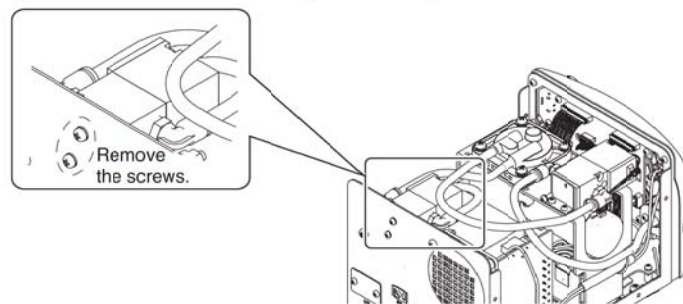

● Cleaning the pump head

- Remove the valve and valve guard and remove any attached flux.

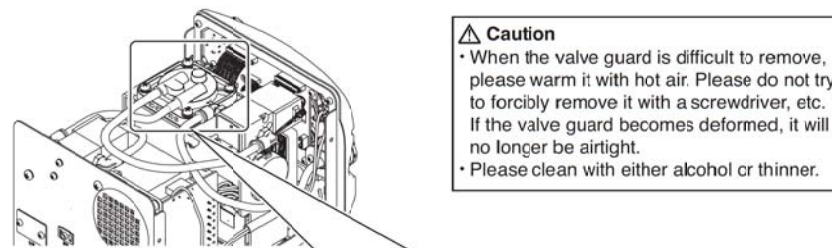

⚠ Caution
• When the valve guard is difficult to remove, please warm it with hot air. Please do not try to forcibly remove it with a screwdriver, etc. If the valve guard becomes deformed, it will no longer be airtight.
• Please clean with either alcohol or thinner.

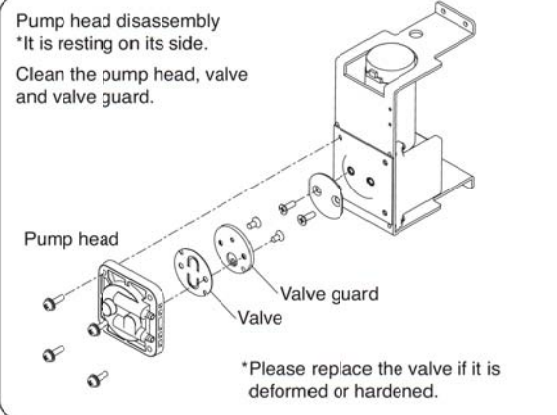

- Install the valve and valve guard.

⚠ Caution
When assembling the pump, please make sure to keep it airtight so that there are no air leaks.

8. CHECKING PROCEDURE

⚠ WARNING

Unless otherwise directed, carry out these procedures with the power switch OFF and the power UNPLUGGED.

■ Check for a broken heater or sensor

- Check for a broken heater or sensor

Measure the resistance across this position.

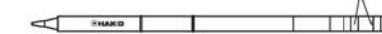

Verify the electrical integrity of the heater and sensor. Measure the resistance of the heater and sensor while at room temperature (15~25°C : 59~77°F). It should be 8 ±10%. If the resistance exceeds these limits, replace the tip.

■ Check the grounding line

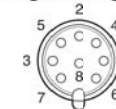

■ Checking the connection cord for breakage (HAKKO FM-2027)

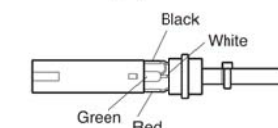

- Unplug the connection cord from the station.
- Measure the resistance value between Pin 2 and the tip.
- If the value exceeds 2 (at room temperature), perform the tip maintenance described on section 2, maintenance for the tip. If the value still does not decrease, check the connection cord for breakage.

- Remove the soldering tip and the sleeve assembly.
- Turn the front piece of the HAKKO FM-2027 counterclockwise and remove the cover.
- Measure the resistance values between the connector and the lead wires at the socket as follows:

Pin 1 – Red Pin 2 – Green
Pin 3 – Black Pin 5 – White

If any value exceeds 0 or is ∞, replace the HAKKO FM-2027.

■ Replacing the fuse

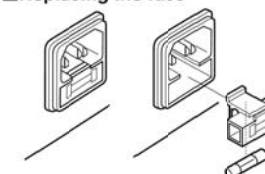

- Unplug the power cord from the power receptacle.
- Remove the fuse holder.
- Replace the fuse.
- Put the fuse holder back in place.

9. TROUBLE SHOOTING GUIDE

⚠ WARNING

Before checking the inside of the HAKKO FM-206 or replacing parts, be sure to disconnect the power plug. Failure to do so may result in electric shock.

- The unit does not operate when the power switch is turned on.
CHECK : Is the power cord and/or the connection plug disconnected?
ACTION : Connect it.
- The tip does not heat up. "Sens Error" is displayed.
CHECK : Is the fuse blown?
ACTION : Replace the fuse. If the fuse blows again, send the unit in for repair.
- Solder does not wet the tip.
CHECK : Is the tip inserted properly?
ACTION : Insert the tip completely.
CHECK : Is the connection cord and/or the heater/sensor broken?
ACTION : If the cord assembly is broken, replace the soldering iron, desoldering tool or handpiece.
- The tip temperature is too high.
CHECK : Is the tip temperature too high?
ACTION : Set the appropriate temperature.
- The tip temperature is too low.
CHECK : Is the tip contaminated with oxide?
ACTION : Remove the oxide.
- "Grip Error" is displayed.
CHECK : Is the other handpiece connected?
ACTION : Remove and reinsert the handpiece.
- The low-temperature alarm tolerance error "Low Temp" is displayed.
CHECK : Is the tip too small for the items to be soldered?
ACTION : Use a tip with a larger thermal capacity.
CHECK : Is the setting value for the low-temperature alarm tolerance too low?
ACTION : Increase the setting value.
- Heater terminal short circuit error "Heater Short Error" is displayed.
CHECK : Is the appropriate HAKKO tip/nozzle being used?
ACTION : Turn the power switch OFF and insert the genuine HAKKO tip/nozzle. Turn the power switch ON.
- "Heat up Error" is displayed. (for MODEL FM-2023)
ACTION : Turn the power switch OFF and insert the genuine HAKKO tip. Turn the power switch ON.
- "Drive Error" is displayed. (for MODEL FM-2023)
CHECK : Is the tip left on the wet cleaning sponge?
ACTION : Turn the power switch off. Turn the power switch on again after removing the tip from the wet cleaning sponge.
- "Zero-Cross Error" or "System Error" is displayed.
ACTION : Turn off the power switch. Turn on the power switch again. If the "Zero-Cross Error" / "System Error" continues to be displayed after turning on the power switch, contact your HAKKO representative.

10. ERROR MESSAGE

● Sens Error

When there is the possibility that a failure has occurred in the sensor or heater (including the sensor circuit), "Sens Error" is displayed and the power is shut down.

● Grip Error

"Grip Error" will be displayed if the connector cord is not attached to the station OR the wrong soldering iron is connected.

● Low Temp

If the sensor temperature falls below the difference between the current temperature setting and the low-temperature alarm tolerance, "Low Temp" is displayed and the warning buzzer sounds. When the tip temperature rises to a value within the set tolerance, the buzzer will stop sounding.

EXAMPLE:

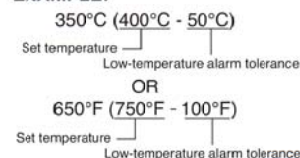

EXAMPLE:

Assume that the temperature setting is 400°C/750°F and the tolerance 50°C/100°F. If the temperature continues to decrease and finally falls below the value indicated below while the heating element is on, the displayed value starts blinking to indicate that the tip temperature has dropped.

● Heater Short Error

"Heater Short Error" will flash, and the buzzer will sound continuously, when the tip is inserted incorrectly, an incompatible tip is inserted, or a foreign object has found its way into the connector.

● Heat up Error (For MODEL FM-2023)

This is displayed in cases such as when the iron tip abnormally heats up relative to the set temperature when the micro-tweezers (MODEL FM-2023) are connected.

● Drive Error (For MODEL FM-2023)

This is displayed in cases such as when judged that an excessive pulse has been generated when the micro-tweezers (MODEL FM-2023) are connected.

● TRig Error

A "trig error" will occur if the trigger is pulled before the nozzle temperature has reached the set temperature. Please wait until the temperature reaches the set temperature and stabilizes.

● Zero-Cross Error

This is displayed when a zero-cross cannot be measured in the designated cycle. Should this error be displayed, please consult the nearest retailer or dealer.

● System Error

This is displayed when the system is unable to operate normally. Should this error be displayed, please consult the nearest retailer or dealer.

● Det Error

"Det Error" appears on the display when turning the power on after connecting the MODEL FM-2022/2023 with a hot tip. This is not an error. Wait for approximately 10 seconds until the model functions properly.

11. OPTION

● External switch (MODEL FM-2024)

An optional foot switch are available which can be connected to the unit to START/STOP preheating.

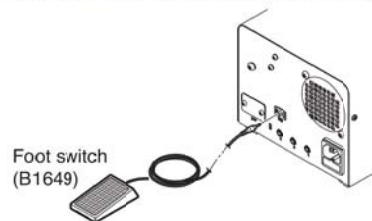

● Security lock

The HAKKO FM-206 comes with an anti-theft security slot.

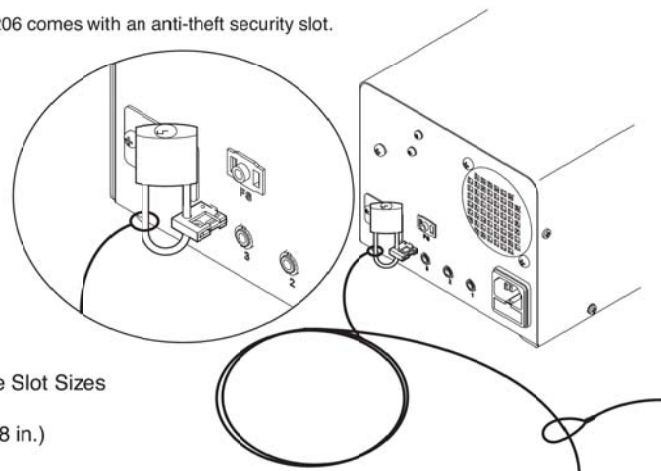

12. PARTS LIST

Pump assembly

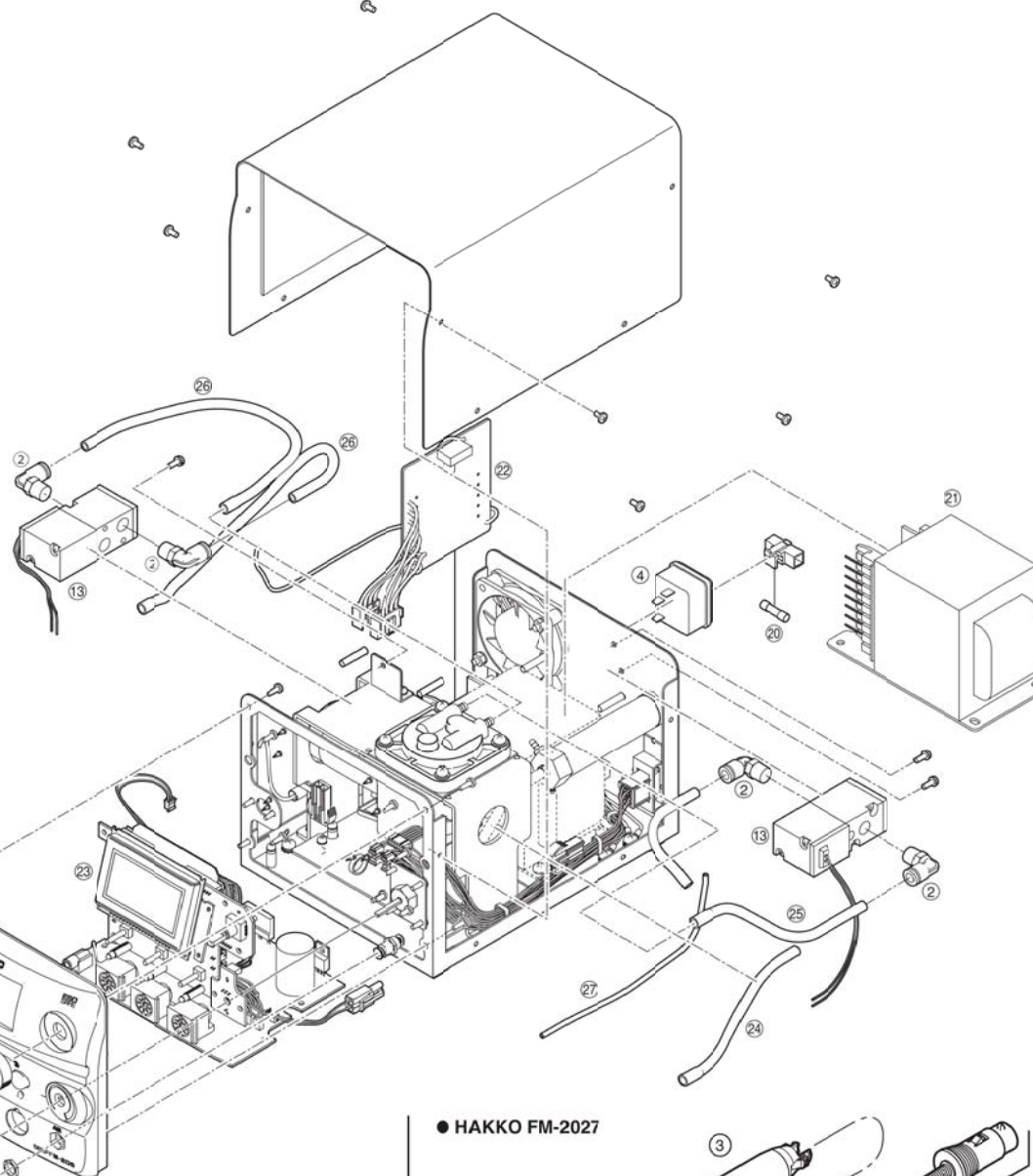
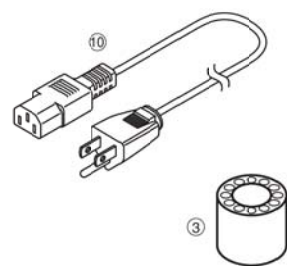
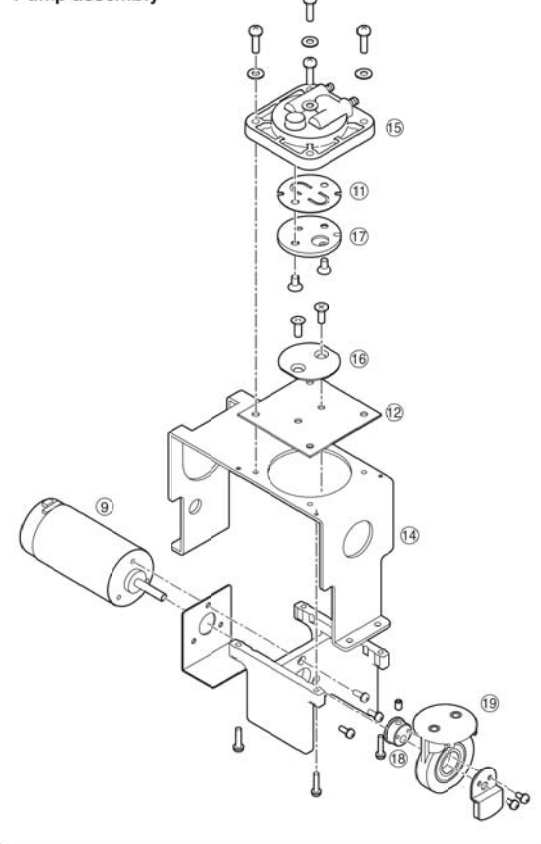

● HAKKO FM-2027

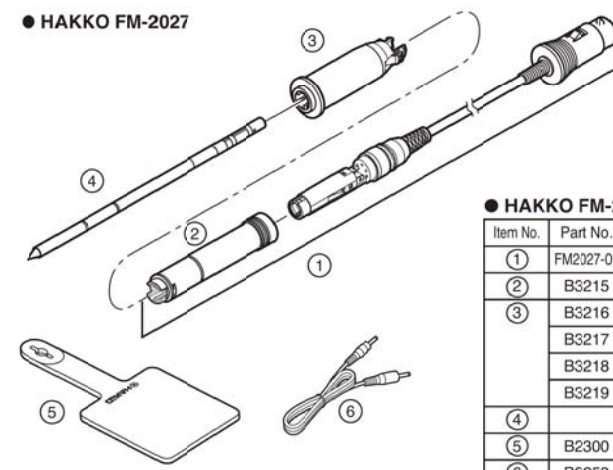

● HAKKO FM-2027

| Item No. | Part No. | Part Name | Specifications |
|----------|-----------|--------------------|----------------|
| ① | FM2027-02 | Connector Assembly | 24V-70W |
| ② | B3215 | Connector Cover | |
| ③ | B3216 | Sleeve Assembly | Yellow |
| | B3217 | Sleeve Assembly | Orange |
| | B3218 | Sleeve Assembly | Blue |
| | B3219 | Sleeve Assembly | Green |
| ④ | | Tip | |
| ⑤ | B2300 | Heat Resistant Pad | |
| ⑥ | B3253 | Connecting Cable | |

● Iron Holder

| Item No. | Part No. | Part Name | Specifications |
|----------|----------|-------------|----------------|
| ①-⑨ | FH200-01 | Iron holder | |

● Iron Holder Parts

| Item No. | Part No. | Part Name | Specifications |
|----------|----------|----------------------------|------------------|
| ① | B3001 | Iron receptacle | With screws |
| ② | B2791 | Tip fixing spring | |
| ③ | B3248 | Holder for iron receptacle | |
| ④ | B3251 | Iron holder base | With rubber feet |
| ⑤ | B3249 | Cleaner base | With rubber feet |
| ⑥ | B3250 | Stay | |
| ⑦ | B3252 | Switch case assembly | |
| ⑧ | 599B-02 | Tip cleaner | |
| ⑨ | 599-029 | Cleaning wire | |

● HAKKO FM-206

| Item No. | Part No. | Part Name | Specifications |
|----------|----------|--|----------------|
| ① | A1514 | Ceramic paper filter | 10 pcs. |
| ② | B1075 | Elbowunion | |
| ③ | B2756 | Tip tray | |
| ④ | B2384 | Inlet | |
| ⑤ | B2852 | Switch | With O-ring |
| ⑥ | B2880 | Vacuum outlet cap | |
| ⑦ | B2954 | O-ring | |
| ⑧ | B3439 | Vacuum outlet retainer | |
| ⑨ | B3428 | Motor | |
| ⑩ | B2419 | Power cord, 3 wired cord & american plug | |

| Item No. | Part No. | Part Name | Specifications |
|----------|----------|--------------------------------|----------------|
| ⑪ | A1583 | Valve plate | |
| ⑫ | A1584 | Diaphragm | |
| ⑬ | B3667 | Solenoid valve | |
| ⑭ | B3668 | Pump frame | |
| ⑮ | B3669 | Pump head | |
| ⑯ | B3670 | Diaphragm setting plate | |
| ⑰ | B3671 | Fixing plate | |
| ⑱ | B3672 | Crank shaft | |
| ⑲ | B3673 | Crank | |
| ⑳ | B3674 | Fuse/250V-7A | |
| ㉑ | B3676 | Transformer/100-120V | |
| ㉒ | B3678 | P.W.B./Transformer | |
| ㉓ | B3679 | P.W.B./Temp. Control & display | |
| ㉔ | B3681 | Inner hose | 6MM × 100L |
| ㉕ | B3682 | Inner hose | 6MM × 115L |
| ㉖ | B3683 | Inner hose | 6MM × 220L |
| ㉗ | B3684 | Inner hose | 3MM × 170L |