

DA7210/11 USER MANUAL



September 2012

User manual for the set-up and operation of the DA7210/11 evaluation board and control software

DA7210/11 USER MANUAL

Contents

Contents	1
1 Introduction	2
2 Hardware	2
2.1 Power Supplies	5
2.2 Jumpers and Link Positions	6
3 Evaluation Board Features	13
3.1 USB Interface	13
4 Control Software	13
4.1 Installation	13
4.2 Set-up Files	16
4.2.1 Text File	16
4.2.2 Spreadsheet File	17
4.3 Control Panels	19
4.3.1 Front Panel	19
4.3.2 Register Map Page 0	20
4.3.3 Register Map Page 1	21
4.3.4 GP Filters Register Map	22
4.3.5 Volume Control Panel	23
5 RT Filters GUI	24
5.1 Software Installation	24
5.2 Control Panels	26
5.2.1 Running the Interface and USB Initialisation	26
5.3 Filter Setup Panel	28
5.4 Coefficients Tab	29
5.5 Five-band Equaliser and Voice Filter Panel	31

DA7210/11 USER MANUAL

1 Introduction

The DA7210/11 evaluation board has been produced to allow measurement, evaluation and programming of the DA7210/11 ultra-low power audio codec evaluation board and control software. The evaluation PCB is supplied together with a DVD ROM containing documentation and driver files.

The driver software uses a simple graphical user interface (GUI), allowing the DA7210/11 device to be controlled via a USB port of a PC. An additional GUI is available to control the highly configurable filter paths within the DA7210/11; including general purpose, five-band equaliser and high pass filters

The board has a number of jumper links to allow configuration of the board and to provide measurement test points.

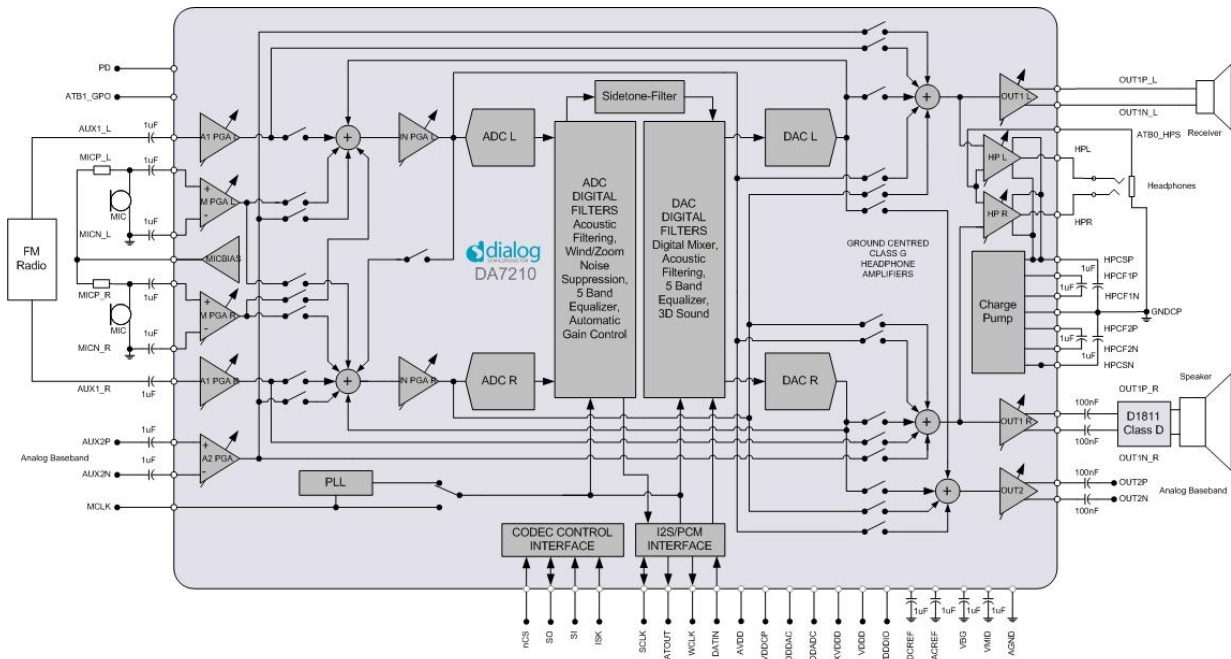

Figure 1 DA7210/11 Block Diagram

The accompanying software requires a PC operating Windows 2000/XP with a USB1.1 or USB2 interface. The software will run under Vista if the default installation location is changed to 'C:\Dialog Semiconductor\'

The DA7210/11 device plus the USB Interface consume approximately 5mA in the standby state. The evaluation board and software are not guaranteed to operate in a USB hub. See the section on Power Supplies below.

The control software permits configuration of the device using either pre-prepared templates or individual write and read operations to all control registers

2 Hardware

There are three options available when using the DA7210/11 evaluation mainboard, Figure 2:

1. A miniboard containing the DA7210 in a CSP 49-pin package connected to evaluation board 44-179-93-02-C via jumpers J28, J30, J36 and J38, Figure 3. This board can also be used standalone or in conjunction with a customer development system.

DA7210/11 USER MANUAL

2. A miniboard containing the DA7211-00 in a 36-pin CSP package connected to evaluation board 44-179-93-02-B via jumpers J28, J30, J36 and J38, Figure 4. This board can also be used standalone or in conjunction with a customer development system.
3. A miniboard containing the DA7211-01 in a 36-pin CSP package connected to evaluation board 44-179-93-02-E via jumpers J28, J30, J36 and J38,. This board can also be used standalone or in conjunction with a customer development system.

A USB-I2C bridge is used for communication with the device, and there are number of external active components to reduce the requirement for external equipment.

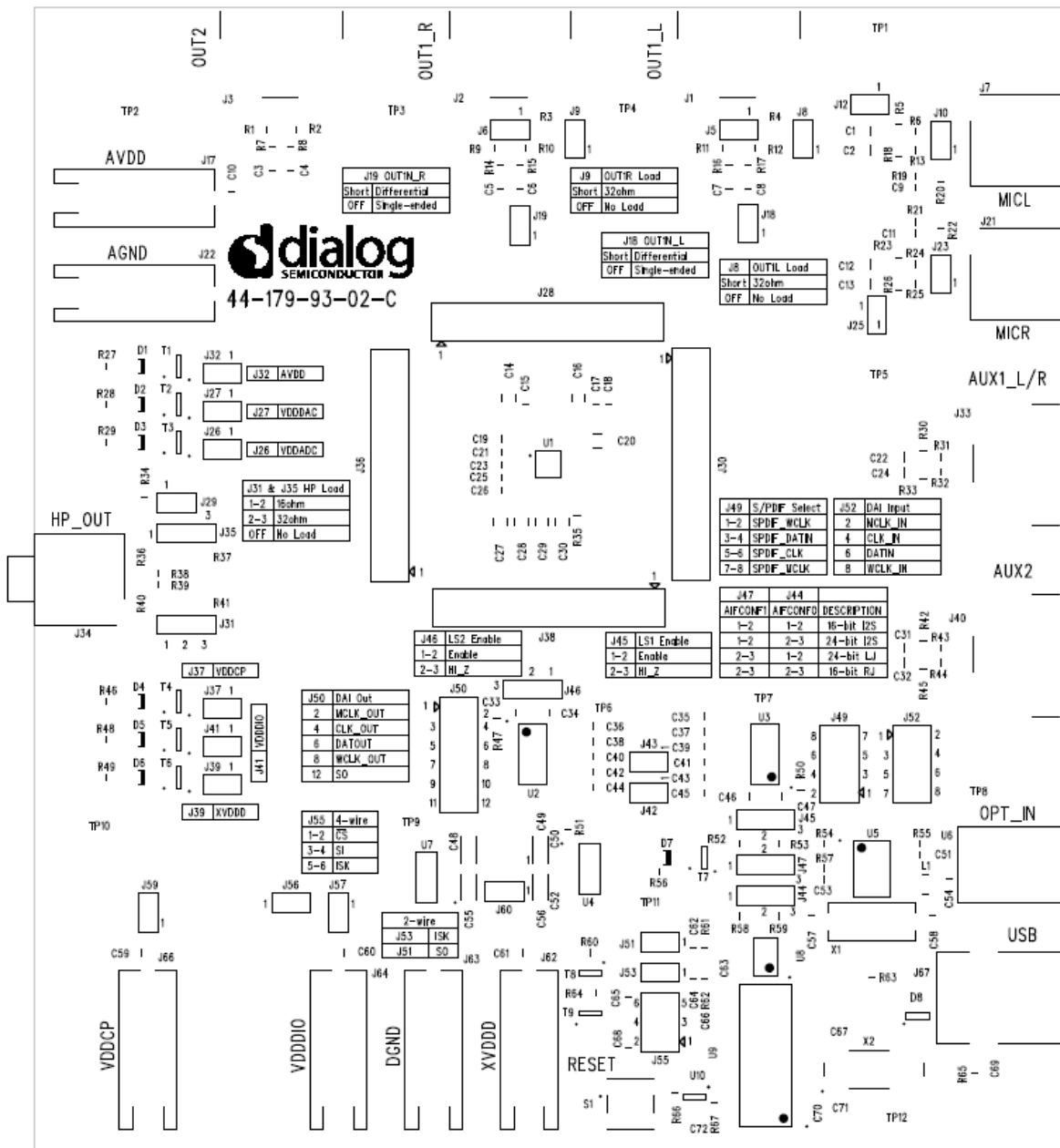

Figure 2 Evaluation Board 44-179-93-02-C Mainboard

DA7210/11 USER MANUAL

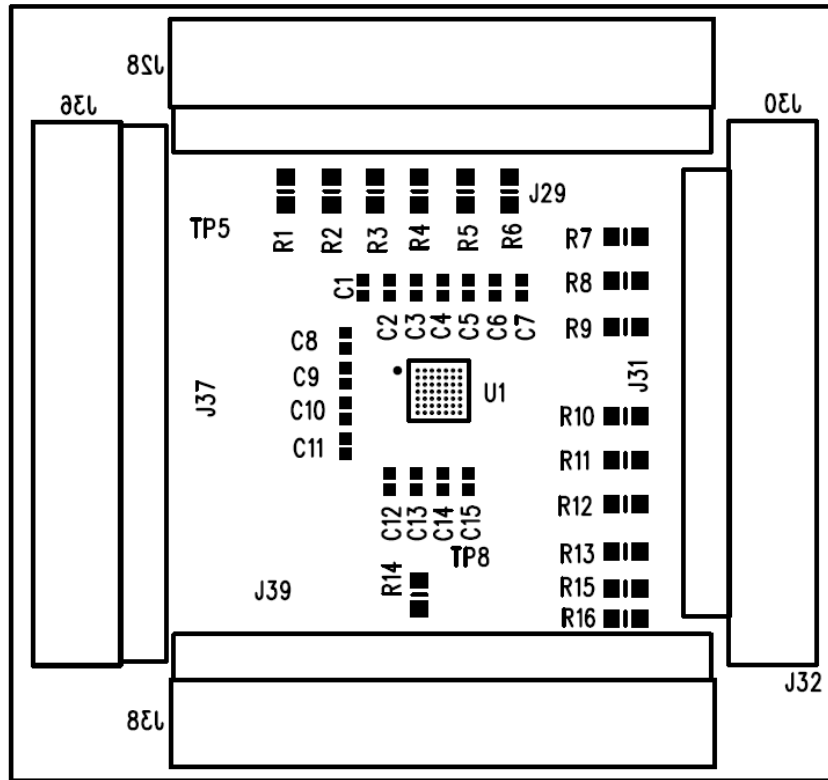

Figure 3 DA7210 44-179-93-04-C Miniboard

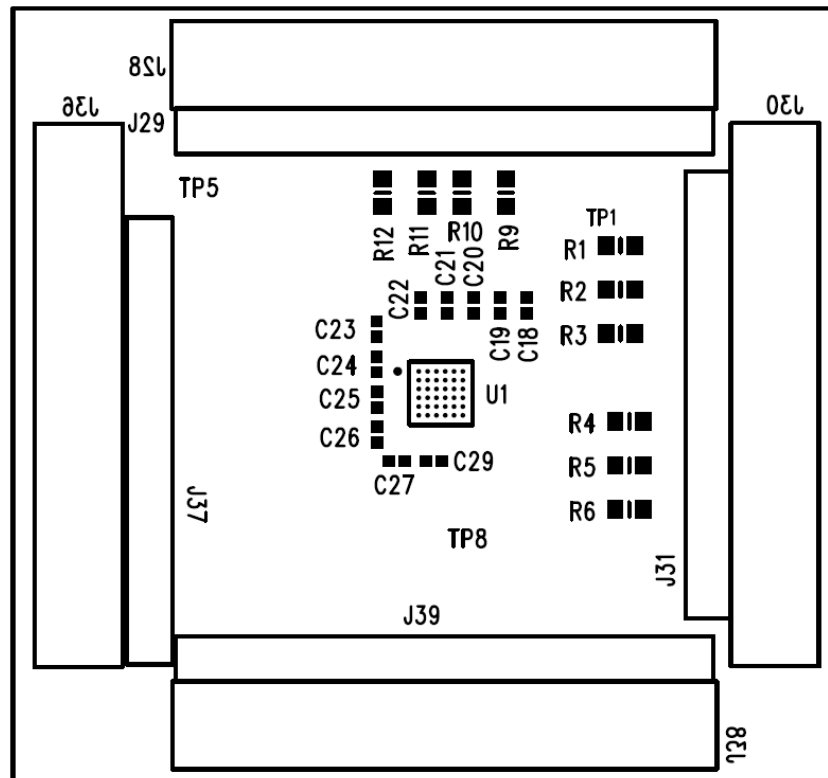

Figure 4 DA7211-00 44-179-93-04-B Miniboard

DA7210/11 USER MANUAL

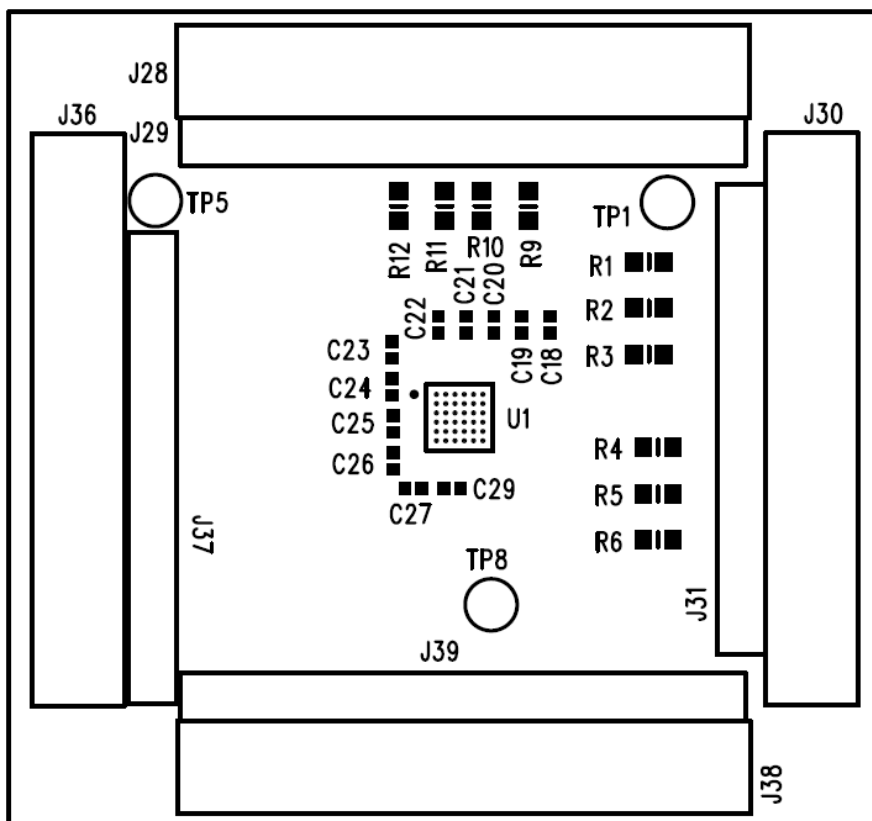

Figure 5 DA7211-01 44-179-93-04-E Miniboard

The passive components needed for noise decoupling or charge pump operation have been placed as close as possible to the DUT pins to ensure optimum operational performance.

Gerber data for the board is available on request.

2.1 Power Supplies

The board is intended to be supplied by power supplies in the range $+1.8V_{dc}$ to $+2.5V_{dc}$ (nominal). The power supplies are connected via 4mm sockets: AVDD, VDDCP, VDDDAC, VDDADC, VDDDIO, DGND and AGND. LEDs D1 to D6 will illuminate when the power supplies are correctly connected.

Some devices on the board will be powered from the $+5V_{dc}$ or $+3.3V_{dc}$ supply produced by the USB interface module.

For demonstration purposes the $+5V_{dc}$ USB supply can be connected to regulator, U9, to produce $+1.8V_{dc}$ capable of supplying all of the DUT the power supply pins. This configuration allows complete DUT operation using just USB and TOSLINK connections only, but maximum headphone power output will be limited when using $+1.8V$ VDDDCP power supply.

DA7210/11 USER MANUAL

2.2 Jumpers and Link Positions

Header	Link Position	Function	Notes	
J5		OUT1_L speaker connection	External connection	
J6		OUT1_R speaker connection	External connection	
J8	On	OUT1_L 32Ω load selected		
	Off	OUT1_L no load		
J9	On	OUT1_R 32Ω load selected		
	Off	OUT1_R no load		
J10		MIC_L differential connection		External connection
J12	On	MICN_L single-ended input		
	Off	MICN_L differential input		
J18	On	OUT1N_L differential output		
	Off	OUT1N_L single-ended output		
J19	On	OUT1N_R differential output		
	Off	OUT1N_R single-ended output		
J23		MIC_R differential connection	External connection	
J25	On	MIC_R single-ended input		
	Off	MIC_R differential input		
J26	Short link	Short VDDADC current measurement point	N/A for DA7211	
	DMM link	VDDADC current measurement point		
J27	Short link	Short VDDDAC current measurement point	N/A for DA7211	
	DMM link	VDDDAC current measurement point		
J29	On	Headphone sense ground connected	Should be disconnected for DA7211	
	Off	Headphone sense ground disconnected		
J31	1-2	HPL 16Ω load selected		
	2-3	HPL 32Ω load selected		
J32	Short link	Short AVDD current measurement point		

DA7210/11 USER MANUAL

	DMM link	AVDD current measurement point	
J35	1-2	HPR 16Ω load selected	
	2-3	HPR 32Ω load selected	
J37	Short link	Short VDDCP current measurement point	
	DMM link	VDDCP current measurement point	
J39	Short link	Short XVDDD current measurement point	N/A for DA7211
	DMM link	XVDDD current measurement point	
J41	Short link	Short VDDDIO current measurement point	N/A for DA7211
	DMM	VDDDIO current measurement point	
J42	On	WCLK slave mode	
	Off	WCLK master mode	
J43	On	CLK slave mode	
	Off	CLK master mode	
J44 / J47	1-2 / 1-2	16-bit I2S mode	J44 and J47 must both be set for correct S/PDIF receiver DAI format and word length
	1-2 / 2-3	24-bit I2S mode	
	2-3 / 1-2	24-bit left justified mode	
	2-3 / 2-3	16-bit right justified mode	
J45	1-2	DAI input level shift enable	
	2-3	DAI input level shift high impedance	
J46	1-2	DAI output level shift enable	
	2-3	DAI output level shift high impedance	
J48	On	S/PDIF receiver +5V supply enabled	
	Off	S/PDIF receiver +5V supply disabled	
J49	1-2	SPDIF word clock	Short links only if no sources are connected to J52
	3-4	SPDIF bit clock	
	5-6	SPDIF data	
	7-8	SPDIF master clock	

DA7210/11 USER MANUAL

J50	1-2	MCLK output	External connections
	3-4	CLK output	
	5-6	DATOUT output	
	7-8	WCLK output	
	11-12	SO output	
J51	On	Control interface 2-wire ISK selected	Short only if J55 links are removed
	Off	Control interface 2-wire ISK de-selected	
J52	1-2	DAI MCLK input	Short only if J49 links are removed
	3-4	DAI CLK input	
	5-6	DAI DATIN input	
	7-8	DAI WCLK input	
J53	On	Control interface 2-wire SO selected	Short only if J55 links removed
	Off	Control interface 2-wire SO de-selected	
J55	1-2	Control interface 4-wire nCS selected	Short only if J51 and J53 links removed
	3-4	Control interface 4-wire SI de-selected	
	5-6	Control interface 4-wire ISK selected	
J56	On	XVDDD connected to VDDCP	
	Off	XVDDD disconnected from VDDCP	
J57	On	XVDDD connected to VDDDIO	
	Off	XVDDD disconnected from VDDDIO	
J59	On	VDDCP connected to AVDD	
	Off	VDDCP disconnected from AVDD	
J60	On	REG_+1.8V supply connected	
	Off	REG_+1.8V disconnected	

Table 1 Jumpers and Link Positions

DA7210/11 USER MANUAL

The evaluation board can be set up to run solely from the +5V USB supply as the source for all board supplies. It is necessary to remove all external power supplies and to add jumpers J56, J57, J59 and J60 for this operation, which is the default configuration for the board.

The digital audio interface jumpers are set to receive a TOSLINK input and should be removed to accept other external clocks at J52. Figure 9 shows the extra links required to enable the onboard supplies.

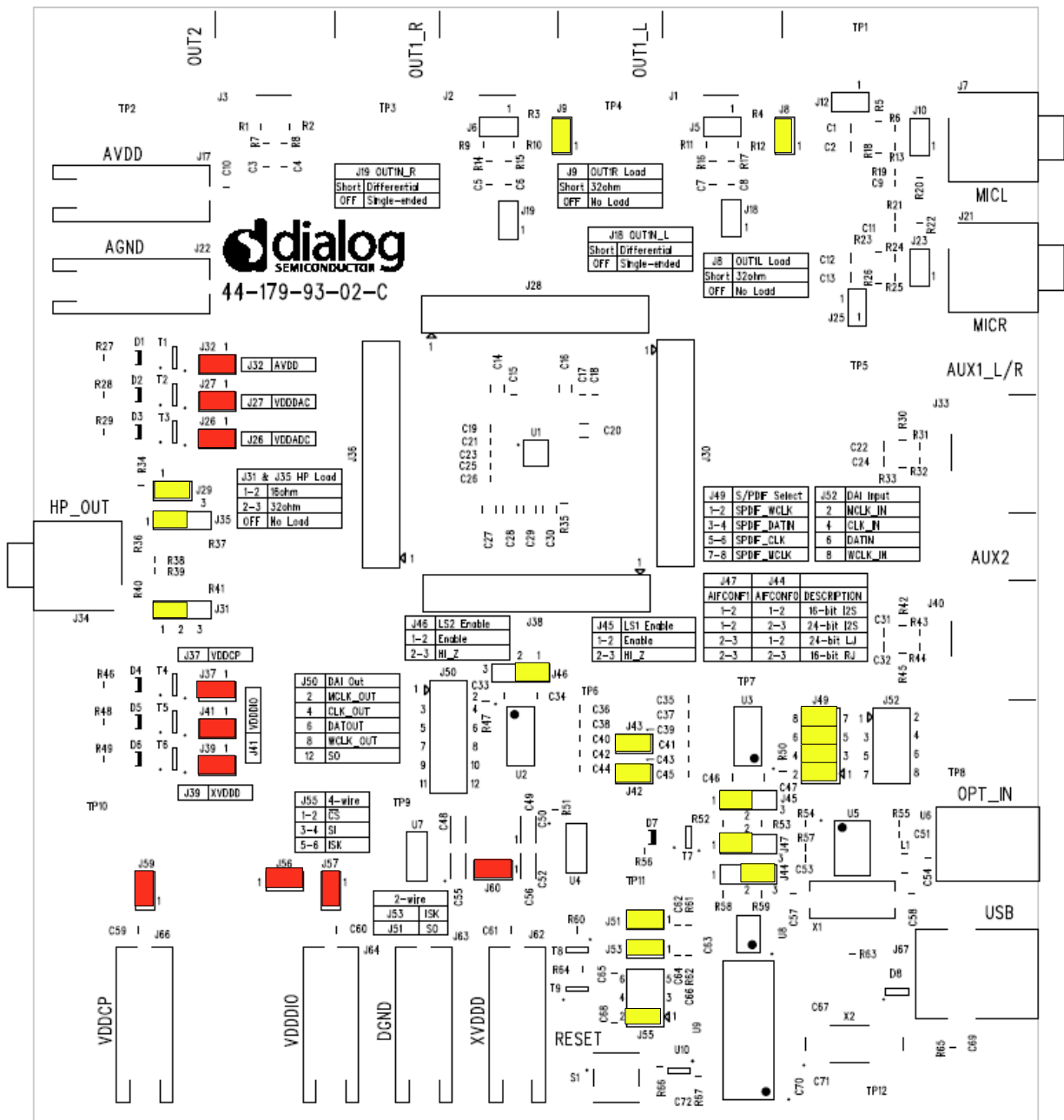

Figure 6 DA7210 Default Link locations

DA7210/11 USER MANUAL

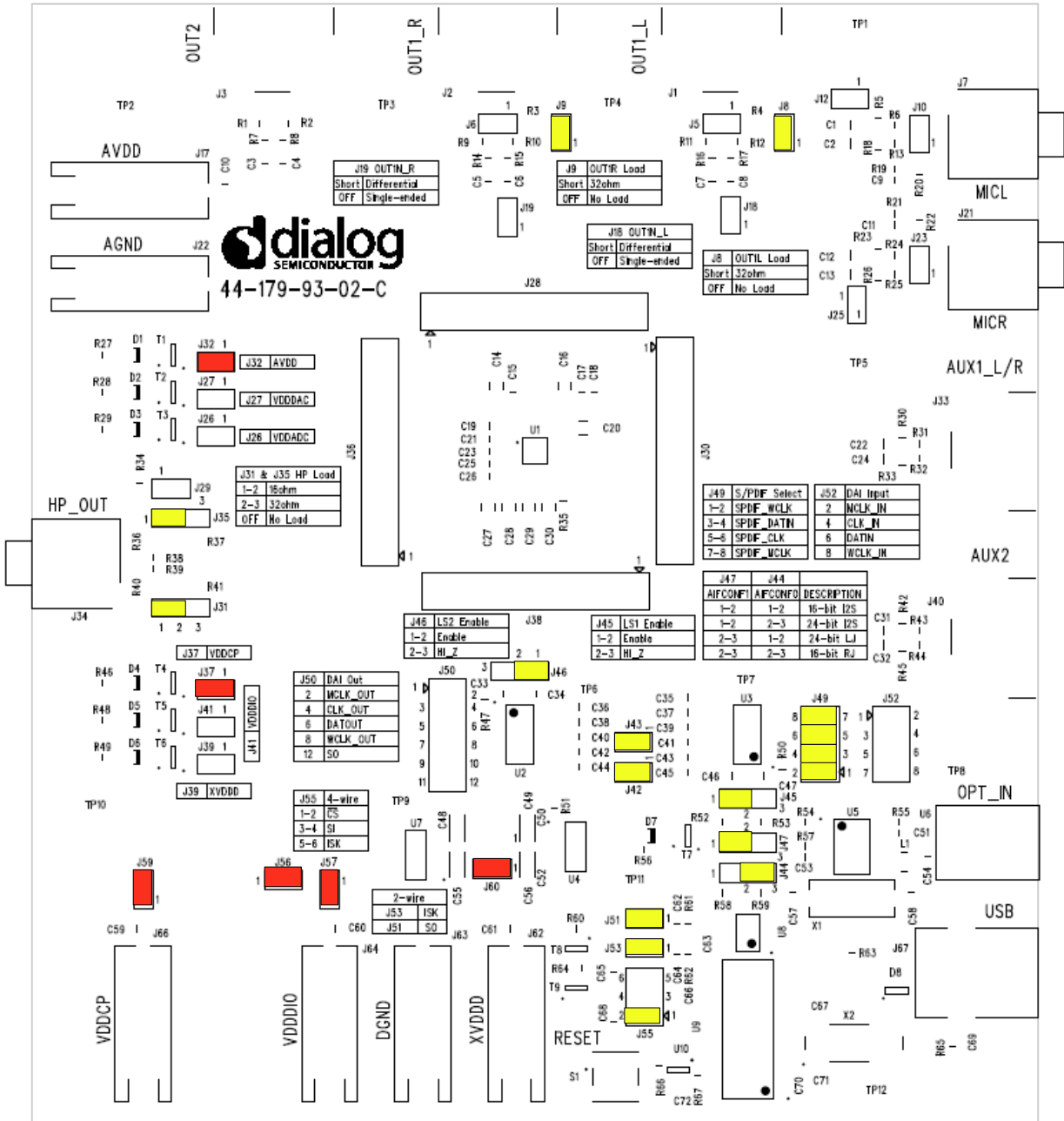

Figure 7 DA7211-00 Default Link Locations

DA7210/11 USER MANUAL

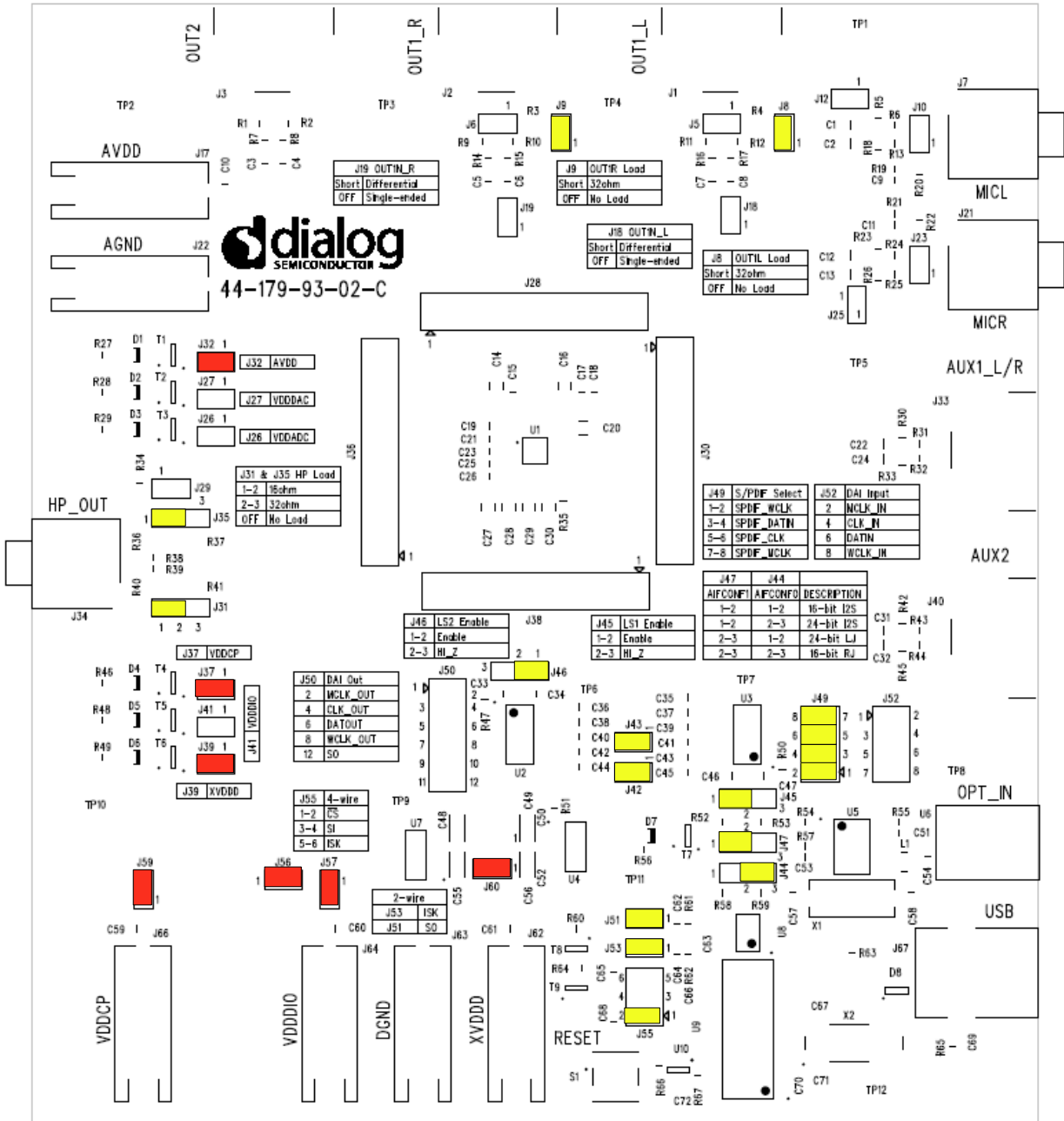

Figure 8 DA7211-01 Default Link Locations

DA7210/11 USER MANUAL

Figure 9 shows the locations of the jumper links when using the DA7210 with external power supplies to AVDD J66, VDDCP J17, XVDDD J62 and VDDDIO J64. The digital audio interface jumpers are set to receive a TOSLINK input and should be removed to accept other external I2S clocks at J52.

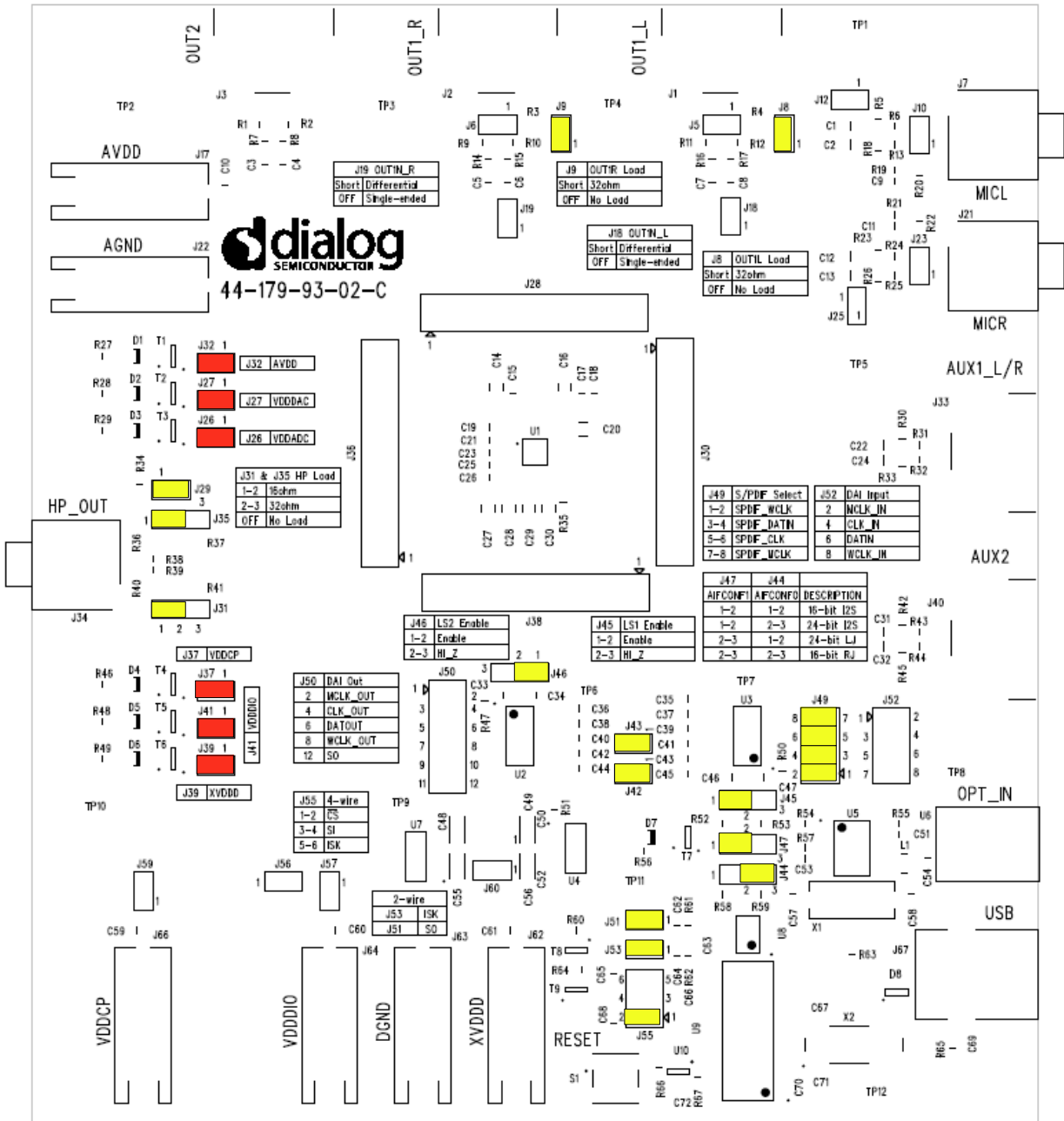

Figure 9 External Power Supply Jumper Configuration

DA7210/11 USER MANUAL

3 Evaluation Board Features

3.1 USB Interface

The USB Interface is used here for the following purposes:

- As a source of I2C and SPI control signals.
- To provide a discrete signal to the power down pin *PD* (DA7210 only).
- To provide level shifting voltages.
- To allow standalone operation of the evaluation board using the +5V_{dc} USB power supply only.

The USB control signal device is powered by the USB bus cable via a fixed +3.3V_{dc} regulator.

The USB interface control signals can be isolated from rest of the evaluation board by removing J51, J53 and J55 described in Table 1. Removing these jumpers will allow external signal access to the DA7210 control interface. The USB interface can also be used to supply the power supplies to the DUT on the evaluation board.

The USB Interface implements multi-mastering on its I2C interface, permitting concurrent operation with any other multi-mastering controller. This allows the software to control a DA7210/11 device which is already part of the users system, and under control of the system processor.

4 Control Software

4.1 Installation

Insert the DVD-ROM containing the software into the controlling PC. If the installation does not start automatically, run the program 'setup.exe' from the DVD-ROM containing the software. An automated script will install the program to your PC. By default, the directory 'C:\ProgramFiles\Dialog Semiconductor\Audio\DA7210 Rev x.x' will be used.

As Windows Vista imposes limitations on the 'C:\Program Files' directory, change this default to 'C:\Dialog Semiconductor\Audio\DA7210 Rev x.x' when prompted.

Plug in the USB cable, and Windows will detect the USB device. It will prompt for the drivers, which should be automatically located on the root directory of the DVD-ROM. The setup file is 'dlgezusb.inf' and the following description explains how to install the driver.



Select No, not this time and press Next >

DA7210/11 USER MANUAL

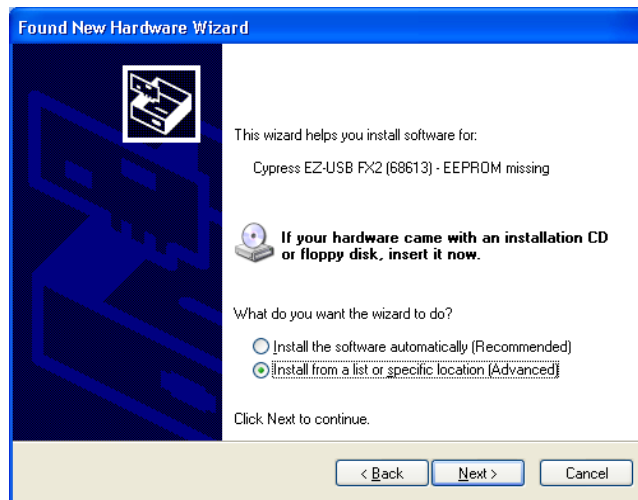

Select Install from a list or specific location (Advanced) and press Next >

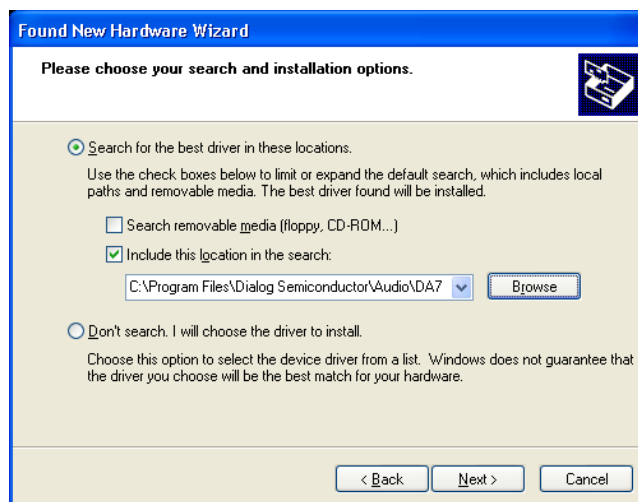

Select Browse and locate the folder

C:\Program Files\Dialog Semiconductor\Audio\DA7210_11 Rev x.x

DA7210/11 USER MANUAL

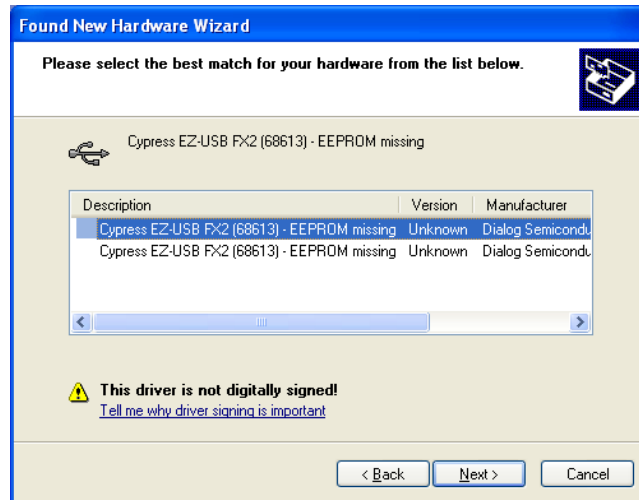

Select *dlgezusb.inf* and press *Next >*



Press Continue Anyway

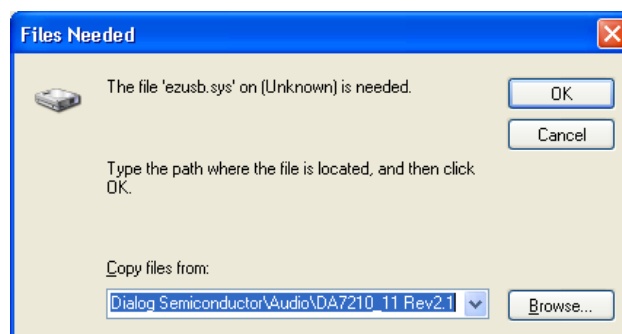

Select Browse and locate C:\Program Files\Dialog Semiconductor\Audio\DA7210_11 Rev x.x then press OK

DA7210/11 USER MANUAL

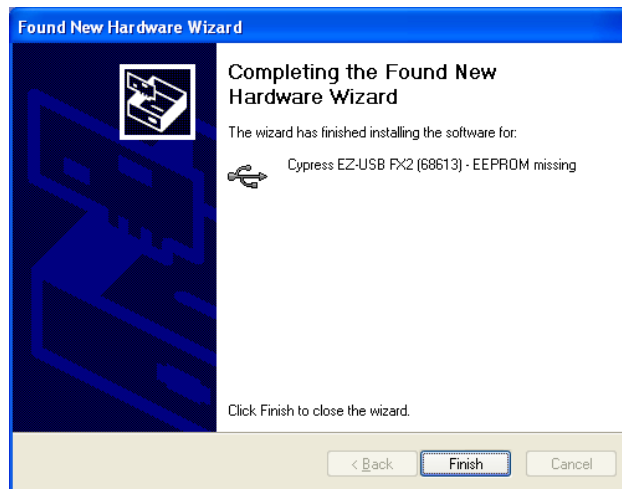

Select Finish

If you are using Windows XP, you may get a message saying that a USB2 device is attached to a USB1.1 port. This can safely be ignored.

To uninstall the software please use the Windows 'Add/Remove Programs' function that can be found under 'Start->Settings->Control Panel'.

4.2 Set-up Files

4.2.1 Text File

The DUT registers can be written to by submitting a text file containing the register values; Figure 10 shows an example file. Only the data in the first three columns is required: register, data, R/W; other comments, such as those shown in the example, will be ignored. Lines of text that do not follow register write entries should be preceded by // in order that the line is ignored when reading the text file.

The text file can be created by saving the first three columns of the template spreadsheet file above as a text file or can be created from scratch; it is only necessary for the text file to contain the registers required for set up all others can be omitted.

To add a delay in the file the register value is entered as *Delay* followed by the delay time required in milliseconds. The example in Figure 10 shows a 100ms delay added as the third entry.

DA7210/11 USER MANUAL

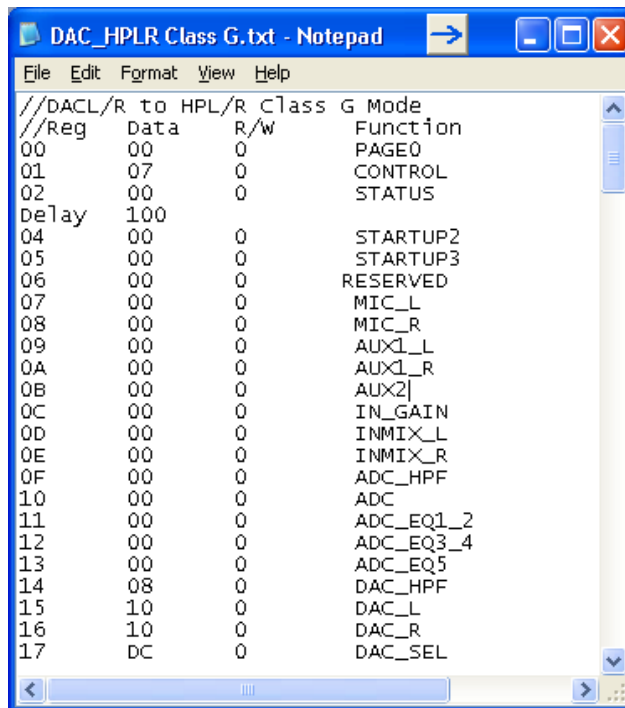

```
File Edit Format View Help
//DACL/R to HPL/R Class G Mode
//Reg Data R/W Function
00 00 0 PAGE0
01 07 0 CONTROL
02 00 0 STATUS
Delay 100
04 00 0 STARTUP2
05 00 0 STARTUP3
06 00 0 RESERVED
07 00 0 MIC_L
08 00 0 MIC_R
09 00 0 AUX1_L
0A 00 0 AUX1_R
0B 00 0 AUX2
0C 00 0 IN_GAIN
0D 00 0 INMIX_L
0E 00 0 INMIX_R
0F 00 0 ADC_HPF
10 00 0 ADC
11 00 0 ADC_EQ1_2
12 00 0 ADC_EQ3_4
13 00 0 ADC_EQ5
14 08 0 DAC_HPF
15 10 0 DAC_L
16 10 0 DAC_R
17 DC 0 DAC_SEL
```

Figure 10 Text Set-up File

A selection of text files can be found on the DVD containing the register control software setup files.

4.2.2 Spreadsheet File

The register settings can be prepared using a spreadsheet file template provided, Figure 11, and saved as a tab delimited text file like Figure 10. The only bits that can be altered on the spreadsheet are the individual register bits in columns G to N and the R/W bit in column O. If any of these bits are set to 1 the bit will be highlighted in green on the register map. If the bit default setting is 1 and the bit value is changed to 0 then the register map bit will be highlighted in grey. This highlighting allows easy visual reference to the register changes from the default settings.

DA7210/11 USER MANUAL

Register	Data	HW	Function	B7	B6	B5	B4	B3	B2	B1	B0	R	S	T	U	V	X	Y	Default
01	00	0	REG_PAGE	0	0	0	0	0	0	0	0	0	0	0	0	0	0	0	0
02	00	1	CONTROL	0	0	0	1	0	1	1	1	1	1	1	1	1	1	1	1
03	00	0	STATUS	0	0	0	0	0	0	0	0	0	0	0	0	0	0	0	0
04	00	0	MIC_L	0	0	0	0	0	0	0	0	0	0	0	0	0	0	0	0
05	00	0	MIC_R	0	0	0	0	0	0	0	0	0	0	0	0	0	0	0	0
06	00	0	AUX1	0	0	0	0	0	0	0	0	0	0	0	0	0	0	0	0
07	00	0	AUX2	0	0	0	0	0	0	0	0	0	0	0	0	0	0	0	0
08	00	0	INMIX_L	0	0	0	0	0	0	0	0	0	0	0	0	0	0	0	0
09	00	0	INMIX_R	0	0	0	0	0	0	0	0	0	0	0	0	0	0	0	0
0A	00	0	ALC_MAKR	0	0	0	0	0	0	0	0	0	0	0	0	0	0	0	0
0B	00	0	ALC_MN1	0	0	0	0	0	0	0	0	0	0	0	0	0	0	0	0
0C	00	0	ALC_NDIS	0	0	0	0	0	0	0	0	0	0	0	0	0	0	0	0
0D	00	0	ALC_ATT	0	0	0	0	0	0	0	0	0	0	0	0	0	0	0	0
0E	00	0	ALC_REL	0	0	0	0	0	0	0	0	0	0	0	0	0	0	0	0
0F	00	0	ALC_DEL	0	0	0	0	0	0	0	0	0	0	0	0	0	0	0	0
10	00	0	ALC_CONT	0	0	0	0	0	0	0	0	0	0	0	0	0	0	0	0
11	08	0	ADC_HPF	0	0	0	0	1	0	0	0	0	0	0	0	0	0	0	1000
12	00	0	ADC	0	0	0	0	0	0	0	0	0	0	0	0	0	0	0	0
13	00	0	ADC_EQ1_2	0	0	0	0	0	0	0	0	0	0	0	0	0	0	0	0
14	00	0	ADC_EQ3_4	0	0	0	0	0	0	0	0	0	0	0	0	0	0	0	0
15	00	0	ADC_EQ5	0	0	0	0	0	0	0	0	0	0	0	0	0	0	0	0
16	54	0	DAC_SEL	0	1	0	1	0	1	0	0	0	0	0	0	0	0	0	100000
17	08	0	DAC_HPF	0	0	0	0	1	0	0	0	0	0	0	0	0	0	0	1000
18	88	0	DAC	1	0	0	0	1	0	0	0	0	0	0	0	0	0	0	0
19	00	0	DAC_EQ1_2	0	0	0	0	0	0	0	0	0	0	0	0	0	0	0	0
1A	00	0	DAC_EQ3_4	0	0	0	0	0	0	0	0	0	0	0	0	0	0	0	0
1B	00	0	DAC_EQ5	0	0	0	0	0	0	0	0	0	0	0	0	0	0	0	0
1C	00	0	DAC_SOFT_MUTE	0	0	0	0	0	0	0	0	0	0	0	0	0	0	0	0
1D	00	0	OUTMIX_L	1	0	0	1	0	0	0	0	0	0	0	0	0	0	0	0
1E	80	0	OUTMIX_R	1	0	0	1	0	0	0	0	0	0	0	0	0	0	0	0
1F	85	0	OUT1_L	1	0	1	0	1	0	1	0	0	0	0	0	0	0	0	0
20	85	0	OUT1_R	1	0	1	0	1	0	1	0	0	0	0	0	0	0	0	0
21	00	0	OUT2	0	0	0	0	0	0	0	0	0	0	0	0	0	0	0	0
22	00	0	HP_L_VOL	0	0	0	0	0	0	0	0	0	0	0	0	0	0	0	0
23	00	0	HP_R_VOL	0	0	0	0	0	0	0	0	0	0	0	0	0	0	0	0
24	00	0	HP_CONT	0	0	0	0	0	0	0	0	0	0	0	0	0	0	0	0
25	00	0	ZEROX	0	0	0	0	0	0	0	0	0	0	0	0	0	0	0	0
26	78	0	DAI_SRC_SEL	0	1	1	0	1	1	0	0	0	0	0	0	0	0	0	11010
27	08	0	DAI_CONF1	0	0	0	0	0	1	1	0	0	0	0	0	0	0	0	0
28	00	0	DAI_CONF2	0	0	0	0	0	0	0	0	0	0	0	0	0	0	0	0
29	80	0	DAI_CONF3	1	0	0	0	0	0	0	0	0	0	0	0	0	0	0	0
2A	00	0	FLL_DMT	0	0	0	0	0	0	0	0	0	0	0	0	0	0	0	0
2B	00	0	FLL_DV2	0	0	0	0	0	0	0	0	0	0	0	0	0	0	0	0
2C	40	0	FLL_DV3	0	1	0	0	0	0	0	0	0	0	0	0	0	0	0	10000
2D	00	0	FLL	0	0	0	0	1	0	1	1	0	0	0	0	0	0	0	10000
2E	00	0	GPIA_A0L	0	0	0	0	0	0	0	0	0	0	0	0	0	0	0	0
2F	00	0	GPIA_A0H	0	0	0	0	0	0	0	0	0	0	0	0	0	0	0	0
30	00	0	GPIB_A0L	0	0	0	0	0	0	0	0	0	0	0	0	0	0	0	0
31	00	0	GPIB_A0H	0	0	0	0	0	0	0	0	0	0	0	0	0	0	0	0
32	00	0	GPI_C_A0L	0	0	0	0	0	0	0	0	0	0	0	0	0	0	0	0
33	00	0	GPI_C_A0H	0	0	0	0	0	0	0	0	0	0	0	0	0	0	0	0
34	00	0	GPI_D_A0L	0	0	0	0	0	0	0	0	0	0	0	0	0	0	0	0
35	00	0	GPI_D_A0H	0	0	0	0	0	0	0	0	0	0	0	0	0	0	0	0
36	00	0	GP2A_A0L	0	0	0	0	0	0	0	0	0	0	0	0	0	0	0	0
37	00	0	GP2A_A0H	0	0	0	0	0	0	0	0	0	0	0	0	0	0	0	0
38	00	0	GP2B_A0L	0	0	0	0	0	0	0	0	0	0	0	0	0	0	0	0
39	00	0	GP2B_A0H	0	0	0	0	0	0	0	0	0	0	0	0	0	0	0	0
3A	00	0	GP2C_A0L	0	0	0	0	0	0	0	0	0	0	0	0	0	0	0	0
3B	00	0	GP2C_A0H	0	0	0	0	0	0	0	0	0	0	0	0	0	0	0	0
3C	00	0	GP2D_A0L	0	0	0	0	0	0	0	0	0	0	0	0	0	0	0	0

Figure 11 Spreadsheet Set-up File

DA7210/11 USER MANUAL

4.3 Control Panels

Run the DA7210/11 program by clicking the shortcut on the appropriate item in the Start menu. The best setting for the PC display size is 1024x768 pixels or above. Font size on the PC display should be Normal (95dpi). It is important to note that a display size other than the recommended setting may affect the way in which the panels appear.

4.3.1 Front Panel

The front panel allows selection of a number of methods for programming the registers of the DUT.

- Submit a text file template, which allows register sequencing and time delays to be added.
- Select register map page 0 for individual register read/write access.
- Select register map page 1 for individual register write access.
- Select general purpose filters register map for individual register write access.
- Open a panel to access the volume control registers for real time volume control.
- Direct read/write access to a single register.

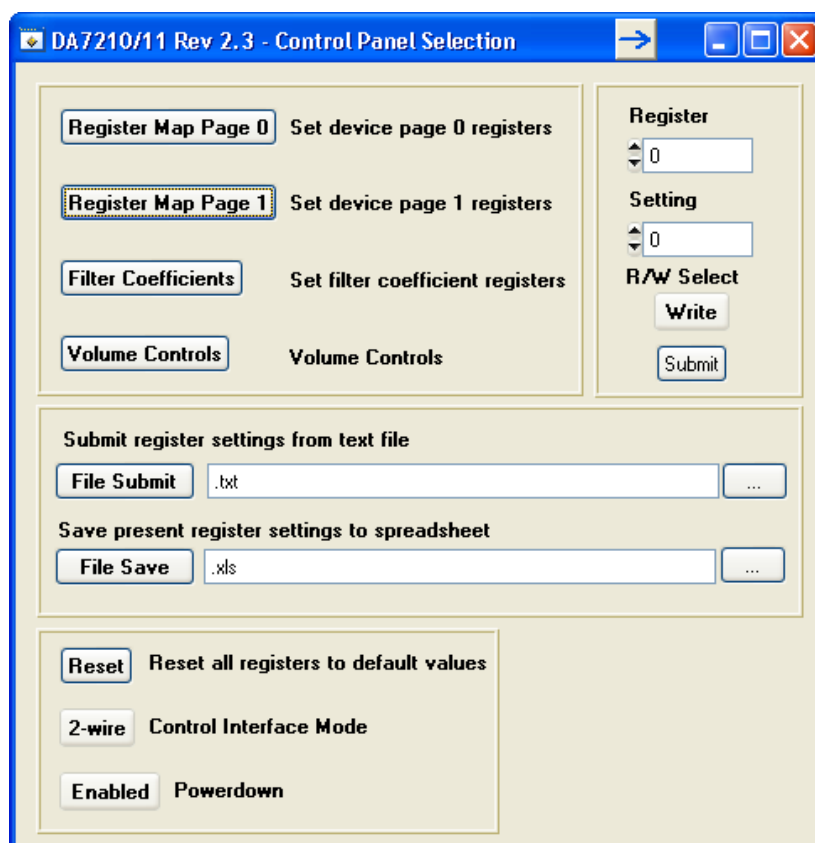

Figure 12 Front Panel

Any file path required can be opened using the ‘...’ button to the right of the corresponding text box, but it must then be submitted or saved using the submit button to the left of the corresponding text box.

DA7210/11 USER MANUAL

It is possible to save the present register settings by selecting a spreadsheet file by locating the filename path using the 'Save present register setting to spreadsheet' box. This function will not read back the device registers, but will only output the values shown on Page 0 and Page 1 of the GUI.

The front panel also contains a reset button, a device power down button and 2-wire/4-wire control selection.

4.3.2 Register Map Page 0

The page 0 register map panel allows read/write access to single bits or to the hex value of a single register; both can be submitted individually.

Register	R/W	B7	B6	B5	B4	B3	B2	B1	B0	Hex	Submit	FUNCTION	7	6	5	4	3	2	1	0	DEFAULT
0x00	W	0	0	0	0	0	0	0	0	0	-	PAGE0	REG_PAGE								0
0x01	W	0	0	0	1	0	0	0	0	10	-	CONTROL	WRITE_MODE		ATB1_LEV	ATB1_SEL	NOISE_SUP	BIAS_EN	VDDIO_RANGE	REG_EN	10000
0x02	R	0	0	0	0	0	0	0	0	0	-	STATUS					MUTING	SOFTMUTED	I2S_LOCK	PLL_LOCK	0
0x03	W	0	0	0	0	0	0	0	0	0	-	STARTUP1	SC_CLK_DIS		SC_OVERRIDE					SC_MST_EN	0
0x04	W	0	0	0	0	0	0	0	0	0	-	STARTUP2							STARTUP2[6:0]		0
0x05	W	0	0	0	0	0	0	0	0	0	-	STARTUPS							STARTUPS[6:0]		0
0x06	W	0	0	0	0	0	0	0	0	0	-	RESERVED							RESERVED		0
0x07	W	0	0	0	0	0	0	0	0	0	-	MIC_L	MIC_L_EN	MICBIAS_EN	MICBIAS_SEL[1:0]	MIC_L_MUTE		MIC_L_VOL[2:0]			0
0x08	W	0	0	0	0	0	0	0	0	0	-	MIC_R	MIC_R_EN			MIC_R_MUTE		MIC_R_VOL[2:0]			0
0x09	W	0	0	0	1	0	0	0	0	10	-	AUX1_L	AUX1_L_EN				AUX1_L_VOL[6:0]				10000
0x0A	W	0	0	0	1	0	0	0	0	10	-	AUX1_R	AUX1_R_EN				AUX1_R_VOL[6:0]				10000
0x0B	W	0	0	0	0	0	0	0	0	0	-	AUX2				AUX2_EN	AUX2_MUTE	AUX2_VOL[1:0]			0
0x0C	W	0	0	0	0	0	0	0	0	0	-	IN_GAIN		INPGA_R_VOL[3:0]				INPGA_L_VOL[3:0]			0
0x0D	W	0	0	0	0	0	0	0	0	0	-	INMIX_L	IN_L_EN					IN_L_SEL[4:0]			0
0x0E	W	0	0	0	0	0	0	0	0	0	-	INMIX_R	IN_R_EN					IN_R_SEL[6:0]			0
0x0F	W	0	0	0	1	0	0	0	0	8	-	ADC_HPF	ADC_VOICE_EN		ADC_VOICE_F0[2:0]		ADC_HPF_EN		ADC_HPF_F0[1:0]		1000
0x10	W	0	0	0	0	0	0	0	0	0	-	ADC	ADC_R_EN	ADC_R_MUTE			ADC_L_EN	ADC_L_MUTE		ALC_EN	0
0x11	W	0	0	0	0	0	0	0	0	0	-	ADC_EQ1_2		ADC_EQ2_VOL[8:0]				ADC_EQ1_VOL[8:0]			0
0x12	W	0	0	0	0	0	0	0	0	0	-	ADC_EQ3_4		ADC_EQ4_VOL[8:0]				ADC_EQ3_VOL[8:0]			0
0x13	W	0	0	0	0	0	0	0	0	0	-	ADC_EQ5	ADC_EQ_EN		ADC_EQ_GAIN[1:0]			ADC_EQ5_VOL[8:0]			0
0x14	W	0	0	0	1	0	0	0	0	8	-	DAC_HPF	DAC_VOICE_EN		DAC_VOICE_F0[2:0]		DAC_HPF_EN	DAC_MUTE		DAC_HPF_F0[1:0]	1000
0x15	W	0	0	0	1	0	0	0	0	10	-	DAC_L	DAC_L_INV				DAC_L_GAIN[6:0]				10000
0x16	W	0	0	0	1	0	0	0	0	10	-	DAC_R	DAC_R_INV				DAC_R_GAIN[6:0]				10000
0x17	W	0	1	0	1	0	1	0	0	54	-	DAC_SEL	DAC_R_EN		DAC_R_SRC[2:0]		DAC_L_EN		DAC_L_SRC[2:0]		1010100
0x18	W	0	1	0	0	0	0	0	0	40	-	SOFT_MUTE	SOFT_MUTE	RAMP_EN				MUTE_RATE[2:0]			10000000
0x19	W	0	0	0	0	0	0	0	0	0	-	DAC_EQ1_2		DAC_EQ2_VOL[8:0]				DAC_EQ1_VOL[8:0]			0
0x1A	W	0	0	0	0	0	0	0	0	0	-	DAC_EQ3_4		DAC_EQ4_VOL[8:0]				DAC_EQ3_VOL[8:0]			0
0x1B	W	0	0	0	0	0	0	0	0	0	-	DAC_EQ5	DAC_EQ_EN					DAC_EQ5_VOL[8:0]			0
0x1C	W	0	0	0	0	0	0	0	0	0	-	OUTMIX_L	OUT_L_EN	OUT_L_INV				OUT_L_SEL[4:0]			0
0x1D	W	0	0	0	0	0	0	0	0	0	-	OUTMIX_R	OUT_R_EN	OUT_R_INV				OUT_R_SEL[4:0]			0
0x1E	W	0	0	1	1	0	1	0	1	35	-	OUT1_L	OUT1_L_EN	OUT1_L_SE				OUT1_L_VOL[6:0]			110101
0x1F	W	0	0	1	1	0	1	0	1	35	-	OUT1_R	OUT1_R_EN	OUT1_R_SE				OUT1_R_VOL[6:0]			110101
0x20	W	0	0	0	0	0	1	1	3	-	OUT2	OUT2_EN		OUT2_SEL[8:0]				OUT2_VOL[2:0]			11
0x21	W	0	0	0	1	0	0	0	10	-	HP_L_VOL		HP_L_INV					HP_L_VOL[6:0]			10000
0x22	W	0	0	0	1	0	0	0	10	-	HP_R_VOL		HP_R_INV					HP_R_VOL[6:0]			10000
0x23	W	0	0	0	0	0	1	0	2	-	HP_CFG	HP_R_EN	HP_MODE	STEREO_TRACK	HP_HIGHZ_R	HP_L_EN	HP_SENSE_EN	HP_2CAP_MODE	HP_HIGHZ_L		10
0x24	W	0	0	0	0	0	0	0	0	-	ZEROX	HPZX_R_EN	HPZX_L_EN	OUTZX_S_EN	OUTZX_L_EN	INZX_R_EN	INZX_L_EN	A1ZX_R_EN	A1ZX_L_EN		0
0x25	W	0	1	1	1	0	1	1	75	-	DAI_SRC_SEL	DAI_IN_R_MIX		DAI_OUT_R_SRC[2:0]		DAI_IN_L_MIX		DAI_OUT_L_SRC[2:0]			1110110
0x26	W	0	0	0	0	0	0	0	0	-	DAI_CFG1	DAI_MODE		DAI_TDM_MONO		DAI_FRAME[1:0]		DAI_WORD[1:0]			0
0x27	W	0	0	0	0	0	0	0	0	-	DAI_CFG2			DAI_TDM_OFFS[7:0]							0
0x28	W	0	0	0	1	0	0	0	8	-	DAI_CFG3	DAI_EN			DAI_OE	DAI_TDM		DAI_FORMAT[1:0]			1000
0x29	W	0	0	0	0	0	0	0	0	-	PLL_DIV1				PLL_DIV_H[19:12]						0
0x2A	W	0	0	0	0	0	0	0	0	-	PLL_DIV2				PLL_DIV_M[11:4]						0
0x2B	W	0	0	0	1	0	0	0	10	-	PLL_DIV3		PLL_BYP	MCLK_RANGE[1:0]				PLL_DIV_L[6:0]			10000
0x2C	W	0	0	0	1	0	1	0	A	-	PLL	PLL_EN	MCLK_SRM_EN	MCLK_DET_EN	MCLK_SHAPE_EN			F0[8:0]			1010

Figure 13 Register Map Page 0

To select readback of an individual register click on the R/W bit of the required register and select R. To read the value press the submit button of the same row.

DA7210/11 USER MANUAL

Register Map Page 0													
Register	R/W	B7	B6	B5	B4	B3	B2	B1	B0	Hex	Submit	FUNCTION	
0x00	W	0	0	0	0	0	0	0	0	0	-	PAGE0	REG_P0
0x01	W	0	0	0	1	0	0	0	0	10	-	CONTROL	WRITE_M
0x02	R	0	0	0	0	0	0	0	0	0	-	STATUS	
0x03	W	0	0	0	0	0	0	0	0	0	-	STARTUP1	SC_CLK
0x04	W	0	0	0	0	0	0	0	0	0	-	STARTUP2	
0x05	W	0	0	0	0	0	0	0	0	0	-	STARTUP3	
0x06	W	0	0	0	0	0	0	0	0	0	-	RESERVED	
0x07	W	0	0	0	0	0	0	0	0	0	-	MIC_L	MIC_L
0x08	R	0	0	0	0	0	0	0	0	0	-	MIC_R	MIC_R
0x09	W	0	0	0	1	0	0	0	0	10	-	AUX1_L	AUX1_L
0x0A	W	0	0	0	1	0	0	0	0	10	-	AUX1_R	AUX1_R
0x0B	W	0	0	0	0	0	0	0	0	0	-	AUX2	
0x0C	W	0	0	0	0	0	0	0	0	0	-	IN_GAIN	
0x0D	W	0	0	0	0	0	0	0	0	0	-	INMIX_L	IN_L
0x0E	W	0	0	0	0	0	0	0	0	0	-	INMIX_R	IN_R

Figure 14 Selecting Individual Register Readback

A pop up window will then appear displaying the readback value of the register, Figure 15.

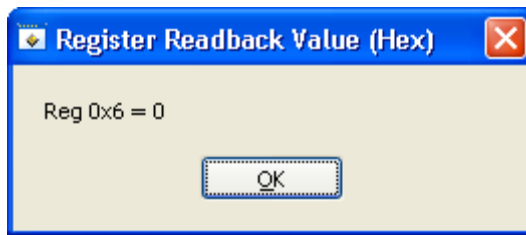

Figure 15 Readback Pop-up Window

To select readback of all Page 0 register simultaneously press the read all button at the base of the R/W column. This will write the register readback values to a spreadsheet file at the following location: *C:\Program Files\Dialog Semiconductor\Audio\DA7210_11 Rev x.x \Page0_Readback_Values.xls*

Register Map Page 0													
Register	R/W	B7	B6	B5	B4	B3	B2	B1	B0	Hex	Submit	FUNCTION	
0x21	W	0	0	1	1	0	1	0	1	35	-	HP_L	
0x22	W	0	0	1	1	0	1	0	1	35	-	HP_R	
0x23	W	1	0	1	0	1	1	1	0	AE	-	HP	
0x24	W	1	1	0	0	0	0	0	0	C0	-	ZER	
0x25	W	0	1	1	1	0	1	1	0	76	-	DAI_SF	
0x26	W	0	0	0	0	0	1	1	0	6	-	DAI	
0x27	W	0	0	0	0	0	0	0	0	0	-	DAI	
0x28	W	1	0	0	0	0	0	0	0	80	-	DAI	
0x29	W	0	0	0	0	0	0	0	0	0	-	PLL	
0x2A	W	0	0	0	0	0	0	0	0	0	-	PLL	
0x2B	W	0	1	0	1	0	0	0	0	50	-	PLL	
0x2C	W	0	0	0	0	1	0	1	1	B	-	P	

Read All Submit All Reset

Figure 16 Readback All Registers

4.3.3 Register Map Page 1

The page 1 register map panel allows access to single bits or to the hex value of a single register; both can be submitted individually. Readback from Page 1 registers is limited, but individual register readback can be selected in the same way as Page 1 where available.

DA7210/11 USER MANUAL

Disabled	Page 1 Enable (4-wire mode only)	Reset Table	FUNCTION	7	6	5	4	3	2	1	0	DEFAULT
0x80	w	0	PAGE1	REG_PAGE								0
0x81	r	0	CHIP_ID		MRCI[3:0]				MMRCE[3:0]			12001
0x82	r	0	INTERFACE	F_BASE_ADDR[2:0]			NCS_POL	RAW_POL	CPHA	CPOL	OTP_FUSED	101100
0x83	w	0	ALC_MAX	ALC_MERGE					ALC_MAX[5:0]			1030000
0x84	w	0	ALC_MIN						ALC_MIN[5:0]			0
0x85	w	0	ALC_NOIS						ALC_NOIS[5:0]			0
0x86	w	0	ALC_ATT				ALC_ATT[7:0]					0
0x87	w	0	ALC_REL				ALC_REL[7:0]					0
0x88	w	0	ALC_DEL				ALC_DEL[7:0]					0
0x8A	w	1	A_HD_UNLOCK						HDDEN[7:0]			10001011
0x8B	w	1	A_TST_UNLOCK						TEST[7:0]			10110100
0x90	w	0	A_PLL1								VDCRST_EN	0
0x95	w	0	A_ADC0					ADC_Tz				0
0x96	w	0	A_DAC0						VMD_BUFF_EN2	VMD_BUFF_EN	VMD_BUFF_EN2	111
0xA7	w	0	A_CP_MODE	VDC_EN	YDD2_EN	YDD0_EN	YDD4_EN	YDD4_ER	HP_LVL_DET	DAC_LVL_DET	VOL_LVL_DET	11111110
0xB7	w	0	A_B3A3		DIGREG_CNTL1		DIGREG_CNTL0					0

Figure 17 Register Map Page 1

4.3.4 GP Filters Register Map

The general purpose filters register map panel allows access to the hex value of a single register; all registers are submitted after changes. All registers may also be reset using the *Reset Filters* button.

2E	GP1A_A0L	38	GP1D_A0L	42	GP2A_A1L	4C	GP2D_A1L	56	GP1C_A2L	60	GP1B_B1L	6A	GP2C_B1L	74	GP2B_B2L
2F	GP1A_A0H	39	GP1D_A0H	43	GP2A_A1H	4D	GP2D_A1H	57	GP1C_A2H	61	GP1B_B1H	6B	GP2C_B1H	75	GP2B_B2H
30	GP1B_A0L	3A	GP2C_A0L	44	GP2B_A1L	4E	GP1A_A2L	58	GP1D_A2L	62	GP2A_B1L	6C	GP2D_B1L	76	GP1C_B2L
31	GP1B_A0H	3B	GP2C_A0H	45	GP2B_A1H	4F	GP1A_A2H	59	GP1D_A2H	63	GP2A_B1H	6D	GP2D_B1H	77	GP1C_B2H
32	GP2A_A0L	3C	GP2D_A0L	46	GP1C_A1L	50	GP1B_A2L	5A	GP2C_A2L	64	GP2B_B1L	6E	GP1A_B2L	78	GP1D_B2L
33	GP2A_A0H	3D	GP2D_A0H	47	GP1C_A1H	51	GP1B_A2H	5B	GP2C_A2H	65	GP2B_B1H	6F	GP1A_B2H	79	GP1D_B2H
34	GP2B_A0L	3E	GP1A_A1L	48	GP1D_A1L	52	GP2A_A2L	5C	GP2D_A2L	66	GP1C_B1L	70	GP1B_B2L	7A	GP2C_B2L
35	GP2B_A0H	3F	GP1A_A1H	49	GP1D_A1H	53	GP2A_A2H	5D	GP2D_A2H	67	GP1C_B1H	71	GP1B_B2H	7B	GP2C_B2H
36	GP1C_A0L	40	GP1B_A1L	4A	GP2C_A1L	54	GP2B_A2L	5E	GP1A_B1L	68	GP1D_B1L	72	GP2A_B2L	7C	GP2D_B2L
37	GP1C_A0H	41	GP1B_A1H	4B	GP2C_A1H	55	GP2B_A2H	5F	GP1A_B1H	69	GP1D_B1H	73	GP2A_B2H	7D	GP2D_B2H

FILTER COEFFICIENT REGISTERS

0x2D 0 0x37 0 0x41 0 0x4B 0 0x55 0 0x5F 0 0x69 0 0x73 0

0x2E 0 0x38 0 0x42 0 0x4C 0 0x56 0 0x60 0 0x6A 0 0x74 0

0x2F 0 0x39 0 0x43 0 0x4D 0 0x57 0 0x61 0 0x6B 0 0x75 0

0x30 0 0x3A 0 0x44 0 0x4E 0 0x58 0 0x62 0 0x6C 0 0x76 0

0x31 0 0x3B 0 0x45 0 0x4F 0 0x59 0 0x63 0 0x6D 0 0x77 0

0x32 0 0x3C 0 0x46 0 0x50 0 0x5A 0 0x64 0 0x6E 0 0x78 0

0x33 0 0x3D 0 0x47 0 0x51 0 0x5B 0 0x65 0 0x6F 0 0x79 0

0x34 0 0x3E 0 0x48 0 0x52 0 0x5C 0 0x66 0 0x70 0 0x7A 0

0x35 0 0x3F 0 0x49 0 0x53 0 0x5D 0 0x67 0 0x71 0 0x7B 0

0x36 0 0x40 0 0x4A 0 0x54 0 0x5E 0 0x68 0 0x72 0 0x7C 0

Submit Filters Reset Filters GP1AB/2AB - 0x7D 34 GP1CD/2CD - 0x7E 75 GP Enable - 0x7F 0

Figure 18 Filter Coefficients Set-up Panel

An alternative 'RT Filters' GUI is available that allows easy submission of any of the DAC or ADC filters paths present within the DA7210/11. This is contained on the installation DVD within the distribution kit.

DA7210/11 USER MANUAL

4.3.5 Volume Control Panel

The *Volume Control* panel allows real time changes to any of the analogue input or output PGAs within the DUT. Muting is also possible where this function exists.

Gain controls are available to the following PGAs:

- AUX_L and AUX_R
- MIC_L and MIC_R
- A2 PGA
- Left and Right Input PGAs
- OUT1_L and OUT1_R
- HPL and HPR
- OUT2

It is possible to change the headphone and OUT1 gain control registers as stereo pairs by simultaneously selecting the *HPL follow HPR* and *OUT1L follow OUT1R* buttons.

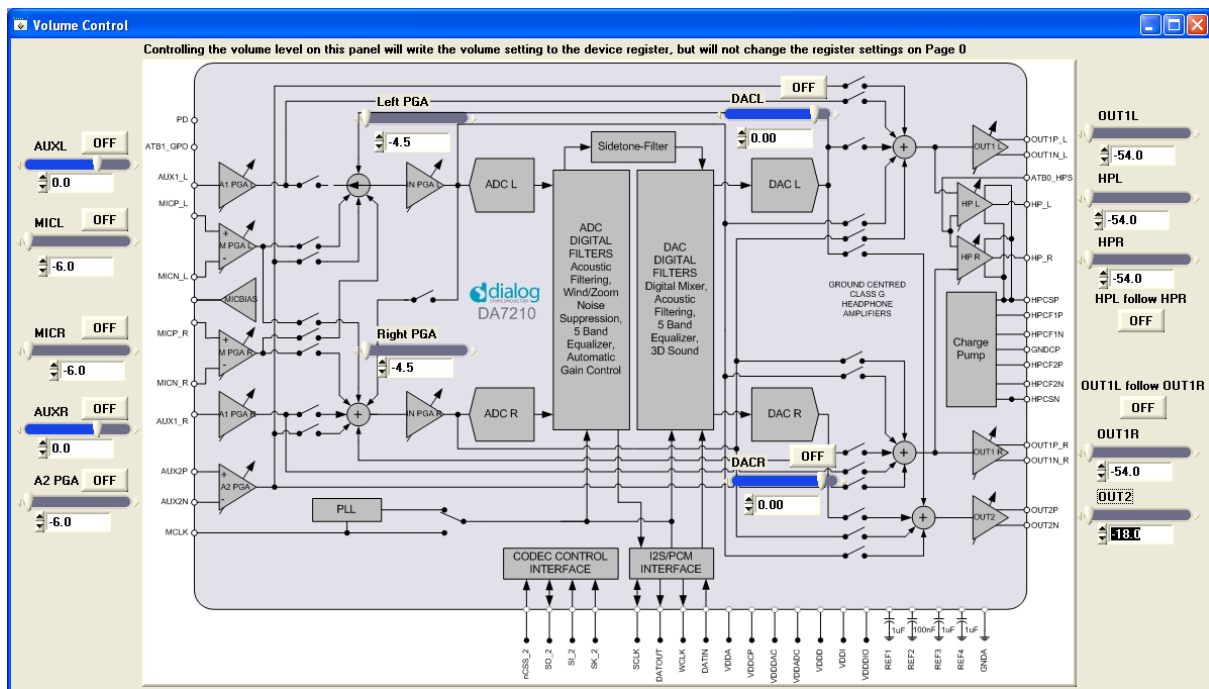

Figure 19 Volume Control Panel

DA7210/11 USER MANUAL

5 RT Filters GUI

The RT filters GUI allows easy control of all the filter options within the DA7210/11 device through USB control. This includes general purpose filters, five-band equalisers and voice filters for ADC and DAC.

The *Filter Setup* page makes it possible to design the required filter response for all of the general purpose filter bi-quad IIR paths available in the DA7210/11.

5.1 Software Installation

The set-up file for the RT Filters control software can be found on the accompanying DVD in the folder *DA7210 RT Filters Rev x.x*

Double click *setup.exe* file and the install will begin.

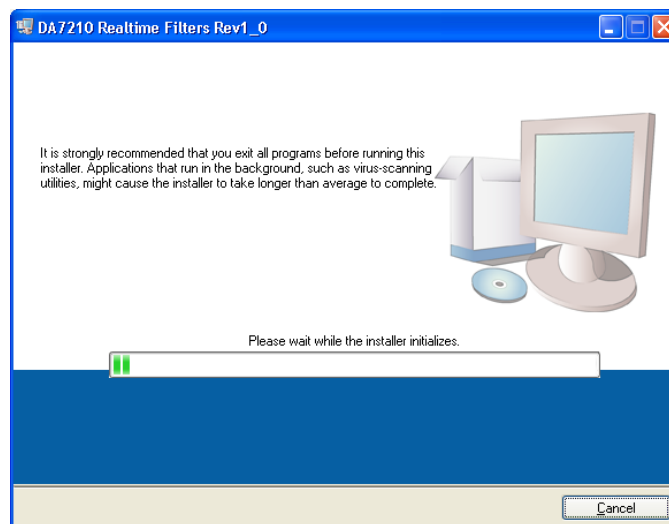

Do not change the installation directory or necessary license files will not be accessible.

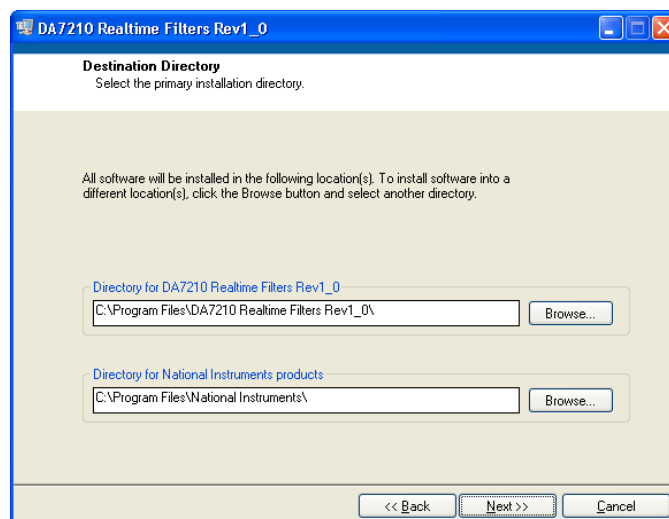

DA7210/11 USER MANUAL

Select I accept the License Agreement and press Next>>

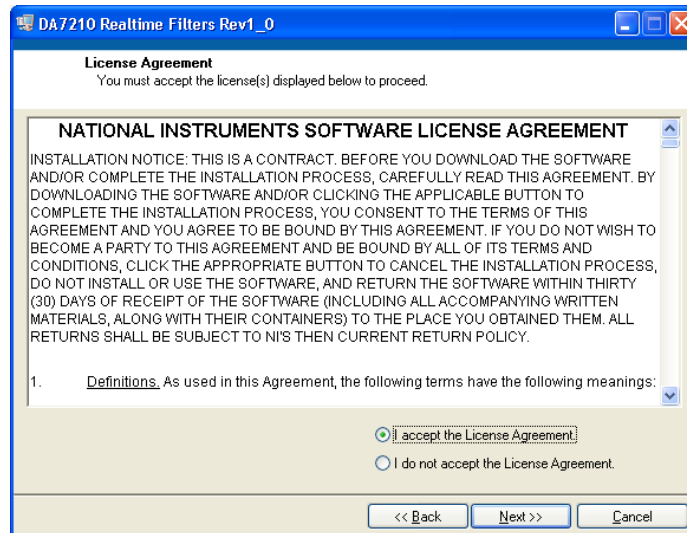

Press Next>>

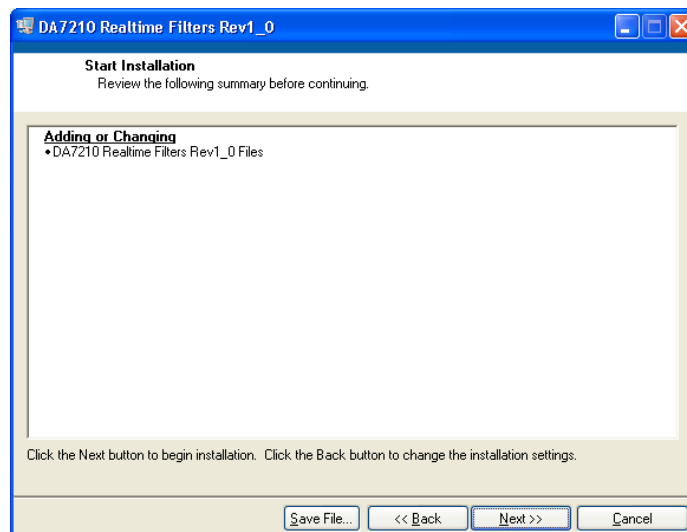

Allow the application to install. If Labview run-time files have not been installed on the target computer previously, the installation may take a few minutes.

DA7210/11 USER MANUAL

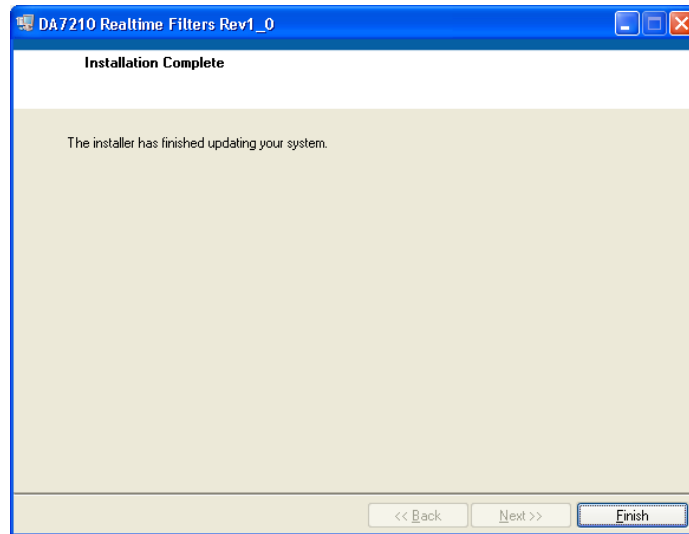

When installation is complete press *Finish*

5.2 Control Panels

5.2.1 Running the Interface and USB Initialisation

The *RT Filters Rev x.x* GUI can be used in conjunction with the *DA7210_11 Register Control Software Rev x.x* to set up the DA7210/11 device registers. In order to allow both interfaces to access the DA7210/11 simultaneously it is necessary to initialise the *RT Filters* GUI first before opening the *DA7210_11 Register Control Software*.

The flowchart in Figure 20 details the start-up procedure when using the DA7210 Register Control GUI and RT Filter GUI in conjunction with each other.

On starting-up the *RT Filters* application the interface will be running. Once the coefficients are calculated the interface will stop and the registers writes will be submitted to the DA7210/11. To start the interface running again, press the white arrow situated below the *Operate* drop down menu on the top row; this will turn to black and the interface is running again ready for new selections.

DA7210/11 USER MANUAL

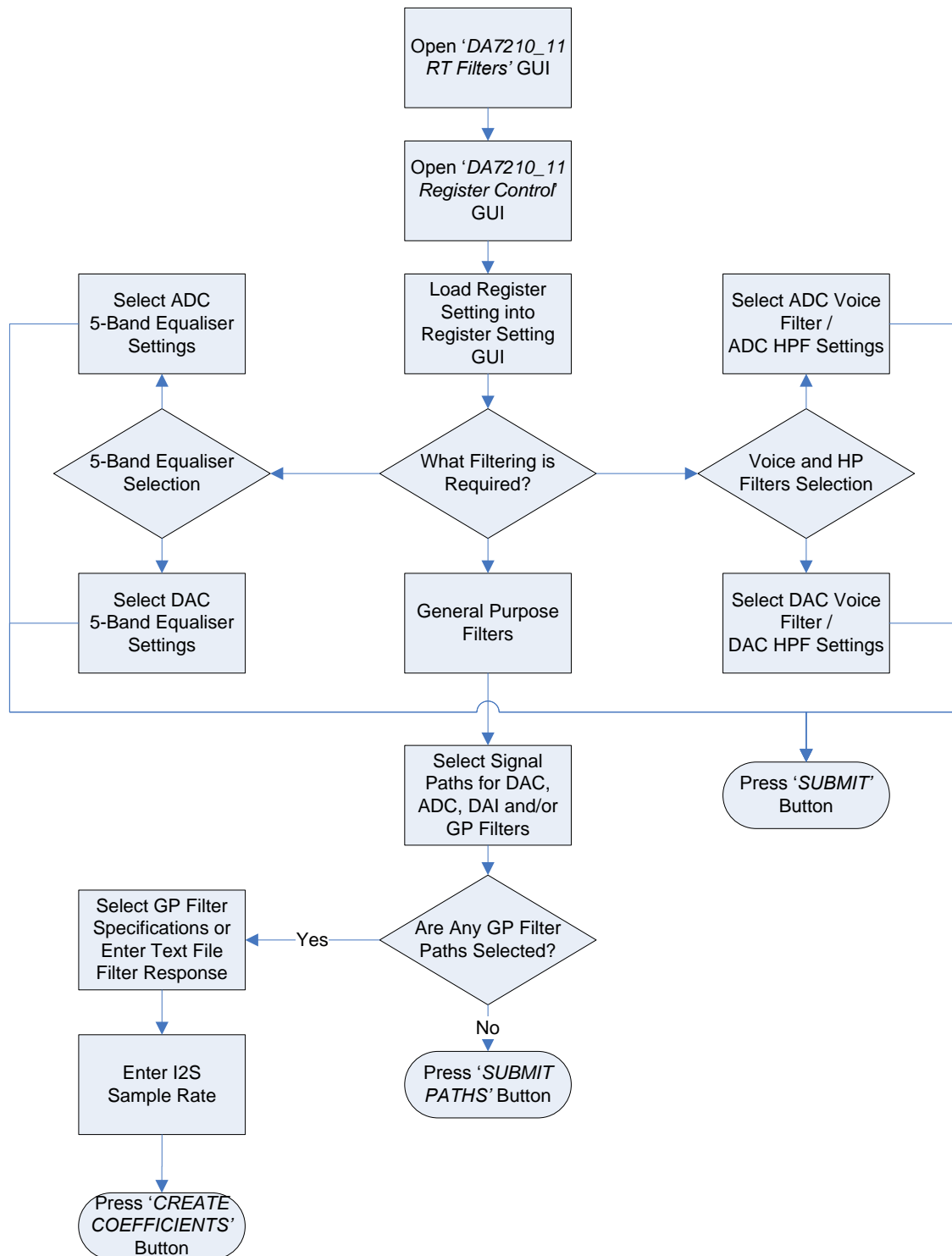

Figure 20 RT Filter Setup Flowchart

DA7210/11 USER MANUAL

5.3 Filter Setup Panel

The *Filter Setup* panel makes it possible to design desired filter responses through any of the general purpose filter banks, using the filter specification selections.

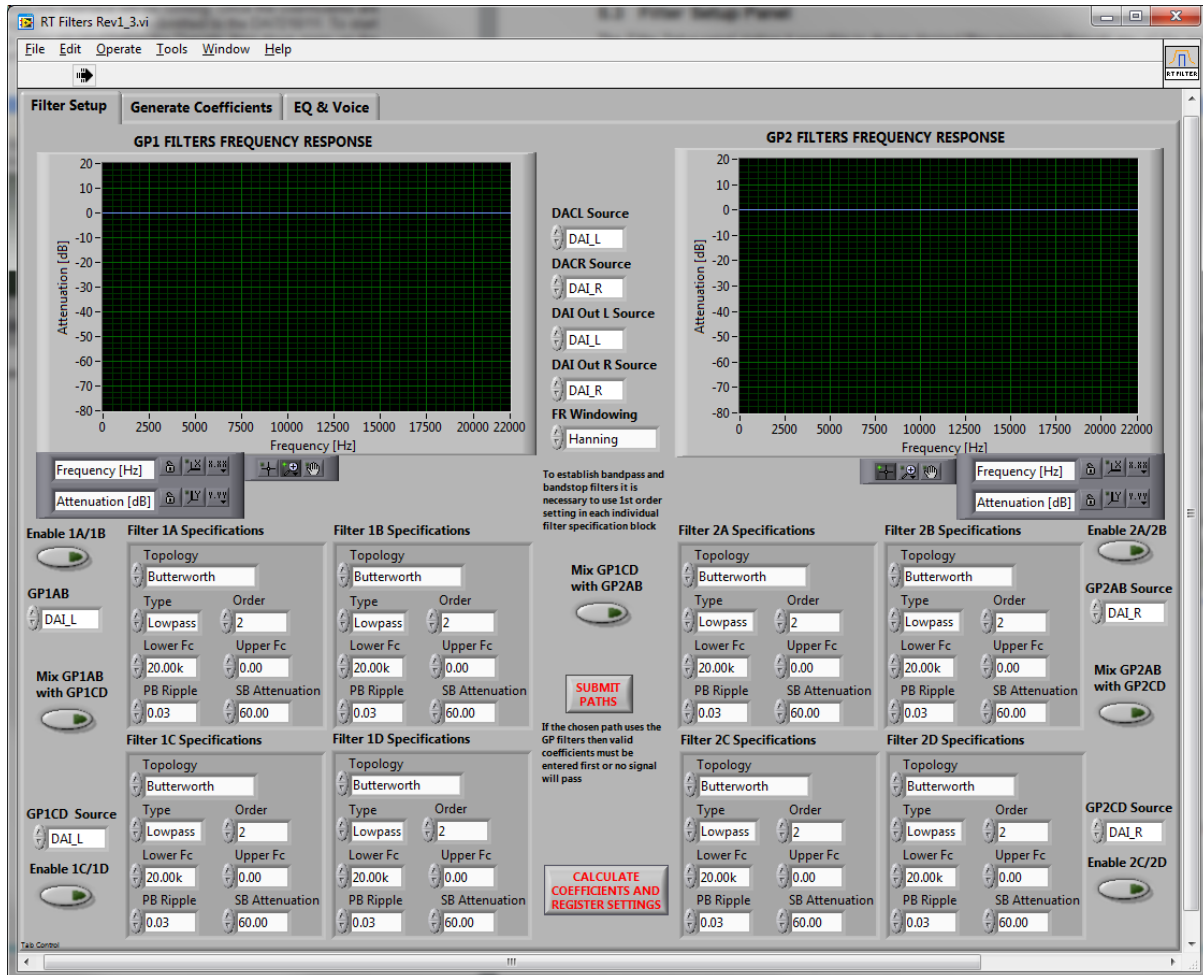

Figure 21 Filter Setup Panel

The *Filter Setup* panel controls the following realtime filter path selections:

- DACL and DACR input sources
- Enabling GP1AB, GP1CD, GP2AB and/or GP2CD
- GP1AB, GP1CD, GP2AB and GP2CD input sources
- Mixing of GP1AB and GP1CD, GP1CD and GP1CD or GP2AB and GP2CD

For each of the filter specifications blocks the following settings are available:

- Topology – Butterworth, Chebyshev, Inverse Chebyshev, Elliptic, Bessel
- Type – lowpass, highpass, bandpass, bandstop
- Order – order 2 should be used lowpass and highpass filters and order 1 for bandpass and bandstop filters only
- Lower Fc – lower frequency cut-off
- Upper Fc – upper frequency cut-off
- PB Ripple – passband ripple level
- SB attenuation – sideband attenuation level

DA7210/11 USER MANUAL

Pressing the *Submit Paths* button allows real-time selection of the filter path set-up while the interface is running.

The resultant coefficients from the selected filter responses can be calculated and submitted to the DA7210/11 by pressing the *Calculate Coefficients and Register Settings* button. The coefficients sent to the DA7210/11 are displayed on the *Coefficients* panel.

Important: Be aware that if any of the general purpose filter paths are selected and no coefficients have been entered, then the DA7210/11 will be unable to pass the signal to the selected output.

5.4 Coefficients Tab

The *Generate Coefficients* panel displays the forward and reverse coefficients for all of the general purpose filters and lists the register writes submitted to the DA7210/11. Here it is also necessary to enter the sample rate of the digital audio interface, so that the correct coefficient values are created; failure to do so will result either in zero entries or incorrect coefficient values.

The *Calculate Coefficients and Register Settings* button will perform the same action as the button of the same name on the *Filter Setup* panel.

The forward and reverse coefficients can be saved to file by selecting *Output Coefficients* button and by selecting a valid output file path. The spreadsheet file must already exist for the register values to be output.

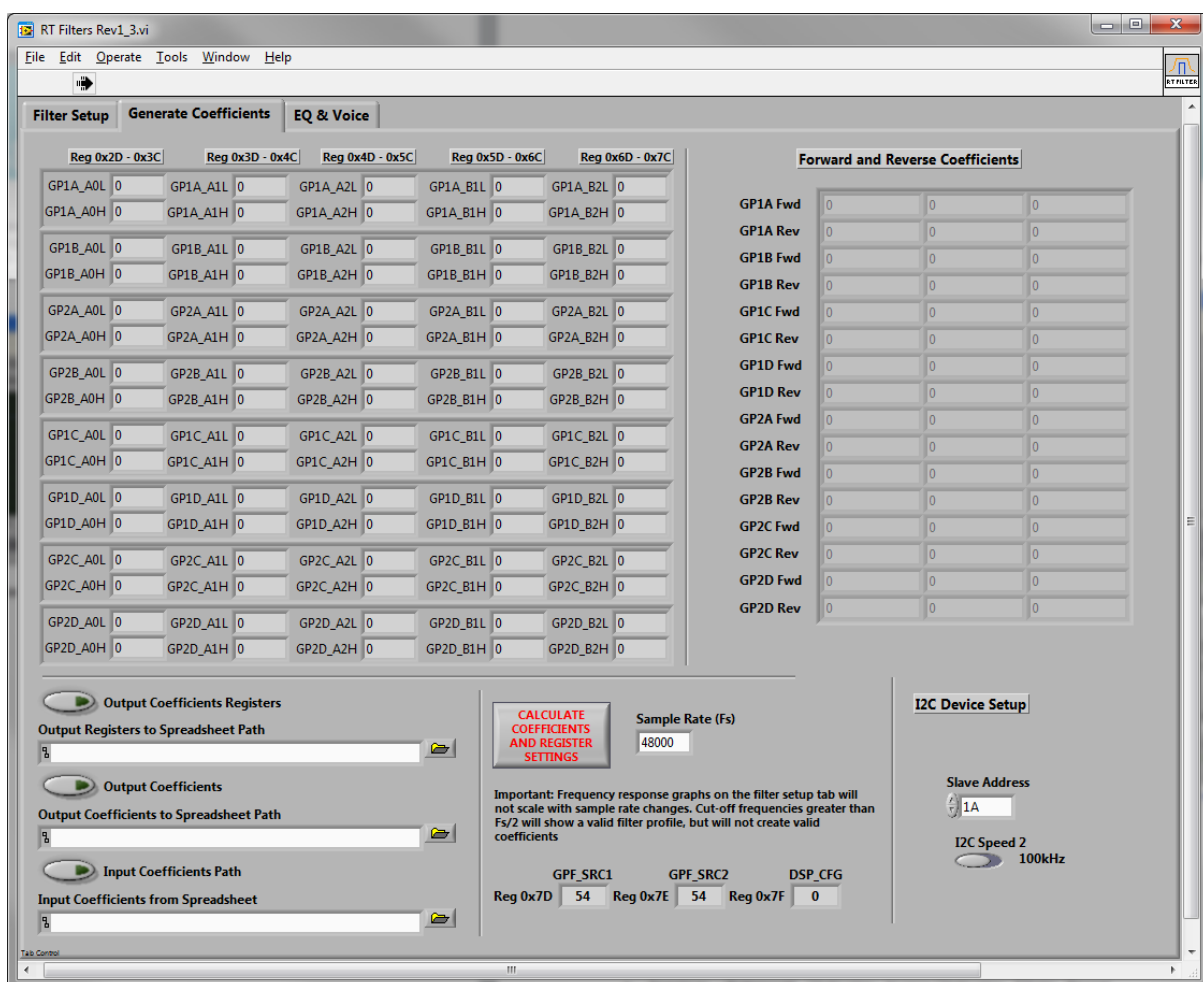
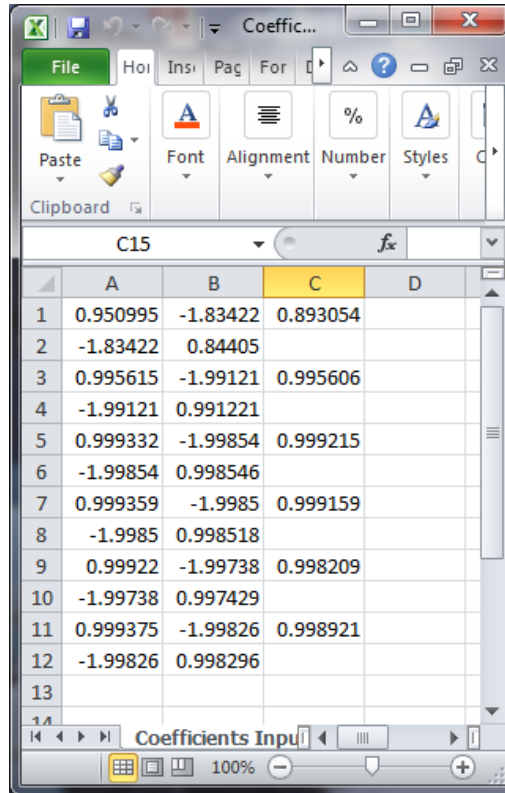

Figure 22 Coefficients Panel

DA7210/11 USER MANUAL

It is also possible to input coefficients to the device from spreadsheet by selecting *Input Coefficients* button and by selecting a valid input file path. Three forward and two reverse coefficients are required, an example is found in Figure 23.



	A	B	C	D
1	0.950995	-1.83422	0.893054	
2	-1.83422	0.84405		
3	0.995615	-1.99121	0.995606	
4	-1.99121	0.991221		
5	0.999332	-1.99854	0.999215	
6	-1.99854	0.998546		
7	0.999359	-1.9985	0.999159	
8	-1.9985	0.998518		
9	0.99922	-1.99738	0.998209	
10	-1.99738	0.997429		
11	0.999375	-1.99826	0.998921	
12	-1.99826	0.998296		
13				
14				

Figure 23 Input Coefficient Spreadsheet Example

Another facility on the *Generate Coefficients* panel allows the register values to be output to spreadsheet by selecting the *Output Coefficient Registers* button and by selecting a valid output file path. The spreadsheet file must already exist for the register values to be output.

The I2C device address and access speed can also be entered here.

DA7210/11 USER MANUAL

5.5 Five-band Equaliser and Voice Filter Panel

The *EQ & Voice* panel contains the controls for selection of the ADC and DAC five-band equalisers and for the voice filters. These registers can be submitted real-time while the interface is running by pressing the *Submit* button.

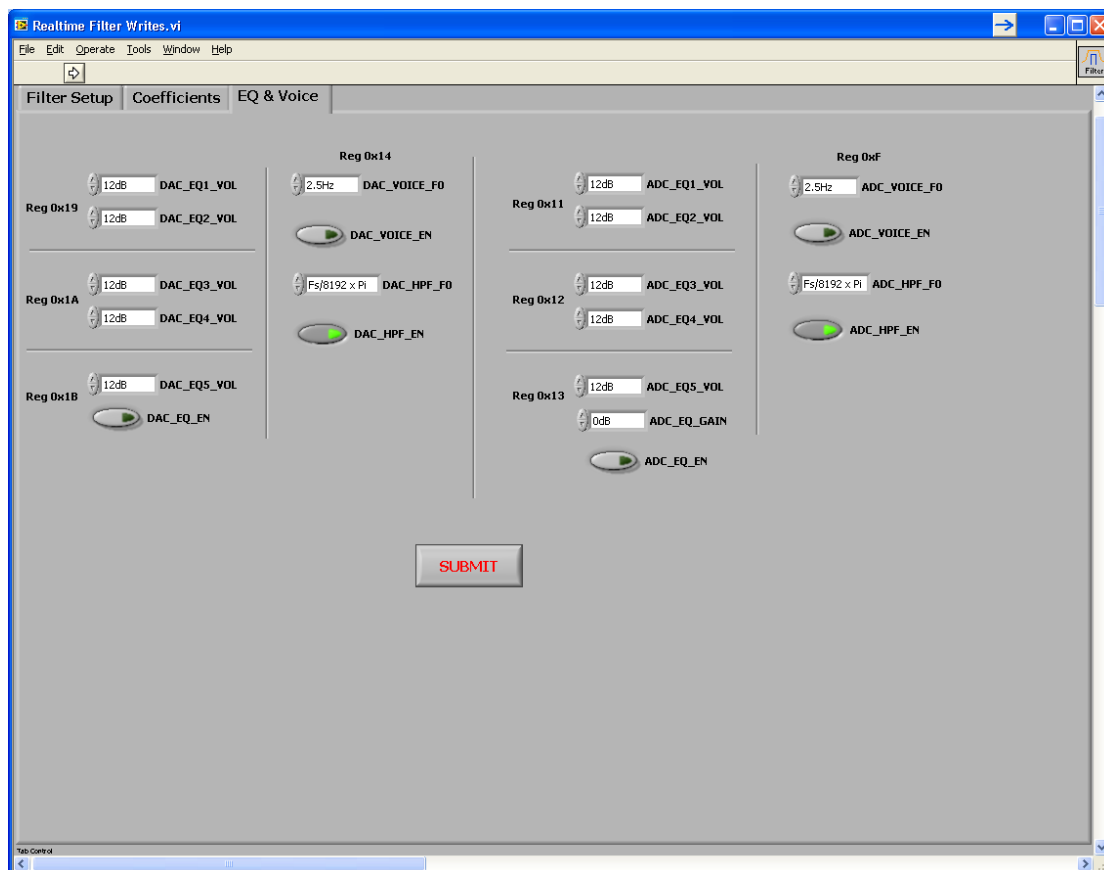

Figure 24 Five-band Equaliser and Voice Filter Panel

DA7210/11 USER MANUAL

Dialog Semiconductor worldwide offices

Germany (Headquarters)	Japan	Korea	Taiwan	USA	United Kingdom
Tel: (+49) 7021 805-0 Fax: (+49) 7021 805-100	Tel: (+81) 3 3769 8123 Fax: (+81) 3 3769 8124	Tel: (+82) 2 6007 2303 Fax: (+82) 2 6007 2001	Tel: (+886) 37 598 166 Fax: (+886) 37 595 026	Tel: (+1) 408 727 3200 Fax: (+1) 408 727 3205	Tel: (+44) 1793 757700 Fax: (+44) 1793 758000
Netherlands	China				
Tel: (+49) 7021 805-0 Fax: (+49) 7021 805-100	Tel: (+852) 2607 4271 Fax: (+852) 2607 4169				

Email: enquiry@diasemi.com

Web: www.dialog-semiconductor.com

This publication is issued to provide outline information only, which (unless agreed by Dialog Semiconductor in writing) may not be used, applied or reproduced for any purpose or form part of any order or contract or be regarded as a representation relating to products or services concerned. Dialog Semiconductor reserves the right to alter without notice the specification, design, price or conditions of supply of the product. Customer takes note that Dialog Semiconductor's products are not designed for use in devices or systems intended for supporting or monitoring life nor for surgical implants into the body. Customer shall notify the company of any such intended use so that Dialog Semiconductor may determine suitability. Customer agrees to indemnify Dialog Semiconductor for all damages that may be incurred due to use without the company's prior written permission of products in such applications.