

BK PRECISION®

Model: 4075B, 4076B, 4077B, 4078B, 4079B, 4080B

Arbitrary/Function Waveform Generator

USER MANUAL

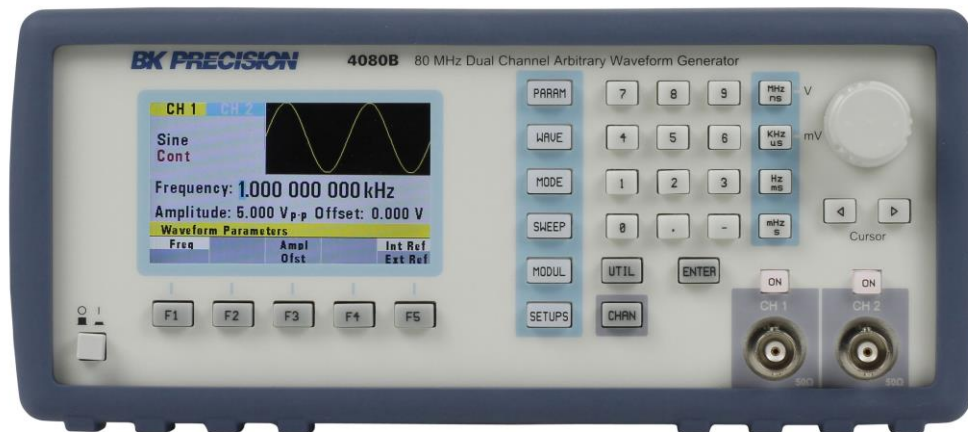

Safety Summary

The following safety precautions apply to both operating and maintenance personnel and must be followed during all phases of operation, service, and repair of this instrument.

WARNING

Before applying power to this instrument:

- Read and understand the safety and operational information in this manual.
- Apply all the listed safety precautions.
- Verify that the voltage selector at the line power cord input is set to the correct line voltage. Operating the instrument at an incorrect line voltage will void the warranty.
- Make all connections to the instrument before applying power.
- Do not operate the instrument in ways not specified by this manual or by B&K Precision.

Failure to comply with these precautions or with warnings elsewhere in this manual violates the safety standards of design, manufacture, and intended use of the instrument. B&K Precision assumes no liability for a customer's failure to comply with these requirements.

Category rating

The IEC 61010 standard defines safety category ratings that specify the amount of electrical energy available and the voltage impulses that may occur on electrical conductors associated with these category ratings. The category rating is a Roman numeral of I, II, III, or IV. This rating is also accompanied by a maximum voltage of the circuit to be tested, which defines the voltage impulses expected and required insulation clearances. These categories are:

Category I (CAT I): Measurement instruments whose measurement inputs are not intended to be connected to the mains supply. The voltages in the environment are typically derived from a limited-energy transformer or a battery.

Category II (CAT II): Measurement instruments whose measurement inputs are meant to be connected to the mains supply at a standard wall outlet or similar sources. Example measurement environments are portable tools and household appliances.

Category III (CAT III): Measurement instruments whose measurement inputs are meant to be connected to the mains installation of a building. Examples are measurements inside a building's circuit breaker panel or the wiring of permanently-installed motors.

Category IV (CAT IV): Measurement instruments whose measurement inputs are meant to be connected to the primary power entering a building or other outdoor wiring.

WARNING

Do not use this instrument in an electrical environment with a higher category rating than what is specified in this manual for this instrument.

⚠ WARNING

You must ensure that each accessory you use with this instrument has a category rating equal to or higher than the instrument's category rating to maintain the instrument's category rating. Failure to do so will lower the category rating of the measuring system.

Electrical Power

This instrument is intended to be powered from a CATEGORY II mains power environment. The mains power should be 120 V RMS or 240 V RMS. Use only the power cord supplied with the instrument and ensure it is appropriate for your country of use.

Ground the Instrument

⚠ WARNING

To minimize shock hazard, the instrument chassis and cabinet must be connected to an electrical safety ground. This instrument is grounded through the ground conductor of the supplied, three-conductor AC line power cable. The power cable must be plugged into an approved three-conductor electrical outlet. The power jack and mating plug of the power cable meet IEC safety standards.

⚠ WARNING

Do not alter or defeat the ground connection. Without the safety ground connection, all accessible conductive parts (including control knobs) may provide an electric shock. Failure to use a properly-grounded approved outlet and the recommended three-conductor AC line power cable may result in injury or death.

⚠ WARNING

Unless otherwise stated, a ground connection on the instrument's front or rear panel is for a reference of potential only and is not to be used as a safety ground.

Do not operate in an explosive or flammable atmosphere

⚠ WARNING

Do not operate the instrument in the presence of flammable gases or vapors, fumes, or finely-divided

particulates.

WARNING

The instrument is designed to be used in office-type indoor environments. Do not operate the instrument

- In the presence of noxious, corrosive, or flammable fumes, gases, vapors, chemicals, or finely-divided particulates.
- In relative humidity conditions outside the instrument's specifications.
- In environments where there is a danger of any liquid being spilled on the instrument or where any liquid can condense on the instrument.
- In air temperatures exceeding the specified operating temperatures.
- In atmospheric pressures outside the specified altitude limits or where the surrounding gas is not air.
- In environments with restricted cooling air flow, even if the air temperatures are within specifications.
- In direct sunlight.

CAUTION

This instrument is intended to be used in an indoor pollution degree 2 environment. The operating temperature range is 0 °C to 50 °C and the operating humidity is ≤ 95 % relative humidity at < 30 °C, with no condensation allowed.

Measurements made by this instrument may be outside specifications if the instrument is used in non-office-type environments. Such environments may include rapid temperature or humidity changes, sunlight, vibration and/or mechanical shocks, acoustic noise, electrical noise, strong electric fields, or strong magnetic fields.

Do not operate instrument if damaged

WARNING

If the instrument is damaged, appears to be damaged, or if any liquid, chemical, or other material gets on or inside the instrument, remove the instrument's power cord, remove the instrument from service, label it as not to be operated, and return the instrument to B&K Precision for repair. Notify B&K Precision of the nature of any contamination of the instrument.

Clean the instrument only as instructed

WARNING

Do not clean the instrument, its switches, or its terminals with contact cleaners, abrasives, lubricants, solvents, acids/bases, or other such chemicals. Clean the instrument only with a clean dry lint-free cloth or as instructed in this manual.

Not for critical applications

⚠ WARNING

This instrument is not authorized for use in contact with the human body or for use as a component in a life-support device or system.

Do not touch live circuits

⚠ WARNING

Instrument covers must not be removed by operating personnel. Component replacement and internal adjustments must be made by qualified service-trained maintenance personnel who are aware of the hazards involved when the instrument's covers and shields are removed. Under certain conditions, even with the power cord removed, dangerous voltages may exist when the covers are removed. To avoid injuries, always disconnect the power cord from the instrument, disconnect all other connections (for example, test leads, computer interface cables, etc.), discharge all circuits, and verify there are no hazardous voltages present on any conductors by measurements with a properly-operating voltage-sensing device before touching any internal parts. Verify the voltage-sensing device is working properly before and after making the measurements by testing with known-operating voltage sources and test for both DC and AC voltages. Do not attempt any service or adjustment unless another person capable of rendering first aid and resuscitation is present.

Do not insert any object into an instrument's ventilation openings or other openings.

⚠ WARNING

Hazardous voltages may be present in unexpected locations in circuitry being tested when a fault condition in the circuit exists.

Fuse replacement

⚠ WARNING

Fuse replacement must be done by qualified service-trained maintenance personnel who are aware of the instrument's fuse requirements and safe replacement procedures. Disconnect the instrument from the power line before replacing fuses. Replace fuses only with new fuses of the fuse types, voltage ratings, and current ratings specified in this manual or on the back of the instrument. Failure to do so may damage the instrument, lead to a safety hazard, or cause a fire. Failure to use the

specified fuses will void the warranty.

Servicing



Do not substitute parts that are not approved by B&K Precision or modify this instrument. Return the instrument to B&K Precision for service and repair to ensure that safety and performance features are maintained.

Cooling fans



This instrument contains one or more cooling fans. For continued safe operation of the instrument, the air inlet and exhaust openings for these fans must not be blocked nor must accumulated dust or other debris be allowed to reduce air flow. Maintain at least 25 mm clearance around the sides of the instrument that contain air inlet and exhaust ports. If mounted in a rack, position power devices in the rack above the instrument to minimize instrument heating while rack mounted. Do not continue to operate the instrument if you cannot verify the fan is operating (note some fans may have intermittent duty cycles). Do not insert any object into the fan's inlet or outlet.

For continued safe use of the instrument

- Do not place heavy objects on the instrument.
- Do not obstruct cooling air flow to the instrument.
- Do not place a hot soldering iron on the instrument.
- Do not pull the instrument with the power cord, connected probe, or connected test lead.
- Do not move the instrument when a probe is connected to a circuit being tested.

Compliance Statements

Disposal of Old Electrical & Electronic Equipment (Applicable in the European Union and other European countries with separate collection systems)

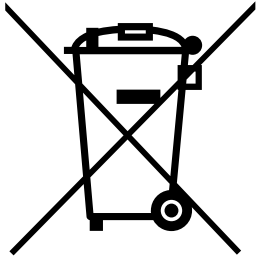

This product is subject to Directive 2002/96/EC of the European Parliament and the Council of the European Union on waste electrical and electronic equipment (WEEE), and in jurisdictions adopting that Directive, is marked as being put on the market after August 13, 2005, and should not be disposed of as unsorted municipal waste. Please utilize your local WEEE collection facilities in the disposition of this product and otherwise observe all applicable requirements.

CE Declaration of Conformity

This instrument meets the requirements of 2006/95/EC Low Voltage Directive and 2004/108/EC Electromagnetic Compatibility Directive with the following standards.











Low Voltage Directive

- EN61010-1: 2001

EMC Directive

- EN 61000-3-2: 2006
- EN 61000-3-3: 1995+A1: 2001+A2: 2005
- EN 61000-4-2 / -3 / -4 / -5 / -6 / -11
- EN 61326-1: 2006

Safety Symbols

	Refer to the user manual for warning information to avoid hazard or personal injury and prevent damage to instrument.
	Electric Shock hazard
	Alternating current (AC)
	Chassis (earth ground) symbol.
	Ground terminal
	On (Power). This is the In position of the power switch when instrument is ON.
	Off (Power). This is the Out position of the power switch when instrument is OFF.
	Power Switch (On/Off). This is the power switch located in front of the instrument.
	CAUTION indicates a hazardous situation which, if not avoided, will result in minor or moderate injury
	WARNING indicates a hazardous situation which, if not avoided, could result in death or serious injury
	DANGER indicates a hazardous situation which, if not avoided, will result in death or serious injury.

Contents

Safety Summary	i
Compliance Statements.....	vi
Safety Symbols.....	viii
1 General Information	1
1.1 Product Overview.....	1
1.2 Package Contents	1
1.3 Front Panel Overview	2
<i>Front Panel Description</i>	2
1.4 Rear Panel Overview	3
<i>Rear Panel Description</i>	3
1.5 Display Overview	4
<i>Display Description</i>	4
2 Getting Started	4
2.1 Input Power Requirements	5
<i>Input Power</i>	5
2.2 Output Connections	5
<i>Impedance Matching</i>	6
2.3 Preliminary Check.....	6
<i>Output Check</i>	6
3 Operating Instructions	7
3.1 Menu Keys	7
<i>Menu Tree</i>	7
<i>PARAMETER Key</i>	10
<i>WAVEFORM Key</i>	12
<i>PULSE Menu</i>	18
<i>MODE Key</i>	18
<i>SWEEP Key</i>	20
<i>MODULATION Key</i>	21
<i>SETUPS Key</i>	23
<i>UTILITY Key</i>	25
3.2 ON Key.....	26

3.3	Cursor Movement Keys	26
3.4	Rotary Input Knob	26
3.5	Power-On Settings.....	26
3.6	Memory.....	27
3.7	Displaying Errors.....	28
3.8	Creating an Arbitrary Waveform	29
	<i>Entering Individual Data Points</i>	29
	<i>Creating a Complex Arbitrary Waveform</i>	30
	<i>Setting the Frequency</i>	32
	<i>Setting the Amplitude</i>	33
	<i>Loading an Arbitrary Waveform</i>	33
3.9	Remote Interface.....	33
	<i>USB Interface</i>	33
	<i>GPIB Interface</i>	34
4	Programming	35
4.1	Overview	35
	<i>GPIB</i>	35
4.2	Device State.....	35
	<i>Local State (LOCS)</i>	35
	<i>Local With Lockout State (LWLS)</i>	35
	<i>Remote State (REMS)</i>	35
	<i>Remote With Lockout State (RWLS)</i>	35
4.3	Interface Function Subsets.....	35
4.4	Device Address	35
4.5	Message Exchange Protocol.....	36
	<i>The Input Buffer</i>	36
	<i>The Output Queue</i>	36
	<i>Response Messages</i>	36
	<i>Coupled Commands</i>	36
4.6	Block Data.....	37
4.7	Instrument Identification	38
4.8	Instrument Reset.....	38
4.9	Self-test	38
4.10	Command Syntax.....	38

	<i>General Command Structure</i>	38
	<i>SCPI Command Structure</i>	41
4.11	Status Reporting.....	43
	<i>The Status Byte</i>	43
	<i>Service Request Enabling</i>	43
	<i>Standard Event Status Register</i>	43
	<i>The Error Queue</i>	44
	<i>Error Codes</i>	44
4.12	Common Commands.....	48
	<i>System Data Commands</i>	48
	<i>Internal Operation Commands</i>	48
	<i>Synchronization Commands</i>	49
	<i>Status and Event Commands</i>	49
	<i>Device Trigger Commands</i>	51
	<i>Stored Settings Commands</i>	51
4.13	Instrument Control Commands.....	52
	<i>SOURce Subsystem</i>	52
	<i>OUTPut Subsystem</i>	68
	<i>Trigger Subsystem</i>	69
	<i>Arbitrary Subsystem</i>	71
	<i>Status Subsystem</i>	80
	<i>System Subsystem</i>	84
4.14	IEEE 488.1 Interface Messages.....	87
	<i>GET - Group Execute Trigger</i>	87
	<i>DCL - Device Clear</i>	87
	<i>SDC - Selected Device Clear</i>	87
	<i>LLO - Local Lockout</i>	87
4.15	SCPI Command Tree	88
	<i>Root Node</i>	88
	<i>:SOURce Subsystem</i>	88
	<i>:OUTPut Subsystem</i>	88
	<i>:TRIGger Subsystem</i>	89
	<i>:ARBitrary Subsystem</i>	89
	<i>:STATus Subsystem</i>	90

	<i>:SYSTEM Subsystem</i>	90
4.16	Block Transfer (GPIB only)	92
4.17	GPIB Communication Protocol.....	94
	<i>General</i>	94
	<i>Responses to IEEE-488.1 Interface Messages</i>	94
	<i>IEEE 488.2 Interface Function Subsets</i>	97
5	Troubleshooting Guide	98
6	Specifications	99
	SERVICE INFORMATION	103
	LIMITED THREE-YEAR WARRANTY	104

1 General Information

1.1 Product Overview

The B&K Precision 4075B series are versatile high performance arbitrary/function waveform generators capable of generating arbitrary waveforms with 14-bit resolution and length up to 16,000,000 points. In addition to the large waveform memory, these generators offer AM, FM, and FSK modulation along with sweep, burst, and flexible triggering capabilities. The instrument can be remotely operated via the USBTMC or GPIB (IEEE-488.2) interface supporting SCPI commands. Users can create arbitrary waveforms directly from the front panel using the generator's built-in waveform editing functions or load arbitrary waveforms via the instrument's remote interfaces.

Features:

- 14-bit, 200 MSa/s, and up to 16M points arbitrary waveform generator
- Generate Sine waveforms up to 80 MHz, Square waveforms up to 60 MHz
- Color LCD display
- AM, FM, and FSK modulation functions
- Fully programmable markers
- Store/recall up to 49 different instrument setups
- Standard USBTMC and GPIB (50 MHz/80 MHz models only) interfaces
- SCPI-compliant command set

1.2 Package Contents

Please inspect the instrument mechanically and electrically upon receiving it. Unpack all items from the shipping carton, and check for any obvious signs of physical damage that may have occurred during transportation. Report any damage to the shipping agent immediately. Save the original packing carton for possible future reshipment. Every instrument is shipped with the following contents:

- **1 x 4075B, 4076B, 4077B, 4078B, 4079B, or 4080B waveform generator**
- **1 x Full instruction manual on CD**
- **1 x AC power cord**
- **1 x USB type A to type B cable**
- **1 x Certificate of calibration**
- **1 x Test report**

Verify that all items above are included in the shipping container. If anything is missing, please contact B&K Precision.

1.3 Front Panel Overview

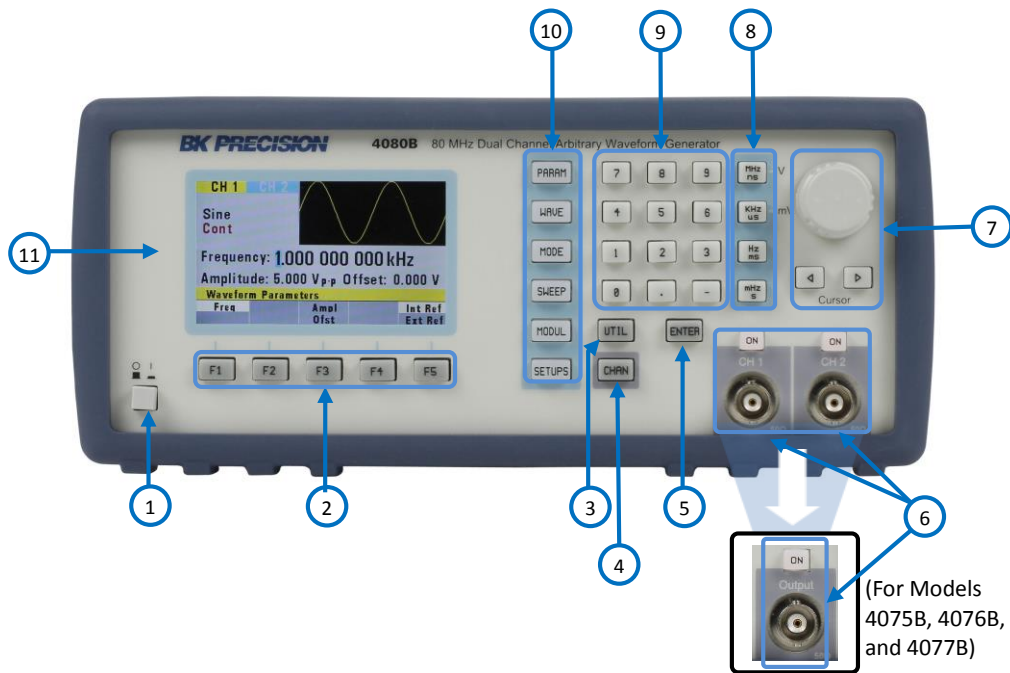

Figure 1.1 – Front Panel Overview

Front Panel Description

①	Power On/Off Switch
②	Function Keys (F1-F5)
③	UTILITY Key
④	CHANNEL Key (4078B, 4079B, and 4080B only)
⑤	ENTER Key
⑥	Channel Output BNC (50 Ω) and Enable
⑦	Rotary Knob and Cursor Keys
⑧	Unit Setting Keys
⑨	Numeric Keypad
⑩	Menu Option Keys
⑪	Color LCD Display Window

1.4 Rear Panel Overview

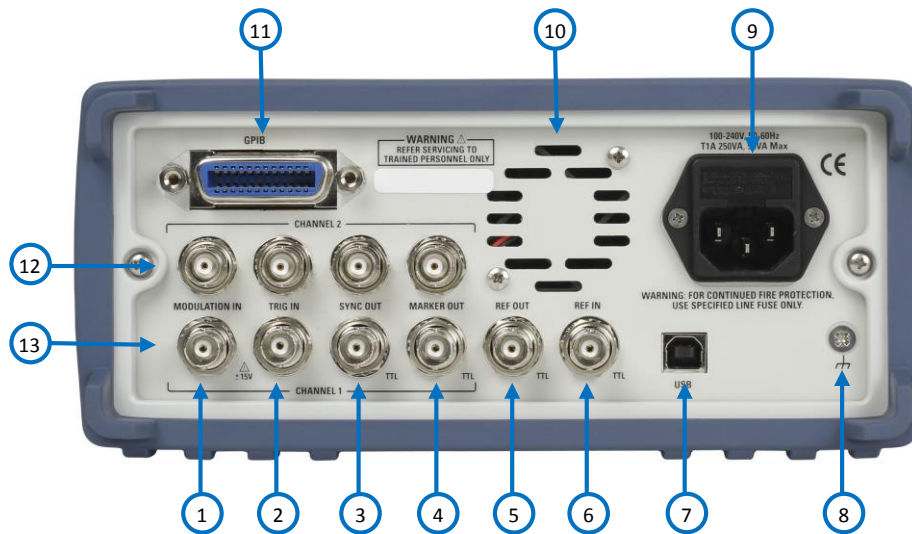

Figure 1.2 – Rear Panel Overview

Rear Panel Description

①	Modulation Input BNC
②	External Trigger Input BNC
③	Sync Output BNC
④	Marker Output BNC
⑤	10 MHz Reference Output BNC
⑥	10 MHz Reference Input BNC
⑦	USBTMC interface
⑧	Earth Ground
⑨	AC Power Connector and Fuse Box
⑩	Rear Cooling Fan
⑪	GPIB Port (4076B, 4077B, 4079B, and 4080B only)
⑫	Channel 2 I/O (4078B, 4079B, and 4080B only)
⑬	Channel 1 I/O

1.5 Display Overview

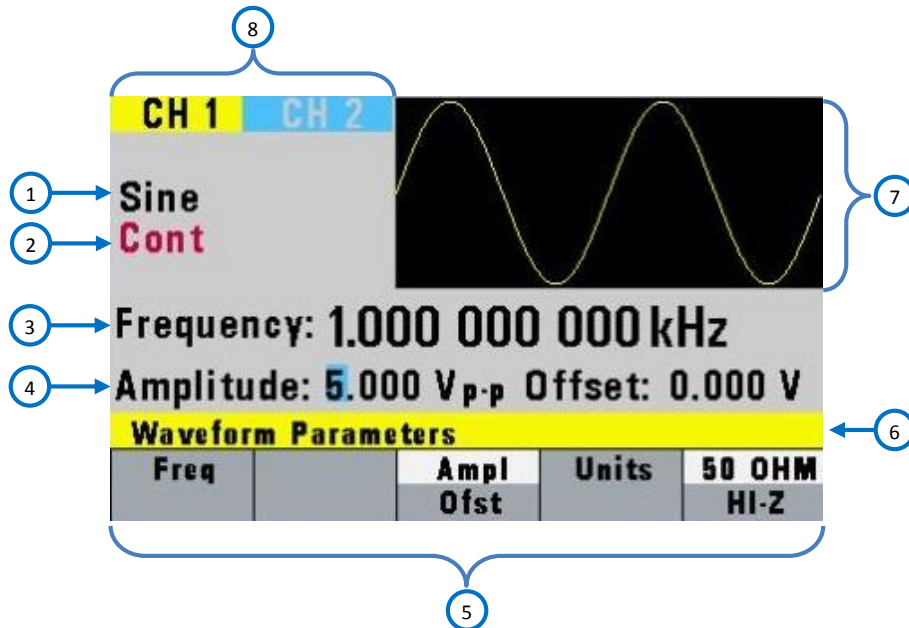

Figure 1.3 – Display Overview

Display Description

①	Wave Type
②	Trigger Mode
③	Frequency
④	Menu Parameters Values
⑤	Menu Options
⑥	Menu Title
⑦	General Waveform Display
⑧	Channel Selection Indicator

2 Getting Started

Before connecting and powering up the instrument, please review and go through the instructions in this chapter.

2.1 Input Power Requirements

Input Power

The instrument has a universal AC input that accepts line voltage and frequency input within:

100 – 240 V (+/- 10%), 50 – 60 Hz (+/- 5%)

Before connecting to an AC outlet or external power source, be sure that the power switch is in the OFF position and verify that the AC power cord, including the extension line, is compatible with the rated voltage/current and that there is sufficient circuit capacity for the power supply. Once verified, connect the cable firmly.

⚠ WARNING

The included AC power cord is safety certified for this instrument operating in rated range. To change a cable or add an extension cable, be sure that it can meet the required power ratings for this instrument. Any misuse with wrong or unsafe cables will void the warranty.

2.2 Output Connections

The waveform generator output circuits are protected against short circuit or nominal accidental voltages applied to the main output connector. The output circuits operate as a 50 Ω voltage source working into a 50 Ω load. At higher frequencies, a non-terminated or improperly terminated output may cause aberrations on the output waveform. In addition, loads with an impedance less than 50 Ω will reduce the waveform amplitude, while loads with an impedance greater than 50 Ω will increase waveform amplitude.

Excessive distortion or aberrations caused by improper termination are less noticeable at lower frequencies, especially with sine and triangle waveforms. To ensure waveform integrity, follow these precautions:

1. Use good quality 50 Ω coaxial cable and connectors.
2. Make all connections tight and as short as possible.
3. Use good quality attenuators, if it is necessary to reduce waveform amplitudes applied to sensitive circuits.
4. Use termination or impedance-matching devices to avoid reflections.
5. Ensure that attenuators and terminations have adequate power handling capabilities.

If there is a DC voltage across the output load, use a coupling capacitor in series with the load. The time constant of the coupling capacitor and load must be long enough to maintain pulse flatness.

Impedance Matching

If the waveform generator is driving a high impedance, such as a 1 M Ω input impedance (paralleled by a stated capacitance) of an oscilloscope vertical input, connect the transmission line to a 50 Ω attenuator, a 50 Ω termination and to the oscilloscope input. The attenuator isolates the input capacitance of the device and terminates the waveform generator properly.

2.3 Preliminary Check

Complete the following steps to verify that the generator is ready for use.

1. Verify AC Input Voltage

Verify and check to make sure proper AC voltages are available to power the instrument. The AC voltage range must meet the acceptable specification as explained in section 2.1.

2. Connect Power

Connect AC power cord to the AC receptacle in the rear panel and press the power switch to the ON position to turn ON the instrument. The instrument will have a boot screen while loading, after which the main screen will be displayed.

3. Self Adjust

At power-on, the waveform generator performs a diagnostic self-test procedure to check itself for errors. If it finds an error, an error code and text will appear in the display window. Other error codes appear when you enter an invalid front-panel setting. For more information on error codes, see the Displaying Errors section 3.7. When the waveform generator finishes the diagnostic self-test routine, it enters the local state (LOCS) and assumes power-on default settings.

Output Check

Follow the steps below to do a quick check of the settings and waveform output.

1. Turn on the instrument and set the instrument to default settings. To set to default, press **Setups**, press **Recall**, and select **0 Default Setup**. The instrument will set both channels with the following parameters:
Waveform Shape: **Sine**
Frequency: **1.000000000 kHz**
Amplitude: **5 .000 Vpp**
Offset: **0.000 Vdc**
Phase: **0.0 °**
Output Impedance: **50 OHM**
2. Connect the BNC output of CH1 into an oscilloscope.
3. Press the **On** button on top of CH1 output BNC to turn on the output and observe a sine wave with the parameters above.
4. Press the **Freq** option in the menu and use the rotary knob or the numeric keypad to change frequency. Observe the changes on the oscilloscope display.

5. Press the **Ampl** option in the menu and use the rotary knob or the numeric keypad to change the amplitude. Observe the changes on the oscilloscope display.
6. Press the **Offset** option in the menu and use the rotary knob or the numeric keypad to change the DC offset. With the oscilloscope set for DC coupling, observe the changes on the display.
7. Now, connect the BNC output of CH2 into an oscilloscope and follow steps 3 to 6 to check its output.

3 Operating Instructions

3.1 Menu Keys

These keys select the main menus for displaying or changing a parameter, function or mode. Below is the hierarchy and selections of the menu tree.

Menu Tree

- PARAM
 - FREQ | RATE (Arb Mode Only)
 - AMPL | OFST
 - UNITS (Only when AMPL is selected, press to toggle display in Vp-p, Vrms, dBm)
 - 50 OHM | HI-Z
 - INTCLK | EXTCLK
- WAVE
 - SINE
 - SQR (Duty Cycle)
 - TRI (Symmetry)
 - PULSE
 - FREQ | PERIOD
 - WIDTH
 - EQUAL EDGE
 - LEAD | TRAIL
 - PREV
 - ARB
 - START
 - LENGTH
 - MARK
 - ADDR
 - LENGTH
 - ON | OFF
 - PREV
 - EDIT
 - POINT

- ADRS
- DATA
- PREV
- LINE
 - FROM
 - TO
 - EXEC
 - NO
 - YES
 - PREV
 - PREV
- PREDEF
 - TYPE (Predefined Waveform Type)
 - FROM | DATA
 - LENG
 - SCALE (In %)
 - EXEC
 - NO
 - YES
 - PREV
 - EXEC (When NOISE is selected as TYPE)
 - ADD
 - NEW
 - EXEC
 - NO
 - YES
 - PREV
 - PREV
- MORE
 - COPY
 - FROM
 - LENG
 - TO
 - EXEC
 - NO
 - YES
 - PREV
 - PREV
 - CLEAR
 - FROM
 - TO
 - ALL
 - EXEC
 - NO
 - YES

- PREV
 - PREV
 - PROT
 - FROM
 - TO
 - ALL
 - ON | OFF
 - PREV
 - SHOW WAVE
 - PREV
 - PREV
 - PREV
- MODE
 - CONT
 - TRIG
 - MAN (Manual Trigger)
 - INT (Internal Trigger Rate)
 - EXT (External Trigger)
 - PREV
 - GATE
 - MAN (Manual Gate Trigger)
 - INT (Internal Gate Trigger Rate)
 - EXT (External Gate Trigger)
 - PREV
 - BURST
 - MAN (Manual Burst)
 - INT (Internal Burst Rate)
 - EXT (Burst External)
 - NBRST (Number of Bursts)
 - PREV
 - PHASE (Not available in ARB mode)
 - PHASE (Set Phase Degree)
 - SET-ZERO (Set Phase to 0)
 - SYNC Both Ch
 - PREV
 - SYNC Both Ch (ARB mode only)
- SWEEP (Not Available in PULSE and ARB mode)
 - ON | OFF
 - START (Sweep Start Frequency)
 - STOP (Sweep Stop Frequency)
 - RATE (Sweep Rate)
 - LIN | LOG | UP-DOWN (Linear or Logarithmic)
- MODUL
 - AM
 - ON | OFF
 - % (% of Modulation)

- SHAPE (AM Modulation Shape)
- MOD FREQ (AM Modulation Frequency)
- EXT | INT (External or Internal Modulation)
- FM (Not available in PULSE and ARB mode)
 - ON | OFF
 - DEV (FM Deviation Frequency)
 - SHAPE (FM Modulation Shape)
 - MOD FREQ (FM Modulation Frequency)
 - EXT | INT (External or Internal Modulation)
- FSK (Not available in PULSE and ARB mode)
 - ON | OFF
 - F-LO (FSK Low Frequency)
 - F-HI (FSK High Frequency)
 - RATE (FSK Rate)
 - EXT | INT (External or Internal modulation)
- SETUPS
 - RECALL (Recall Setup from Memory)
 - LOAD ARB (Loads arbitrary waveform. Available only in ARB mode)
 - STORE (Store Setup from Memory)
 - SAVE ARB (Saves current arbitrary waveform into memory. Available only in ARB mode)
- UTIL
 - GPIB (ACTIVE) (GPIB Address)
 - USB (ACTIVE)
 - POWER (Power On Setup)
 - SN (Serial number information)

PARAMETER Key

This key selects and displays the waveform frequency, amplitude, offset and external reference, and allows you to adjust the parameters. When Arbitrary Waveform is selected, the display also shows the point rate.

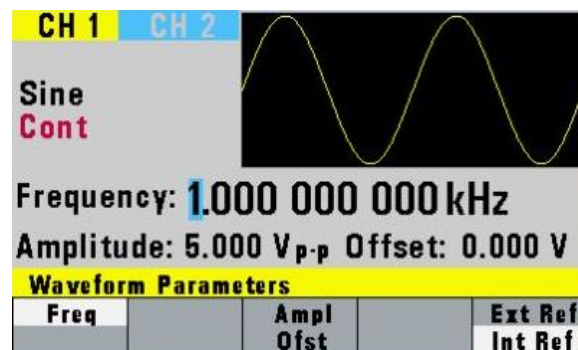

Figure 3.1 - Frequency Menu

F1: Freq/Rate - (Frequency) Selects and displays the frequency. Change the frequency setting using the cursor keys and rotary knob or numerical keypad. If a certain wavelength can't produce the waveform at the desired frequency, the waveform generator displays an "Out of Range" error message.

- (Rate) Selects and displays the Point Rate (for Arbitrary Waveform only). The Rate parameter governs the rate at which waveform points are executed, and thus the frequency of the waveform output. When you set this parameter, the waveform generator will keep that execution rate for all waveform lengths until it is changed.

F3: Ampl/Ofst

- Selects the Amplitude or the Offset parameters.
 - (Offset) Change the offset by using the cursor keys, rotary dial or numerical keypad. If a certain setting cannot be produced, the waveform generator will display a “Setting Conflict” message.

In Arbitrary mode, this setting defines the maximum peak-to-peak amplitude of a full-scale waveform. If the waveform does not use the full scale of data (-8191 to +8191), then its actual amplitude will be smaller.

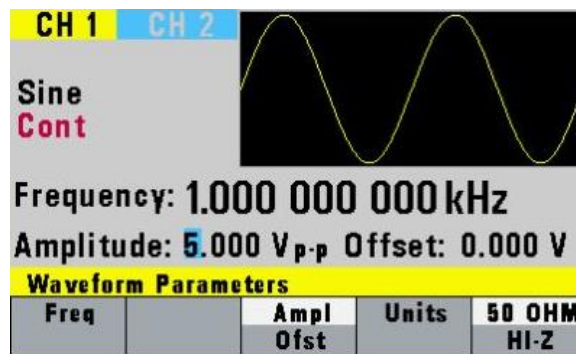

Figure 3.2 - Amplitude Menu

Setting the Amplitude

The following equation represents the relative output amplitude voltage relationship between the front-panel amplitude peak-to-peak setting and the data point values in waveform memory:

$$Output\ Voltage = \frac{Amplitude\ (Peak\ to\ Peak\ setting) \times data\ points\ value}{16382} + offset$$

Where 16382 is the total data point value range in waveform memory.

Examples

Table 3.1 - Output Voltage Examples

Front Panel Amplitude Setting	Data Point Value	Relative Output Amplitude Voltage
5 Vp-p	8191	+2.5 V
5 Vp-p	4095	+1.25 V
5 Vp-p	0	0V (offset voltage)

9 Vp-p	-4095	-4.5 V
4 Vp-p	-8191	-2 V

F4: Units - Selects the amplitude units: peak-to-peak, RMS or dBm (sine waves only).
Note: This option is shown when Ampl is selected.

F5: 50 OHM/HI-Z - Selects the amplitude voltage value based on the two different impedance termination (i.e. if connected to oscilloscope with 1MΩ input impedance, generator will display the correct amplitude value for 1MΩ termination when HI-Z is selected).
Note: This option is shown when Ampl/Ofst is selected.

F5: Int Ref/Ext Ref - Selects internal or external reference source (the external reference must be connected to the rear panel Ref In connector).
Note: This option is shown when Freq is selected.

WAVEFORM Key

Displays the waveforms available:

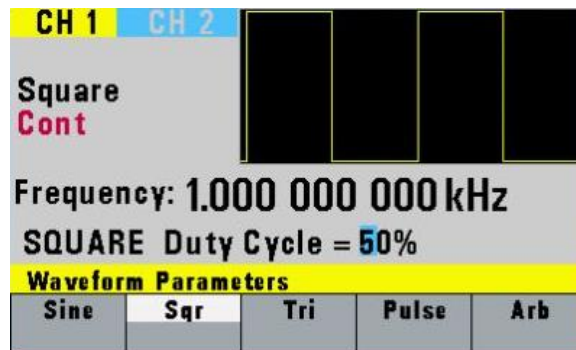

Figure 3.3 - Waveform Menu

F1: Sine - Selects the sine waveform.

F2: Sqr - Selects the square waveform and displays the waveform duty cycle that can be changed from 20% to 80% up to 10 MHz, 40% to 60% up to 30 MHz.

F3: Tri - Selects the triangle waveform and displays the waveform duty cycle that can be changed from 0% to 100% up to 500 kHz, 10% to 90% up to 2 MHz, and 50% up to the max frequency. The triangle maximum frequency is 5 MHz.

F4: Pulse - Selects the Pulse waveform and then displays the pulse menu. Refer to the PULSE Menu section for details.

F5: ARB - Selects the arbitrary waveform and then displays the Arbitrary menu:

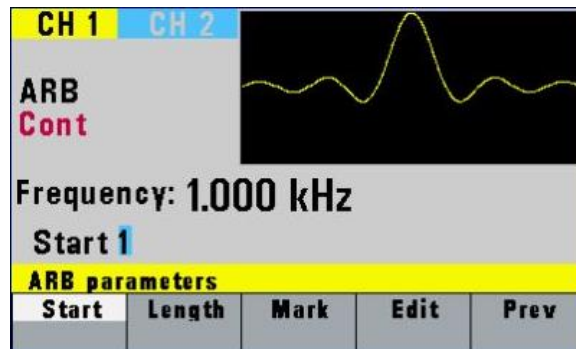

Figure 3.4 - Arbitrary Menu

- F1: Start** - Selects the starting address of the arbitrary waveform.
- F2: Length** - Selects the length of the arbitrary waveform. Use the START and LENGTH menu selection to mark a selection of the waveform memory that will be executed.
Note: The maximum Length allowed depends on model.
- F3: Mark** - (Marker Output) Selects the marker output address of the signal to be available at the Marker Out connector. The F2: ADDR, F3: LENGTH or F4: ON/OFF can be selected and the Marker output signal can be available at every 4th location address between the start and stop addresses of the executed waveform, starting from address 1 (i.e. 1, 5, 9, 13, etc.). This marker output feature will allow you to generate a positive TTL level output signal at the points specified by address and length.
Note: The maximum Length allowed to be set for marker is 4000. Marker Length can be set at every 4th location address starting from 4 (i.e. 4, 8, 12, etc.)

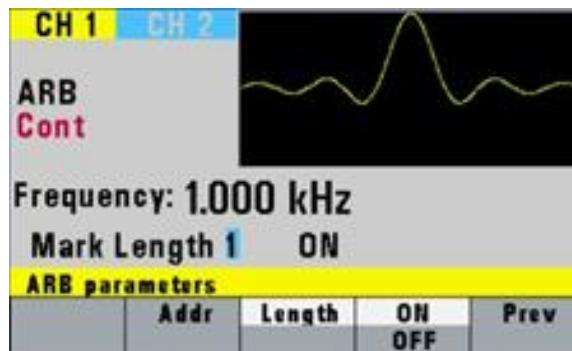
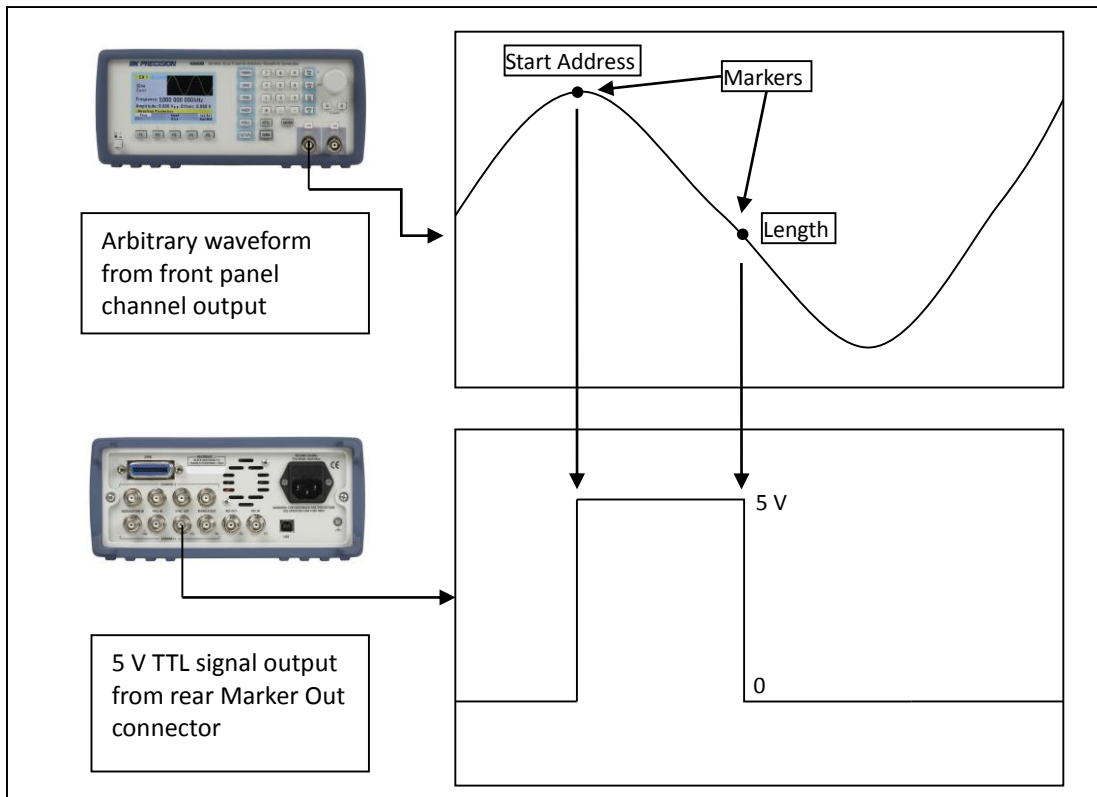

Figure 3.5 - Marker Menu

Below is an illustration of how the marker function works:



F4: Edit - Refer to the Arbitrary EDIT Menu section below for details.

F5: Prev - Back to previous menu.

Note: Changing one of the arbitrary parameters as start and length causes an update of the output waveform to the new parameters. When exiting the Arbitrary Menu by selecting a different waveform, a message to save the Arbitrary wave will be displayed. Select YES or NO to save the new waveform. This save functions the same as the SAVE ARB function.



Figure 3.6 - Arb Saving Menu

Arbitrary EDIT Menu

Enters data for creating arbitrary waveforms. You can enter data one point at a time, as a value at an address, draw a line from one point (a value at an address) to another point, create a predefined waveform, or combine these to create complex waveforms. The valid data values range is -8191 to 8191. The valid waveform memory addresses range from 1 to maximum memory length of instrument.

The data value governs the output amplitude of that point of the waveform, scaled to the instrument output amplitude. Therefore, a value of 8191 corresponds to positive peak amplitude, 0 corresponds to the waveform offset, and -8191 corresponds to the negative peak amplitude. The following menu displayed:

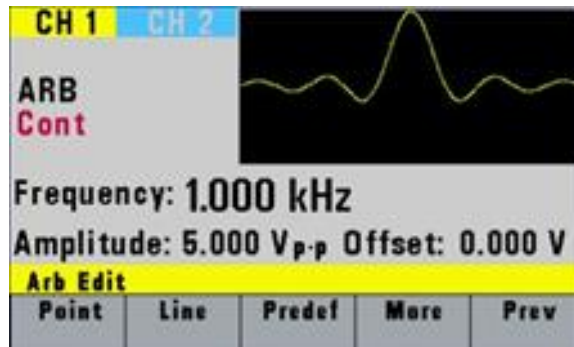

Figure 3.7 - Edit Menu

F1: Point - This menu allows point by point waveform editing. When selected, the following menu is displayed:

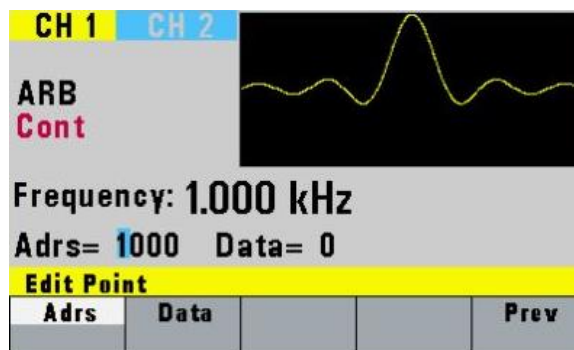

Figure 3.8 - Point Editing Menu

- F1: Adrs** - Select the current address in the arbitrary waveform memory.
- F2: Data** - Selects the data point value at the current address. You can change the point value from -8191 to 8191.
- F5: Prev** - Returns to the previous menu (Edit menu).

F2: Line - This menu allows a line drawing between two selected points. When selected, the following menu is displayed:

- F1: From** - Selects the starting point address.
- F2: To** - Selects the ending point address.
- F4: Prev** - Displays the Confirmation menu, **F1: NO** and **F3: YES**.
- F5: Prev** - Returns to the previous menu (Edit menu).

F3: Predef - (Predefined Waveforms) Selects one of the predefined waveforms.

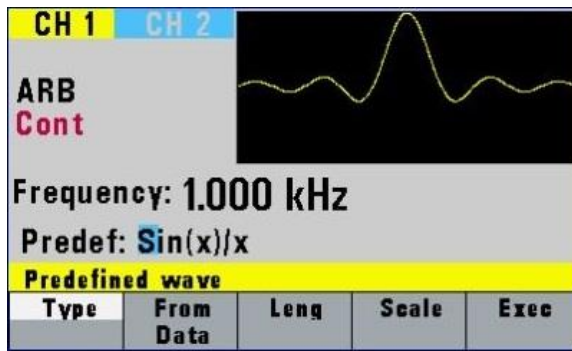

Figure 3.9 - Predefine Waveform Menu

F1: Type - Selects the waveform Sine, Triangle, Square, Noise, Ramp up, Ramp down, exponential up, exponential down, Sin(x)/x, and Gaussian distribution. If Noise function is selected, a submenu is displayed when **F5: EXEC** is pressed to allow adding the noise to an available waveform or to generate it as a new noise waveform.

F2: From/Data - Selects the starting point of the generated waveform and its data value.

F3: Leng - Selects the length of the predefined waveform (number of points for a full wave). The length value must be a number that is divisible by 4 or by 2 in some instances. If not, a pop up message will say “Must divide by 4” or “Must divide by 2” and entered values will change back to its original. Different waveforms have different limitations on the length. Refer to Table 3-2 below.

Table 3.2 - Waveform Length Limits for Predefined Waveforms

Wave	Minimum Length	Divisible by
Sine	16	4
Triangle	16	4
Square	2	2
Noise	16	1

F4: Scale - Selects the scale of the waveform. If scale is too high, a message will display “Scale too high.” 100% means that the waveform spans the full scale of -8191 to 8191. Scale factors are limited by the point data value of the starting point and automatically calculated by the unit.

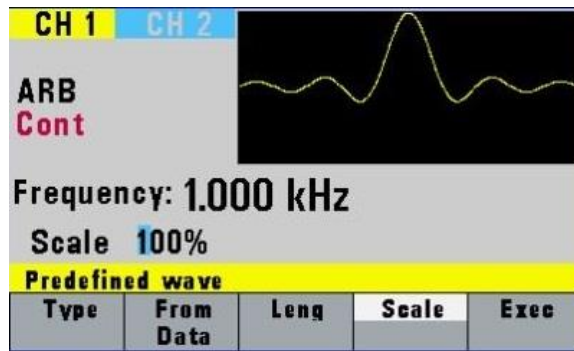

Figure 3.10 - Scale Menu

F5: Exec - Prompts you to confirm whether to execute the selected predefined waveform. Press NO to abort executing the predefined waveform; press YES to execute the predefined waveform. On the NOISE function a menu of ADD and NEW is prompted to select a new noise waveform or to add noise to the existing waveform.

F4: More - Displays the following Menu:

F1: Copy - Displays the Copy menu (see the Copy Function later in this section).

F2: Clear - Displays the Clear menu (see the Clear Function later in this section).

F3: Prot - Displays the Protect menu (see the Protect Function later in this section).

F4: Show Wave - Display the Arbitrary waveform in full screen mode on LCD display. This is only an approximated display for quick viewing. It does not represent the exact waveform being generated. To return back to the MENU selection, press any button.

F5: Prev - Returns to the previous menu.

Copy Function - Copies an area of waveform memory to another area of waveform memory.

F1: From - Selects the address of the first point to copy.

F2: Leng - Selects the length (number of points) of the waveform to copy.

F3: To - Selects the destination address where the first point is copied.

F4: Exec - Prompts to confirm to copy data. Press NO to abort copying, YES to copy.

F5: Prev - Returns to previous menu.

Clear Function - Clears (sets the data values to zero) either a section of or all of waveform memory.

F1: From - Selects the address of the first point to clear.

F2: To - Selects the address of the last point to clear.

F3: All - Clears the whole waveform memory.

F4: Exec - Prompts to confirm to clear data. Press NO to abort clearing, YES to clear.

F5: Prev - Returns to previous menu.

Protect Function - Protects (makes read-only) a section of waveform memory.

Note: Only one segment of waveform memory can be protected at a time.

F1: From - Selects the address of the first point to protect.

F2: To - Selects the address of the last point to protect.

F3: All - Clears the whole waveform memory.

F4: On/Off - Selects the unprotect mode and resets memory protection so that the whole waveform memory can be written into.

F5: Prev - Returns to previous menu.

PULSE Menu

From the **WAVE** menu, select **F4: Pulse**.

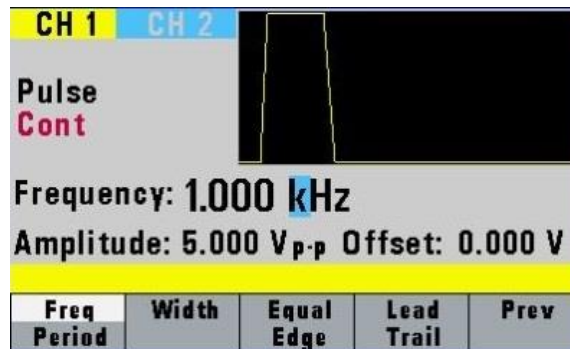

Figure 3.11 - Pulse Menu

F1: Freq/Period - Selects the parameter definition of the Pulse repetition period.

F2: Width - Selects the Width of the generated pulse.

F3: Equal Edge - Selects equal Rise (Leading edge) and Fall (Trailing edge) times of the pulse.

F4: Lead/Tail - Selects different Rise and Fall times of the Pulse.

F5: Prev - Returns to previous menu.

MODE Key

Selects the output mode: Cont (Continuous), Trig (Triggered), Gated (Gated), and Burst (Burst).

To select the output mode, press **MODE**, then press the function key that corresponds to the desired Mode menu option, as shown:

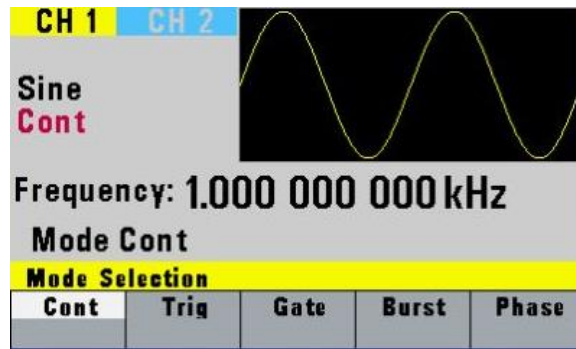

Figure 3.12 - Mode Menu

- F1: Cont** - (Continuous) - Selects continuous output.
- F2: Trig** - (Triggered) - Triggers one output cycle of the selected waveform for each trigger event.
- F3: Gate** - (Gate) - Triggers output cycles as long as the trigger source asserts the gate signal.
- F4: Burst** - (Burst) - Triggers output N output cycles for each trigger event, where N ranges from 2 to 999999.
- F5: Phase** - Selects the start phase of the signal in non-continuous modes. The range is from -180° to +180°, with a 0.1° resolution.

When Phase Menu is selected the following screen is displayed:

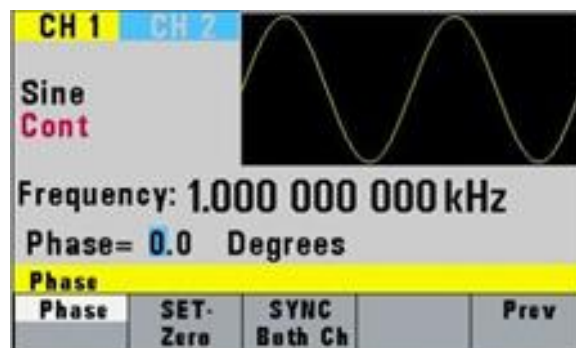

Figure 3.13 - Phase Menu

- F1: Phase** - Sets the phase.
- F2: SET-Zero** - Sets the phase reference to zero.
- F3: SYNC Both Ch.** - For Dual Channel models, pushing this key synchronizes both channels in between with a phase shift as in the Phase parameter entered (or 0 after pushing SET-Zero).

After selecting the TRIG, GATE or BURST menu, the trigger source menu is available:

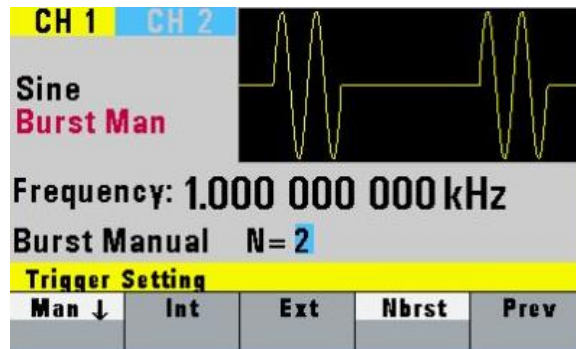

Figure 3.14 - Trigger Menu

- F1: Man** - Selects manual as the trigger source. To trigger the waveform generator, press this MAN TRIG again.
- F2: Int** - (Internal) Selects the internal trigger generator as the trigger source. Change the internal trigger rate displayed with the rotary input knob.
- F3: Ext** - (External) Selects the external trigger signal as the trigger source. The trigger source is supplied through the TRIG IN connector.
- F4: Nbrst** - In BURST mode, the F4 displays Nbrst, the number of burst pulses to be output with each trigger. The N can be changed from 1 to 999,999.
- F5: Prev** - (Previous) Returns to the previous Menu selection.

SWEEP Key

Selects the Sweep Mode and allows the entering of sweep parameters: Sweep Start, Sweep Stop, and Sweep Rate.

To select the sweep mode, press **SWEEP** and then press the function key that corresponds to the desired Sweep menu option as shown below.

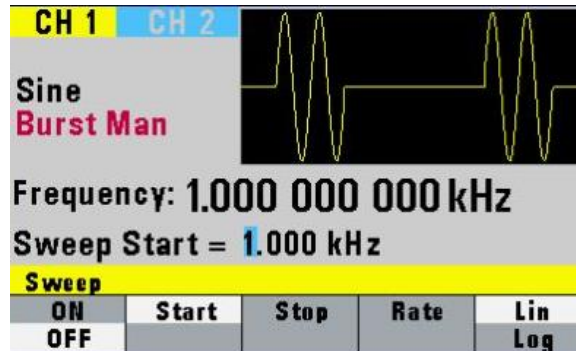

Figure 3.15 - Sweep Menu

- F1: ON/OFF** - Operates the sweep function, selecting between Sweep On or Off.

- F2: Start** - Defines the Sweep Start frequency.
- F3: Stop** - Defines the Sweep Stop frequency.
- F4: Rate** - Defines the Sweep Rate.
- F5: Lin/Log** - Selects Linear or Logarithmic Sweep.

How to Set up Sweep in Different Modes

By default, turning ON the sweep function will automatically set to a continuous (Cont) sweep. In order to change to other modes of sweep, do the following:

1. Set sweep to On by pressing F1.
2. Press the **MODE** button on the front panel.
3. Select between triggered (**Trig**), burst (**Burst**) or gated (**Gate**) mode.

Note: If this is done before turning on sweep, sweep On selection will automatically reset to default (continuous mode).

MODULATION Key

Selects the modulation mode **AM**, **FM**, or **FSK**.

To select the modulation mode, press **MODUL** key and then press the function key that corresponds to the desired menu option.

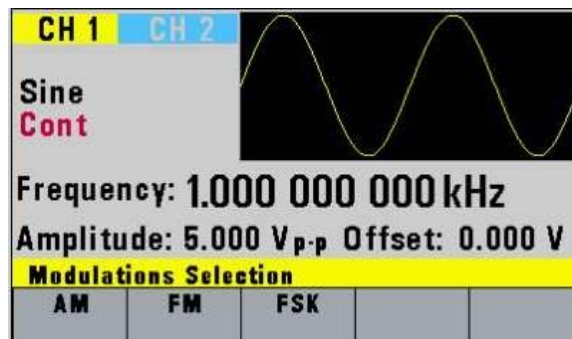

Figure 3.16 - Modulation Menu

- F1: AM** - If **AM** is selected, the following menu is available:

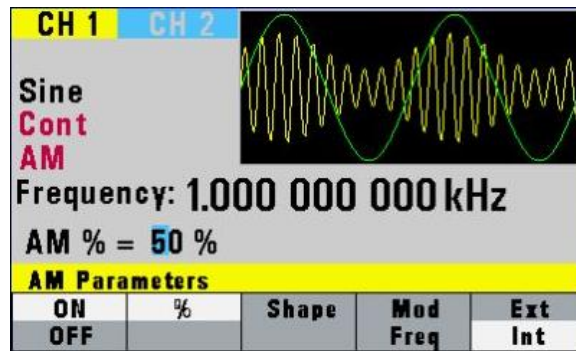

Figure 3.17 - AM Menu

- F1: ON/OFF** - Turns the modulation ON or OFF.
- F2: %** - Defines the AM modulation depth.
- F3: Shape** - Defines the modulation shape between Sine, Triangle or Square.
- F4: Mod/Freq** - Selects the modulation frequency, from 0.01 Hz to 20.00 KHz.
- F5: Ext/Int** - Selects and enables the external modulation by an external signal applied to the Modulation In connector.

F2: FM - If **FM** is selected, the following menu is available:

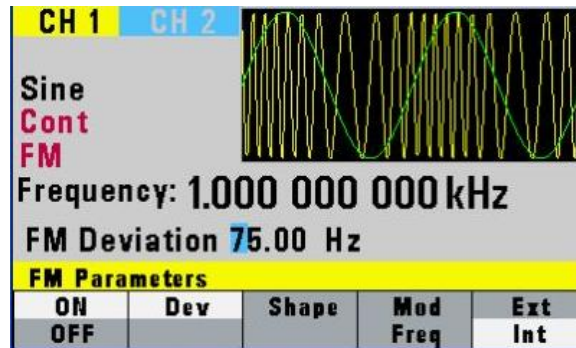

Figure 3.18 - FM Menu

- F1: ON/OFF** - Turns the modulation ON or OFF.
- F2: Dev** - Defines the FM deviation frequency.
Note: The deviation is < the frequency. Frequency + deviation is limited to the unit maximum frequency.
- F3: Shape** - Defines the modulation shape between Sine, Triangle or Square.
- F4: Mod/Freq** - Selects the modulation frequency, from 0.01 Hz to 20.00 KHz.
- F5: Ext/Int** - Selects and enables the external modulation by an external signal applied to the Modulation In connector.

F3: FSK - If **FSK** is selected, the following menu is available:

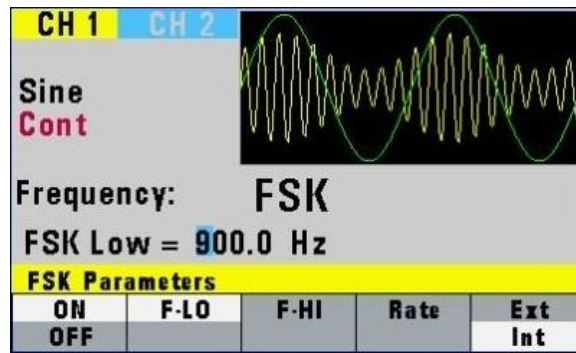

Figure 3.19 - FSK Menu

- F1: ON/OFF** - Turns the modulation ON or OFF.
- F2: F-LO** - Defines the low frequency of the FSK.
- F3: F-HI** - Defines the high frequency of the FSK.
- F4: Rate** - Selects the rate of the alternating between the low and high frequencies.
- F5: Ext/Int** - Selects and enables the external FSK when the unit frequency is alternating between the low and high frequencies by an external signal applied to the **Trig In** connector.

Modulation Combinations

	SINE	SQUARE	TRIANGLE	PULSE	ARBITRARY
AM	Yes	Yes	Yes	Yes	Yes
FM	Yes	Yes	Yes	No	No
FSK	Yes	Yes	Yes	No	No

SETUPS Key

The waveform generator can store the current front-panel settings, called a setup, into one of 50 storage locations. When you recall a setup, the waveform generator restores the front-panel settings to those that you stored in the selected storage location. All waveform data except for the waveform memory data is stored in the setup.

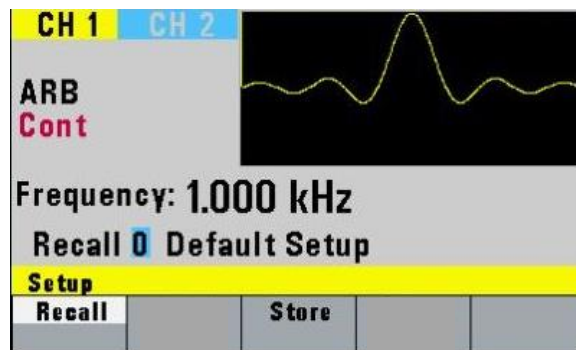

Figure 3.20 - Setups Menu

F1: Recall - Recalls a previously stored front-panel setup from the selected storage location. Change the storage location number by using the rotary input knob. Valid storage location numbers are from 0 to 49. Location 0 is a read-only buffer that contains the power-on settings listed in Table 3.3.

F3: Store - Stores the current front-panel setup to the specified storage location. Change the storage location number by using the numeric keypad or the rotary input knob. Valid storage location numbers range from 1 to 49. Below is a list of parameters that can be stored in each storage location.

Table 3.3 - List of Stored Parameters

Stored Parameters
FREQUENCY
RATE(ARB)
AMPLITUDE
FUNCTION
OFFSET
REPETITION
MODE
N-BURST
START ADRS
WAVELENGTH
TRIG SOURCE
OUTPUT
SWEEP
MODULATION

When the ARB waveform is selected, the setup menu is as shown:

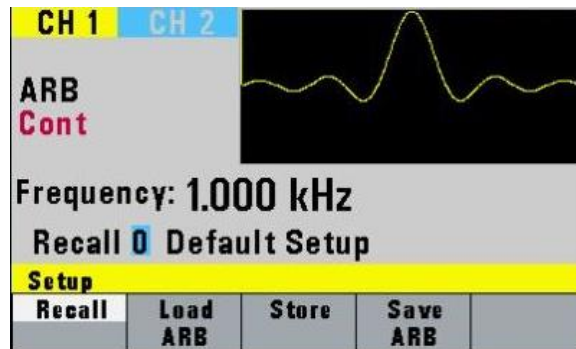

Figure 3.21 - Setups Menu (with Arbitrary waveform selected)

F2: Load ARB - Selecting this will load the selected Arbitrary waveform data points.

F4: Save ARB - Selecting this will save the current Arbitrary waveform data points so that it can be recalled when revisiting the ARB menu later on or when power cycling the instrument.

8 full-length waveforms can be saved per channel. The saving is performed only on the waveform segment that is defined by the Start and Length parameters defined in the ARB menu.

Note: Storing a waveform generator setup does not store waveform memory data.

The STORE and RECALL function can be used as a tool to store and locate many arbitrary waveforms. See [Memory](#) section for more information on segmenting arbitrary waveforms.

UTILITY Key

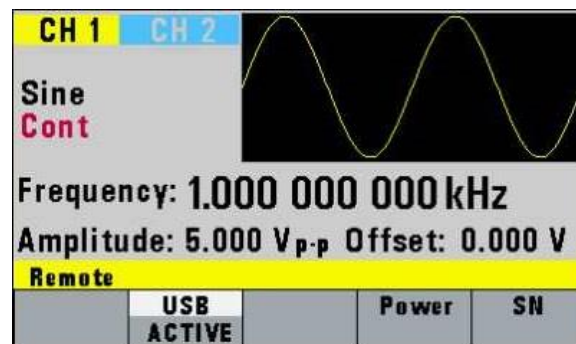

Figure 3.22 - Utility Menu

- F1: Gpib** - Selects the GPIB remote mode of operation. After selection, the GPIB address can be set to any value from 1 to 31 using the rotary knob. The value is kept in nonvolatile memory and used at power-on. The factory default address is 9. Setting the address to 31 puts the device in the off-bus state (it will not respond to messages on the GPIB bus).
Note: GPIB is only for models 4076B, 4077B, 4079B, and 4080B.
- F2: USB** - Selects the USB remote mode of operation. If selected, the **ACTIVE** message is displayed.
- F4: Power** - (Power-On default) Selects the power-on default setting. Select a value using the numeric keypad or the rotary input knob. The selection is effective after a 10 s time-out period. Select zero (0) to have the waveform generator power on with the factory default settings. Select 50 to have the waveform generator power-on with the settings it had at the last power-off. Select any other value in the range from 1 to 49 to have the waveform generator power-on with the settings that you have saved with STORE (see SETUPS Key section) in the range of 1 to 49.
- F5: SN** - Selecting this will display the serial number information of the unit.

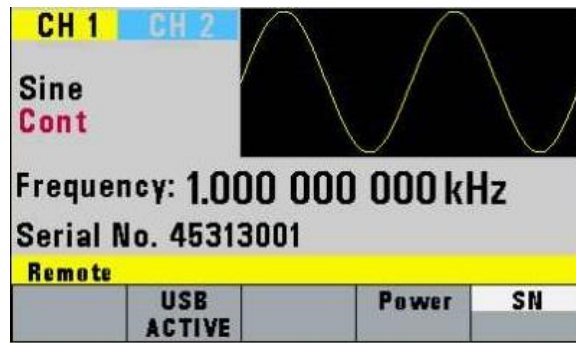

Figure 3.23 - Serial Number Information

3.2 ON Key

Use this key to control the main output signal. When the output is active, the **On** button is illuminated by the built-in LED.

3.3 Cursor Movement Keys

Use these keys to move the cursor (when visible) either left or right. They are used in conjunction with the rotary input knob to set the step size of the rotary input knob.

3.4 Rotary Input Knob

Use this knob to increase and decrease numeric values or to scroll through a list. The cursor indicates the low-order position of the displayed value which changes when you rotate the knob (for straight numeric entries only). For other types of data, the whole value changes when you rotate the knob.

3.5 Power-On Settings

At power-on, the waveform generator performs a diagnostic self-test procedure to check itself for errors. If it finds an error, an error code and text will appear in the display window. Other error codes appear when you enter an invalid front-panel setting. For more information on error codes, see the Displaying Errors section 3.7.

When the waveform generator finishes the diagnostic self-test routine, it enters the local state and assumes power-on default settings. Table 3.4 below lists the factory default settings. You can also program the waveform generator for any settings you want at power-on.

Table 3.4 - Power-On Default Settings

Key Functions	Values	Description
FREQUENCY	1.000000000 Hz	Wave frequency
RATE(ARB)	1 μ s	Sample time per point
AMPLITUDE	5.00 V	Peak to peak output amplitude
FUNCTION	SINE	Output waveform
OFFSET	0.00 V	Zero offset
REPETITION	10 ms	Internal trigger rate

MODE	CONT	Waveform mode
N-BURST	2	Waves per burst
START ADRS	1	Start memory address
WAVELENGTH	1000	Number of points per waveform
TRIG SOURCE	EXT	External trigger source
OUTPUT	OFF	Output disabled
SWEEP	OFF	Sweep execution
MODULATION	OFF	Modulation execution

3.6 Memory

The waveform generator has two types of memory that can be stored and recalled:

- Waveform Memory (8 waveforms per channel)
- Setup Memory (0-49 buffer storage locations)

Up to 8 full waveforms can be stored, each with up to the maximum waveform memory points available per channel.

	4075B	4078B	4076B	4079B	4077B	4080B
Channels	1	2	1	2	1	2
Waveform Memory Length	2 points to 1,048,576 points		2 points to 4,194,304 points		2 points to 16,777,216 points	

The user can edit arbitrary waveforms in waveform memory and specify any data value in the range from -8191 to 8191 for any point in waveform memory (14-bit depth). Due to the large memory bank, users have greater freedom in selecting the size and number of waveforms they desire to generate. The STORE and RECALL functions can be used to save the starting address and length of up to 49 different waveforms as reference point setups for quick recall.

Note: The 49 different setups are shared between all 8 arbitrary waveform memory banks. For instance, if Setup 1 is saved from address 1 to 1000 for ARB Wave 1, then ARB Wave 2 is selected and Setup 1 is recalled, address 1 to 1000 will be the recalled reference points.

Waveform Memory setup example:

4080B users could segment one 16,777,216-point arbitrary waveform bank to create a waveform with 1 Mpts, another waveform with 5 Mpts, a third waveform with 4 Mpts, and a fourth waveform with 6 Mpts as shown in figure below.

4080B Arbitrary Waveform Memory Bank 1 of 8

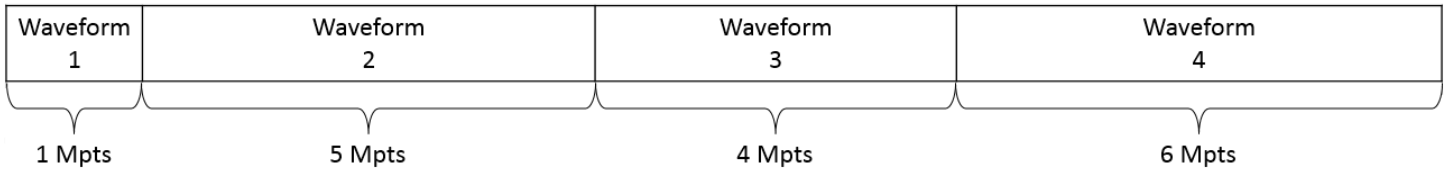

1. First, create or load 16,777,216 waveform data points into arbitrary waveform memory. For more information, please see the [Creating an Arbitrary Waveform](#) section.
2. Save all 16,777,216 points into ARB Wave 1 using the “Save ARB” key in the SETUPS menu.
3. Reference each waveform in the memory bank according to their starting point and length. Using the “Store” key in the SETUPS menu, save the parameters for each waveform to separate Setup memory locations as follows:

Setup 1 ARB parameters: Start address = 1; Length = 1,000,000 points

Setup 2 ARB parameters: Start address = 1,000,001; Length = 5,000,000 points

Setup 3 ARB parameters: Start address = 6,000,002; Length = 4,000,000 points

Setup 4 ARB parameters: Start address = 10,000,003; Length = 6,000,000 points

To save edited arbitrary waveforms into Waveform Memory, the instrument will display a message "SAVE DATA" after each modification of the arbitrary waveform in the EDIT menu. Please note that any subsequent saving of data will rewrite the entire arbitrary waveform memory bank. Therefore, in order to properly segment the entire range of points in Waveform Memory for Setup recall, the full length of data points should be saved to Waveform Memory first.

Note: Since it is impossible to guarantee 100% of the time against loss of stored data, you should maintain a record of the data stored in memory so that you can manually restore such data, if necessary.

3.7 Displaying Errors

At power-on, the waveform generator performs a diagnostic routine to check itself for problems. If the diagnostic routine finds an error, an error message is displayed. The waveform generator also displays error messages when front-panel settings are either invalid or may produce unexpected results.

Message Text	Cause
Out of range	Attempt to set variable out of instrument limits.
Setting conflict	Can't have this parameter set with some other.

Trig rate short	Internal trigger rate too short for wave/burst.
Empty location	Attempt to restore nonexistent setting.
SCALE too high	Attempt to set scale too high for current dot value
Protected RAM	Attempt to write to protected RAM range.
RAM error	Error in testing RAM.
Save RAM	New firmware installed.
Must divide by 4	Predefined wave length must be divisible by 4.
Must divide by 2	Predefined wave length must be divisible by 2.

3.8 Creating an Arbitrary Waveform

You can create an arbitrary waveform using the following methods:

- Enter individual data points
- Draw lines between data points
- Create a predefined waveform
- Export a waveform from software
- Create data points using SCPI commands

The waveform's frequency and amplitude are influenced by the number of data points and their value in the waveform. For further information on how the number of data points influence the frequency and amplitude of a waveform in execution memory, see *Setting the Frequency* section (on page 32) and *Setting the Amplitude* section (on page 33), respectively.

Entering Individual Data Points

The most basic way to program an arbitrary waveform is to enter data points for the waveform, one data point at a time. While this can become tedious, the auto-increment function helps this process. To enter individual data points into waveform memory, follow these steps:

1. Press **WAVE** main key to display the selection menu.
2. Press F5: ARB to display the arbitrary menu.
3. Press F4: EDIT to display the Edit menu.
4. Press F1: POINT to select the point-by-point programming mode.
5. Press F1: ADRS.
6. Use the rotary knob or the numerical keypad to enter the address.
7. Press F2: DATA.
8. Use the rotary knob or the numerical keypad to enter the value for the data point. Valid entries range from -8191 to 8191.
9. Repeat steps 5 through 8 for additional points until you finish creating your arbitrary waveform.

Creating a Complex Arbitrary Waveform

To create a complex arbitrary waveform:

- Load a predefined sine waveform
- Load a scaled sine waveform at the positive peak of the first sine wave
- Draw a straight line between two data points in the waveform
- Add a pulse/glitch to the waveform
- Add a noise signal at the negative peak of the first sine wave

To see the waveform as you build it, connect the waveform generator to an oscilloscope and perform the following steps:

Note: The user must press **ENTER** to confirm any input data value (Start address, Length, etc.) when performing the following steps.

ACTION

Loads the first 1000 points of waveform memory.

KEYSTROKES

WAVE
F5: ARB
F1: START
1
F2: LENGTH
1000
F5: PREV
MODE
F1: CONT
OUTPUT ON

The following steps set up the waveform shown in Figure 3.24.

ACTION

Step 1: Load a 1000-point, 50% scaled, predefined sine wave into waveform memory starting at address 1.

KEYSTROKES

WAVE
F5: ARB
F4: EDIT
F3: PREDEF
F1: TYPE (rotate knob for selection)
SINE
F2: FROM/DATA
1
F3: LENG
1000
F4: SCAL
50
F5: EXEC

Step 2: Load a 5% scaled, 100-point predefined waveform into waveform memory starting at address 200.

F3: YES
F3: PREDEF
F1: TYPE
SINE
F2: FROM
200
F3: LENG
100
F4: SCAL
5
F5: EXEC
F3: YES

Step 3: Draw a line between address 251 (the highest point of the sine wave) and address 501 (where the sine wave crosses the origin).

F2: LINE
F1: FROM
251
F2: TO
501
F4: EXEC
F3: YES

Step 4: Add a negative pulse/glitch (data value -8191) at addresses 600 through 606.

F1: POINT
F1: ADRS
600
F2: DATA
-8191
(repeat -8191 and ENTER
for addresses 601-606)
F5: PREV

Step 5: Add a 5% noise signal to addresses 700 through 800.

F3:PREDEF
F2:FROM
700
F3:LENG
100
F4:SCAL
5
F1:TYPE
NOISE
F5:EXEC
F1:ADD
F4:EXEC
F3-YES

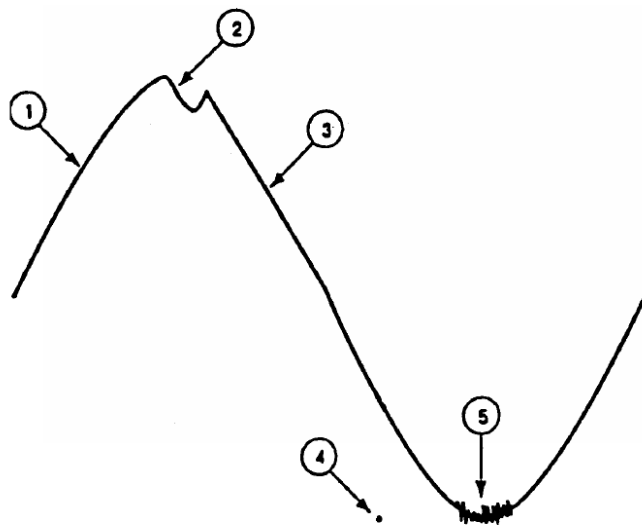

Figure 3.24 - Steps to set up an Arbitrary Waveform

Setting the Frequency

The arbitrary waveform frequency is a function of the number of data points used to run the waveform (the length parameter in the ARB menu) and the waveform execution point rate. The waveform execution point rate is the execution time between each point in the waveform. The total time taken to run one period of the waveform is given by:

$$\text{Total time} = \# \text{ of points} \cdot \text{rate}$$

Because the output frequency is a function of the rate and the number of points being executed, the output frequency is calculated as:

$$\text{frequency} = \frac{1}{\# \text{ of points} \cdot \text{rate}}$$

For example, to set the output frequency to 1000 Hz, given the number of data points used for the waveform output is 1000, the rate is calculated as:

$$\text{rate} = \frac{1}{1000 \text{ pts} \cdot 1000 \text{ Hz}} = 1 \mu\text{s}$$

EXAMPLE: Setting the Output Frequency

To set the output frequency of a 1000-point waveform to 1000 Hz, set the rate to 1 μs :

ACTION

Step 1. Set the output rate to 1 μs (equivalent to 1000 Hz output frequency)

KEYSTROKES

PARAM

F1: RATE

1

KHz/us

Setting the Amplitude

The following equation represents the relative output amplitude voltage relationship between the front-panel amplitude peak-to-peak setting and the data point values in waveform memory:

$$\text{output voltage} = \frac{\text{Amplitude } p - p \text{ setting} \cdot \text{data point value}}{16382} + \text{offset}$$

Where 16382 is the total data point value range in waveform memory.

Table 3.5 - Relative Amplitude for Waveform Output (Examples)

Front Panel Amplitude Setting	Data Point Value	Relative Output Amplitude Voltage
5 V p-p	8191	2.5 V positive peak
5 V p-p	0	0 V (offset voltage)
10 V p-p	-8191	5 V positive peak

Loading an Arbitrary Waveform

To load a section of arbitrary waveform memory, specify its start address and length in the ARB menu:

1. Select the channel to **ON**.
2. Press **WAVE** and select the F5: ARB function.
3. Press F1: START to display the start address and use the rotary input knob or the numerical keys to enter the address.
4. Press F2: LENGTH to display the length of the waveform and use the rotary input knob or the numerical keys to enter the length.

Note: The starting address must be an odd number. If an even number is entered, the instrument will automatically decrement one value to an odd number. For example, if you set start address to 2000 and press **ENTER**, it will display 1999. The length value must always be an even number. If you input an odd number length, a message will pop up and say “Even wave length” and then decrement one value to an even number. For example, if you entered 1001 as the length, the message will pop up for one second and change the value automatically to 1000.

3.9 Remote Interface

USB Interface

The instrument has a USB interface (USBTMC) on the rear panel for remote communication. From the **UTIL** menu, press USB to select the USB interface.

To communicate with the unit, you must install the USB driver. For Windows® 7 and 8 users, this may install automatically. For other users, visit www.bkprecision.com to download the driver.

Note: Users who have LabVIEW™ or NI-VISA installed will automatically have this driver in their system. In this case, driver download is not required.

GPIB Interface

GPIB Address

The instrument has an optional GPIB interface on the rear panel for remote communication. The optional GPIB interface is shipped with the address set to decimal 9. The address can be changed from the front panel by using the **UTIL** menu (refer to UTILITY Key section on page 25).

GPIB Connection

The rear panel GPIB connector connects to a standard IEEE-488 bus cable connector. The GPIB line screens are not isolated from chassis and signal ground.

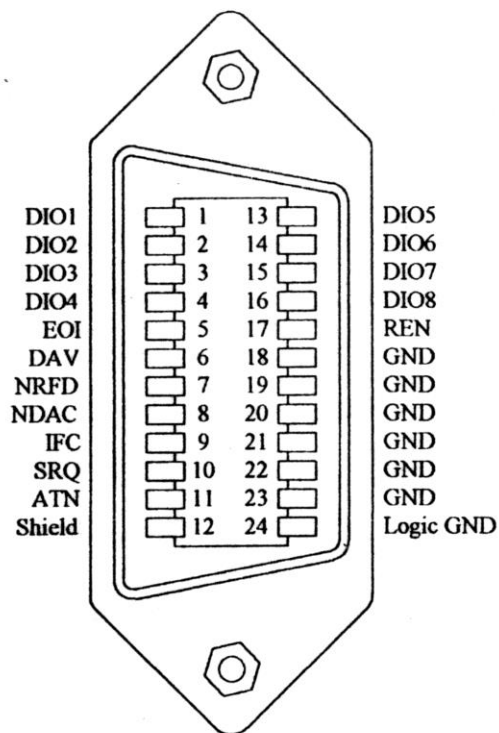

Figure 3.25 – Standard GPIB connector

4 Programming

4.1 Overview

GPIB

This section provides detailed information on programming the 4075B Series generators via IEEE-488 GPIB interface. The command syntax as defined by the IEEE 488.2 and SCPI standards are explained in this chapter.

4.2 Device State

The device may be in one of the four possible states described below. The transition between states is defined by IEEE 488.1.

Local State (LOCS)

In LOCS, the device may be operated from the front panel only. Its settings may be queried over the GPIB, but not changed. Commands that do not affect the signal being output by the instrument are accepted.

Local With Lockout State (LWLS)

In LWLS, the device may be operated from the front panel only. Its settings may be queried over the GPIB, but not changed. Commands that do not affect the signal being output by the instrument are accepted. The difference between the LOCS and the LWLS is that from the LWLS the device may enter the Remote With Lockout State.

Remote State (REMS)

In REMS, the device may be operated from the GPIB. Actuating any front panel key will cause the device state to revert to the LOCS.

Remote With Lockout State (RWLS)

In the RWLS the device is operable only from the GPIB. Front panel operation may be returned by either sending an appropriate IEEE 488.1 command, or by cycling the device power.

4.3 Interface Function Subsets

The following interface function subsets are implemented in the 4075B series:

SH1, AH1, T6, L4, SR1, RL1, PP0, DC1, DT1, E2, C0

4.4 Device Address

The GPIB address of the device may be set to any value from 0 to 31. The address may be changed from the front panel, using the numeric keypad or the rotary encoder, or via the GPIB itself using the

command:

:SYSTem:COMMunicate:GPIB:ADDRes

Setting the device to address 31 puts it in the 'off-bus' state. In this state it will not respond to messages on the GPIB. If the device is in the REMS when set to address 31, an internal 'return-to-local' command will be given, setting the device to the LOCS. If the device is in the RWLS, the 'return-to-local' command is ignored, and the device remains in the RWLS. The only way to then re-establish communication with the device over the GPIB is to cycle the power, and to then change the address to that required from the front panel.

4.5 Message Exchange Protocol

The device decodes messages using the Message Exchange Protocol (MEP) defined in IEEE 488.2. The following functions implemented in the MEP must be considered:

The Input Buffer

The device has a 256-byte long cyclic input buffer. Decoding of remote messages begins as soon as the input buffer is not empty, that is, as soon as the controller has sent at least one byte to the device. Should the input buffer be filled up by the controller faster than the device can remove the bytes and decode them, the bus handshake is not completed until room has been made for more bytes in the buffer. This prevents a fast controller from overrunning the device with data.

If the user has sent part of a Program Message, but not the Program Message Terminator, and he wishes to abort the message decoding and execution, the Device Clear command may be sent, or front panel operation resumed (in REMS only).

The Output Queue

The device has a 100-byte long output queue in which it stores response messages for the controller to read. If at the time a response message is formatted the queue contains previously formatted response messages, such that there are not enough places in the queue for the new message, the device will put off putting the message in the queue until there is place for it.

The Status Byte MAV bit, when set, indicates that part or all of a response message is ready to be read.

Response Messages

The device sends a Response Message in response to a valid query. All queries return a single Response Message Unit. In only one case is the Response Message generated when the response is read (as opposed to when the response is parsed), and this is when querying Arbitrary Waveform data. All other queries generate the Response Message when they are parsed.

Coupled Commands

Coupled Commands are either commands whose execution validity depends on the value of other parameters, or commands whose execution changes the value of another parameter. The execution of commands designated as being coupled is deferred until all other commands in the same Program

Message have been executed. The coupled commands are then grouped together according to their functionality, and executed as a group. These groups of coupled commands are defined in the 4075B series:

- a) The commands to set the amplitude, the offset, and to switch the output on. The output being switched on is included here in order to prevent possible damage to the equipment being driven as a result of the amplitude and offset not being executed as intended by the user, due to an execution error.
- b) The commands to set the function, frequency, the point rate, the wavelength, and the waveform start address. In ARB function, setting the frequency or the point rate causes the other to change, keeping the wavelength constant (if it, too, is not specified in the same program message). If the wavelength is specified as well, the frequency or point rate must change in accordance with the new value. The validity of the start address is a function of the wavelength. Please refer to the individual commands for more detail.
The maximum frequency is also dependent upon the waveform, so that changing the waveform may render the current frequency out of range.
- c) The commands to set modulation, modulation source and the function are inter-related. FM and FSK are not available for ARB function. External source of modulation can be active for either FM or AM but not both. FSK and FM cannot be active at the same time.
- d) Sweep start and sweep stop frequencies must be distanced more than the minimum allowed for sweep to function correctly.

4.6 Block Data

Arbitrary waveform values may be sent to the device in one of three formats:

- a) ASCII values
- b) Definite form arbitrary data
- c) Indefinite form arbitrary data

Essentially we would like to check the execution validity of all the data of a command before execution. When downloading a long arbitrary waveform, however, it is not possible to check all the data sent before execution, since this would require excessive amounts of memory. The following compromise has therefore been reached:

An arbitrary waveform is limited in length only by the amount of waveform memory. Each point is checked and then written to memory. If an invalid value is detected all subsequent values are discarded, and an execution error is flagged.

Querying arbitrary waveform data will result in a Response Message containing only as many points as the user requested.

4.7 Instrument Identification

The *IDN? common query is used to read the instrument's identification string. The string returned is something similar to the following:

B&K Precision, 4080B, 0, V1.00

4.8 Instrument Reset

The *RST common command effects an instrument reset to the factory default power up state.

4.9 Self-test

The *TST common query causes the device to perform a self-test. This self-test consists of checking the functionality of the arbitrary waveform memory.

4.10 Command Syntax

General Command Structure

The device commands are generally defined by the SCPI standard, with the exception of those instrument functions for which SCPI commands do not as yet exist. The Common Commands and Queries are defined by IEEE 488.2. The command syntax, i.e. how a command is structured, is defined by IEEE 488.2.

A Program Message is defined as a string containing one or more Program Message Units, each of which is an instrument command or query. Program Message Units are separated from each other by the Program Message Unit Separator. The Program Message is terminated by the Program Message Terminator.

The Program Message Unit Separator consists of a semicolon (';'), optionally preceded and/or followed by whitespace characters. A whitespace character is defined as the ASCII characters in the ranges 00H-09H, and 0BH-20H. This range includes the ASCII control characters and the space, but excludes the Linefeed character.

The Program Message Terminator consists of optional whitespace characters, followed by one of three options:

- a) The Linefeed (LF) character (ASCII 0A)
- b) The GPIB EOI bus line being set true on the last byte of the message
- c) LF being sent with EOI true

The Program Message Unit can be divided into three sections as follows:

- a) Program Header

The Program Header represents the operation to be performed, and consists of ASCII character mnemonics. Two types of Program Headers are used in the 4075B series: Instrument-control headers and Common Command and Query headers. A Program Header may consist of more than one

mnemonic, in which case the mnemonics are separated from each other by the colon (':'). For instrument control commands, the mnemonics are specified by the SCPI standard, and indicate the tree structure of the command set. The first mnemonic indicates the subsystem being controlled. Common Command and Query Program Headers consist of a single mnemonic prefixed by an asterisk ('*').

The mnemonics consist of upper - or lower-case alpha characters. Mnemonics may be written in either the long form, in which the entire mnemonic is written out, or the short form, in which only a specified portion of the mnemonic is written out. Some mnemonics have only one form due to their short length. Where a command is described, the portion appearing in upper case is the short form. Only the short form or the long form may be used.

Example: The command to set the frequency to 1 kHz may be written in the following ways:

```
SOURCE:FREQUENCY 1KHZ
SOUR:FREQ 1KHZ
SOURCE:FREQ 1KHZ
```

Some mnemonics in a specified Program Header may be optional. This is indicated in the command description by the mnemonic being enclosed in square brackets ([...]). This means it is not necessary to write the mnemonic into the Program Header: it is a default condition. The 'SOURCE' mnemonic, for example, is optional. Not specifying it will cause the device to search for the mnemonics in the Program Header under the Source Subsystem. For example, the frequency may be set by the commands

```
FREQ:CW 1KHz
FREQ 1KHz
```

since the 'CW' mnemonic is also optional.

b) Program Header Separator

The Program Header Separator is used to separate the program header from the program data. It consists of one or more whitespace characters, denoted as <ws>. Typically, it is a space.

c) Program Data

The Program Data represent the values of the parameters being set, for example, the '1KHZ' in the above examples. Different forms of program data are accepted, depending on the command. The Program Data types used in the instrument are:

i. Character program data

This form of data is comprised of a mnemonic made up of lower - or upper-case alpha characters. As with Program Header mnemonics, some Character Data mnemonics have short and long forms. Only the short or the long form may be used.

ii. Boolean data

Boolean data indicate that the parameter can take one of two states, ON or OFF. The parameter may be character type ON or OFF or numeric. A numeric value is rounded to an integer. A non-zero result is interpreted as 1 (ON), and a zero result as 0 (OFF). Queries return the values 0 or 1.

iii. NRf

This is a decimal numeric data type, where NR1 indicates an integer number, NR2 indicates a fixed point real number, and NR3 indicates a floating point real number.

iv. Expression data

An expression is contained in parentheses (...). This data type is used only with the STATUS:QUEue:ENABLE command.

v. Numeric value program data

This data type defines numeric values, as well as special cases of Character Data. Numeric values may be specified in any of Integer, Fixed Point or Floating Point format. All parameters which have associated units accept a suffix, which may be specified using upper or lower-case characters. When the suffix is not specified, the numeric value is accepted in the default units, which are Hertz for frequency, Seconds for time, and Volts for voltage. To set the frequency to 1 KHz we can send one of the following commands:

```
FREQ 1000  
FREQ 1E3
```

The special forms of character data accepted as numbers are

```
MAXimum: sets the parameter to its maximum value.  
MINimum: sets the parameter to its minimum value.
```

For example, to set the frequency to its maximum value we can send the command

```
FREQ MAX
```

vi. Arbitrary Block Data

The Arbitrary block data type is used to send arbitrary waveform data to the instrument. In this data type, the waveform points are specified in binary format, and each point consists of two bytes. Two types of arbitrary block data are defined (by IEEE 488.2):

Definite Form

The Definite Form has the structure

-#-Byte Count Length - Byte Count - 8-bit byte

The Byte Count Length consists of a single ASCII digit from 1 to 9. It tells the parser how many digits are in the Byte Count.

The Byte Count is a decimal integer made up of the number of digits specified in the Byte Count Length. It tells the parser how many 8-bit bytes are being sent.

Indefinite Form

The Indefinite Form has the structure

- # - 0 – 8-bit byte – LF^EOI

Some Program Message Units either require, or can accept, more than one data element. Program data elements are separated from each other by the Program Data Separator. It is defined as optional whitespace characters followed by a comma (','), which in turn is followed by optional whitespace characters.

There are two types of Program Message Units: Command Message Units and Query Message Units. A Query differs from a Command in that the Program Header is terminated with a question mark ('?'). For example, the frequency might be queried with the following query:

FREQ?

Some Query Message Units accept data, giving the device more specific information about what is being queried. In many cases the Query Message Unit may optionally be supplied with the MIN or MAX mnemonics as data. This tells the device to return the minimum or maximum value to which the parameter may currently be set. For example,

FREQ? MAX

will return the maximum value to which the frequency may currently be set.

Not all Program Message units have query forms (for example, STATUS:PRESET), and some Program Message Units might have only the query form (for example SYSTEM:VERSION?).

The instrument puts the response to the query into the output queue, from where it may be read by the controller. The Status Byte MAV bit is set to indicate to the controller that a response is ready to be read.

SCPI Command Structure

SCPI commands are based on a hierarchical structure. This allows the same instrument-control header

to be used several times for different purposes, providing that the mnemonic occurs in a unique position in the hierarchy. Each level in the hierarchy is defined as a node. Mnemonics in the different levels are separated from each other by a colon (':'). The first Program Message Unit, or command, in a Program Message is always referenced to the root node. Subsequent commands are referenced to the same level as the previous command. A Program Message Unit having a colon as its first character causes the reference to return to the root. This process is defined by IEEE 488.1, section A.1.1. Consider the following examples:

- a) The following command may be used to set the amplitude and the offset of the signal.

```
SOURCE:VOLTAGE:AMPLITUDE 5V;OFFSET 2V
```

Note that the offset command is referenced to the command preceding it: the OFFSET mnemonic resides at the same node as the AMPLITUDE command.

- b) This command set the frequency and the amplitude.

```
SOURCE:FREQUENCY 2KHZ;VOLTAGE:AMPLITUDE 4V
```

The FREQUENCY and VOLTAGE mnemonics are at the same level.

- c) When Program Message Units describe different subsystems, a colon prefix must be used to reset the command reference to the root. Here the frequency and the output state are set.

```
SOURCE:FREQUENCY 3KHZ;:OUTPUT:STATE ON
```

Common Commands may be inserted in the Program Message without affecting the instrument-control command reference. For example,

```
SOURCE:VOLTAGE:AMPLITUDE 4V;*ESE 255;OFFSET 2V
```

In an instrument with multiple channels, the selection of which channel to use is achieved through the use of a numeric suffix indicating the channel, attached to the root level mnemonic. Four root level mnemonics are channel - dependent, and these are SOURce, TRIGger, OUTPut and ARBitary. When the channel is not specified, channel 1 is assumed. Program message units that are referred back to a specific root level mnemonic operate on the channel specified in that mnemonic.

Examples:

- a) SOUR:FREQ 5KHZ;VOLT:AMPL 3V

Sets the frequency and amplitude of the first channel (default).

- b) SOUR2:FREQ 5KHZ;VOLT:AMPL 3V

Sets the frequency and amplitude of channel 2.

- c) ARB2:START 100;LENGTH 50

Sets the start address and length of the waveform being output on channel 2.

4.11 Status Reporting

The instrument is capable of reporting status events and errors to the controller, using the IEEE 488.1 Service Request function and the IEEE 488.2 Status Reporting structure.

The Status Byte

Status summary information is communicated from the device to the controller using the Status Byte (STB). The STB is composed of single-bit summary-messages, each summary message summarizing an overlying Status Data Structure. By examining the content of the STB, the controller gains some information concerning the instrument's status.

The STB bits are defined as follows:

- Bit 0: Unused
- Bit 1: Unused
- Bit 2: Error/event queue summary message (EVQ). This bit is set if the queue is not empty.
- Bit 3: Questionable Status summary message.
- Bit 4: Message Available (MAV) summary message. This bit is set whenever all or part of a message is available for the controller to read. The controller may be ready to read the response message before it is available, in which case it can either wait until this bit is set, or it can start to read. In the second case, the controller timeout must be set so that the read action will not be aborted before the message has been read.
- Bit 5: Event Status Bit (ESB) summary message. This bit is set to indicate that one or more of the enabled standard events have occurred.
- Bit 6: Request Service (RQS). This bit is set when the device is actively requesting service.
- Bit 7: Operation Status summary message. No Operation Status events are defined in the instrument, and so this bit is never set.

The STB is read by the controller during a serial poll. If the RQS bit was set, it is then cleared. The STB may also be read by the *STB? common query.

Service Request Enabling

Service request enabling allows the user to select which Status Byte summary messages may cause the device to actively request service. This is achieved using the Service Request Enable Register, which is an 8-bit register whose bits correspond to those of the STB. The RQS bit in the STB is set when a bit in the STB is set, and its corresponding bit in the service request enable register is set.

The service request enable register is set using the *SRE common command, and read using the *SRE? common query.

Standard Event Status Register

The Standard Event Status Register (SESR) is defined by IEEE 488.2. It is implemented in the instrument as a byte, whose bits have the following definitions:

- Bit 0: Operation Complete (OPC). This bit is set in response to the *OPC common command being executed.
- Bit 1: Request Control (RQC). Not implemented.
- Bit 2: Query Error (QYE). This bit is set when either the controller is attempting to read data from the device when none is available, or when data prepared for the controller to read has been lost.
- Bit 3: Device-Specific Error (DDE). This bit is set to indicate that a device operation did not execute due to some device condition. For example, trying to recall an uninitialized device stored setting.
- Bit 4: Execution Error (EXE). This bit is set when the device could not execute a command, due to the command being outside of it's capabilities. For example, a parameter being out of range.
- Bit 5: Command Error (CME). This bit is set to indicate an error in the command syntax.
- Bit 6: User Request (URQ). This bit is not used.
- Bit 7: Power On (PON). This bit is set when the device is powered on.

The SESR is queried using the *ESR? common query.

The SESR is paired with an enable register, the Standard Event Status Enable Register (SESER). This register enables one or more events in the SESR to be reflected in the Status Byte ESB summary message bit. The bits of the SESER correspond to those of the SESR. Setting a bit in the SESER enables the corresponding event to set the ESB bit when it occurs. The SESER is set with the *ESE common command and queried with the *ESE? command query.

The Error Queue

The error queue is used to store codes of errors detected in the device. It is implemented as a cyclic buffer of length 10. When the error queue is not empty, bit EVQ in the Status Byte is set. The error queue is read with either one of the following two queries:

```
:SYSTEM:ERROR?
:STATUS:QUEUE:NEXT?
```

The first error in the queue is returned, and the queue is advanced.

Error Codes

The negative error codes are defined by SCPI. Positive codes are specific to the instrument. The error message is returned in the form:

```
<error number>,"<error description>"
```

A table of error numbers and their descriptions is presented here.

No error reported

```
0      No error
```

Command Errors

A command error is in the range -199 to -100, and indicates that a syntax error was detected. This includes the case of an unrecognized header. The occurrence of a command error causes the CME bit (bit 5) of the Standard Event Status Register to be set.

-100	Command Error
-101	Invalid character
-102	Syntax error
-103	Invalid separator
-104	Data type error
-105	GET not allowed
-108	Parameter not allowed
	More parameters than allowed were received
-109	Missing parameter
	Fewer parameters than necessary were received
-110	Command header error
-111	Header separator error
-112	Program mnemonic too long
	The mnemonic must contain no more than 12 characters.
-114	Header suffix out of range; Only suffix of 1 or 2 is valid, indicating the channel being operated.
-113	Undefined header
-120	Numeric data error
-121	Invalid character in number
-123	Exponent too large
	IEEE 488.2 specifies maximum of 32000
-124	Too many digits
	IEEE 488.2 specifies maximum of 255 digits in mantissa.
-128	Numeric data not allowed
	A different data type was expected
-131	Invalid suffix
-134	Suffix too long
	A maximum of 12 characters are allowed in a suffix.
-138	Suffix not allowed
-140	Character data error.
-141	Invalid character data.
	Incorrect character data were received.
-144	Character data too long
	Character data may contain no more than 12 characters.
-148	Character data not allowed
-158	String data not allowed
-161	Invalid block data
	An error was found in the block data
-168	Block data not allowed

-170	Expression error Only 6 error ranges may be specified.
-171	Invalid expression An error was found in the expression.
-178	Expression data not allowed

Execution Errors

An execution error indicates that the device could not execute a syntactically correct command, either since the data were out of the instrument's range, or due to a device condition. The EXE bit (bit 4) of the Standard Event Status Register is set on occurrence of an execution error.

-200	Execution error An attempt was made to RECALL the contents of an uninitialized stored setting buffer.
-201	Invalid while in local.
-211	Trigger ignored. The GET or *TRG common command was ignored due to the device not being in the correct state to execute the trigger.
-220	Parameter error. A parameter is in the correct range, but conflicts with other parameters.
-221	Settings conflict. The parameter is out of range due to the current instrument state.
-222	Data out of range.
-223	Too much data. The arbitrary waveform memory limit has been exceeded.
-224	Illegal parameter value. The parameter value must be selected from a finite list of possibilities.
-241	Hardware missing; A command was sent to operate a non-existent channel.
-258	Media protected. An attempt was made to write to protected arbitrary waveform memory.

Device-Specific Errors

An error specific to the device occurred. The DDE bit (bit 3) of the Standard Event Status Register is set.

-315	Configuration memory lost. Device memory has been lost.
-330	Self-test failed.
-350	Queue overflow. Error codes have been lost due to more than 10 errors being reported without being read.

Query Errors

A query error indicates that the output queue control has detected a problem. This could occur if either an attempt was made to read data from the instrument if none was available, or when data were lost. Data could be lost when a query causes data to be formatted for the controller to be read, and the controller sends more commands without reading the data.

-410	Query INTERRUPTED. Data were sent before the entire response of a previous query was read.
-420	Query UNTERMINATED. An attempt was made to read a response before the complete program message meant to generate that response was sent.
-430	Query DEADLOCKED. The input buffer and output queue are full, and the controller is attempting to send more data. In this case the output queue and input buffers will be cleared. Parsing will resume after the END message is detected.
-440	Query UNTERMINATED after indefinite response. A query was received in the same program message after a query requiring an indefinite response was formatted. Essentially this means that the *IDN? common query and the :ARB:DATA? query should not be followed by more query messages in the same program message.

System Events

System events have positive valued codes. They are not defined by SCPI, but are specific to the instrument. Sending the :STATus:PRESet command will disable these events from being reported.

401	Power on
402	Operation complete The *OPC command has been executed.

Warnings

The execution of some commands might cause an undesirable instrument state. The commands are executed, but a warning is issued. Sending the :STATus:PRESet command disables reporting of warnings. The existence of these conditions causes a bit in the Status Questionable Condition register to be set (refer to section Questionable Condition).

500	Trigger rate short on channel 1
501	Trigger rate short on channel 2
510	Output overload on channel 1
511	Output overload on channel 2

"Trigger rate short" means that the period of the waveform is larger than the value of the internal trigger rate. Thus not every trigger will generate a cycle (or burst) of the waveform.

4.12 Common Commands

The following section describes the common commands according to the IEEE 488.2 specifications. These commands are applicable for both GPIB and USB interface.

System Data Commands

- a) ***IDN?** - Identification query
The identification query enables unique identification of the device. This query should always be the last in a program message. It returns a string with four fields:

Manufacturer name
Model name
Serial number (0 if not relevant)
Version number

Command

Type: Common Query

Syntax: *IDN?

Response: B&K Precision, MODEL 4080B,0,V0.82

- b) ***OPT?** - Option identification query
The Option Identification Query is used to identify device options over the system interface. This query should always be the last in a program message.

Command

Type: Common Query

Syntax: *OPT?

Response: No option available.

Internal Operation Commands

- a) ***RST** - Reset command
The Reset command performs a device reset. It causes the device to return to the factory default power up state.

Type: Common Command

Syntax: *RST

- b) ***TST?** - Self-test query
The self-test query causes an internal self-test to be performed. This test consists of checking the integrity of the arbitrary waveform memory.

Type: Common Query

Syntax: *TST?

Response: ASCII 0 if test passes
ASCII 1 if test fails

Synchronization Commands

- a) ***OPC** - Operation complete command

The operation complete command causes the device to generate the operation complete message in the Standard Event Status Register, on completion of the selected device operation.

Type: Common Command

Syntax: *OPC

Examples: FREQ 5KHZ;*OPC

The *OPC command (and the *OPC? query described below) find use mainly when commands having relatively long execution times are executed, for example the programming of long predefined waveforms.

- b) ***OPC?** - Operation complete query

The operation complete query places an ASCII character 1 in the output queue on completion of the selected device operation.

Type: Common Query

Syntax: *OPC?

Response: ASCII character 1

Example FREQ 1KHz;*OPC?

- c) ***WAI** - Wait-to-continue command

This command is intended for use with overlapped commands. No commands in the instrument are overlapped, and so this command has no effect.

Type: Common Command

Syntax: *WAI

Status and Event Commands

- a) ***CLS** - Clear status

The clear status command clears the SESR and Error Queue status data structures.

Type: Common Command

Syntax: *CLS

- b) ***ESE** - Standard event status enable

This command is used to set the value of the Standard Event Status Enable Register.

Arguments

Type: NRf

Range: 0 to 255. Non integer arguments are rounded before execution.

Type: Common Command or Query
Syntax: *ESE<ws><NRf>
Examples: *ESE 48 (Enables the CME and EXE bits)
*ESE 255 (Enables all standard events)

Query
Syntax: *ESE?
Response: <NR1>

- c) ***ESR?** - Standard event status register query
This query is used to read the value of the Standard Event Status Register. Reading the register clears it.

Type: Common Query
Syntax: *ESR?
Response: <NR1>

- d) ***PSC** - Power on status clear command
This command is used to control the automatic power-on clearing of certain status functions.

Arguments
Type: Boolean
Type: Common Command or Query
Command
Syntax: *PSC<ws><Boolean>
Examples: *PSC ON or *PSC 1
*PSC OFF or *PSC 0
Query
Syntax: *PSC?
Response: ASCII 0 for OFF
ASCII 1 for ON

When set to ON (1), the Service Request Enable Register and the Standard Event Status Enable Register are cleared on power-on.

- e) ***SRE** - Service request enable command
This command sets the Service Request Enable Register bits.

Arguments
Type: NRf
Range: 0 to 255. Non integer arguments are rounded before execution.
The value of bit 6 is ignored, and is set always to zero.
Type: Common Command or Query
Syntax: *SRE<ws><NRf>
Examples: *SRE 48 (Enables reporting of ESB and MAV events)
Query

Syntax: *SRE?
Response: <NR1>

f) ***STB?** - Status byte query

This query is used to read the value of the Status Byte.

Type: Common Query
Syntax: *SSTB?
Response: <NR1>

The value of the Status Byte read with the *STB? query may differ from that read with the Serial Poll. Bit 6 of the STB will be set as long as a reason for requesting service exists, while bit 6 of the STB as read by the Serial Poll is cleared by the Serial Poll.

Device Trigger Commands

a) ***TRG** - Trigger command

This command is analogous to the IEEE 488.1 Group Execute Trigger interface message, and has the same effect. It is used to trigger the device to output a wave, and is accepted only when the trigger mode is set to Trigger, Gate or Burst, and the trigger source is set to BUS.

Type: Common Command
Syntax: *TRG

Stored Settings Commands

a) ***RCL** - Recall instrument state

This command is used to restore the state of the device to that stored in the specified memory location.

Arguments

Type <NRf>
Range 0 to 49. Non integer values are rounded before execution

Type: Common Command
Syntax: *RCL<ws><NRf>
Example: *RCL 0 (Recall default state)
 *RCL 49

Stored setting location 49 stores the last instrument setting before power down.

b) ***SAV** - Save instrument state

This command is used to store the current instrument state in the specified memory location.

Arguments
 Type: NRf
 Range: 1 to 49. Non integer values are rounded before execution
 Type: Common Command or Query
 Syntax: *SAV<ws><NRf>
 Examples: *SAV 25

4.13 Instrument Control Commands

Instrument control commands are grouped into logical subsystems according to the SCPI instrument model. The commands are comprised of mnemonics indicating the subsystem to which the command belongs, and the hierarchy within that subsystem. When the command is to be referred to the Root node, it should be prefixed with a colon (:). Mnemonics appearing in square brackets [...] are optional. The '|' character is used to denote a choice of specifications. The '<ws>' is used to denote a white space character.

All commands except those in the STATus and SYSTem subsystems, and commands specifically indicated, are channel-dependent. Commands are referenced to channel 1 by default. The numeric suffix '2' must be appended to the subsystem mnemonic to refer a command to channel 2. (See SCPI Command Structure)

SOURce Subsystem

The Source Subsystem controls the frequency, voltage, amplitude modulation and clock source. The command structure is as follows:

```
:SOURce
  :FREQuency
    [:CW|:FIXed] <numeric value>
  :FUNctIon
    [:SHAPE] SINusoid|SQUare|TRIangle| |ARBitrary| |PULSe
  : DCYcle ] <numeric value>
  :VOLTage
    [:AC]
      [:LEVel]
        [:IMMediate]
          [:AMPLitude] <numeric value>
          :OFFSet <numeric value>
  :REFerence
    INTernal | EXTernal
  :ROSCillator
    [:SOURCE] INTernal | EXTernal

:AM
```

```

[:STATe] <Boolean>
:DEPTh <numeric value>
:SHAPE SINusoid|SQUare|TRIangle
:FREQuency <numeric value>
:SOURce INTernal |EXTernal

:FM
[:STATe] <Boolean>
:DEVIation <numeric value>
:SHAPE SINusoid|SQUare|TRIangle
:FREQuency <numeric value>
:SOURce INTernal |EXTernal

:FSK
[:STATe] <Boolean>
:LOWFrequency <numeric value>
:HIFrequency <numeric value>
:RATE <numeric value>
:SOURce INTernal |EXTernal

:SWEep
STATe <Boolean>
:SPACing <LIN|LOG>
:TIME <numeric value>
:START <numeric value>
:STOP <numeric value>

:PHAsE
[:ADjust] <numeric value >
SYNChronize

:PULSe
:PERiod <numeric value >
:WIDth <numeric value >
:EDGE <numeric value >
:RISe <numeric value >
:FALL <numeric value >

```

Frequency

```
:SOURce:FREQuency <frequency>
```

The frequency command controls the frequency of the output waveform.

Arguments

Type:	Numeric.
Units:	MHz, KHz, Hz (default)
Range:	Dependent on the Point Rate and Wavelength. Fmax = 1/(5 ns * Wavelength)

$F_{min} = 1/(100 S * \text{Wavelength})$
 Rounding: The value is rounded to 4 digits.
 Command Type: Setting or Query
 Setting
 Syntax: [:SOURce]:FREQuency[:CW]<ws><frequency>[units]
 [:SOURce]:FREQuency<ws>MINimum | MAXimum
 Examples: :FREQ 5KHZ
 :FREQ 5E3
 :FREQ MAXIMUM
 :FREQ MIN
 Query
 Syntax: [:SOURce]:FREQuency[:CW]?[<ws>MAXimum | MINimum]
 Examples: :FREQ?
 :FREQ? MAX
 Response: NR3

Considerations:

- 1) The MIN | MAX arguments should be used only in a Program Message that does NOT contain Program Message Units specifying Arbitrary Point Rate or Wavelength, since the MAXimum or MINimum value is calculated at the time the command is parsed.
- 2) The MIN and MAX arguments refer to currently settable minimum or maximum.
- 3) FIXed is alias for CW.

Amplitude

:SOURce:VOLTage[:AMPLitude] <p-p amplitude>

The amplitude command is used to set the peak-to-peak amplitude of the output waveform. Note that the amplitude and the offset are limited by the relation
 $\text{Peak Amplitude} + |\text{Offset}| \leq 5V$

Arguments

Type: Numeric
 Units: V, mV, VPP, mVPP
 Range: 10mV to 10V
 Rounding: 1mV from 10mV to 999mV. 10mV from 1V to 10V.
 Command Type: Setting or Query
 Setting
 Syntax: [:SOURce]:VOLTage:AMPLitude<ws><amplitude>[units]
 [:SOURce]:VOLTage:AMPLitude<ws>MINimum | MAXimum
 Examples: :VOLT:AMPL 2.5
 :VOLT:AMPL 2.5V
 :VOLT:AMPL MAX
 Query
 Syntax: [:SOURce]:VOLTage:AMPLitude?

Examples: [<ws>MINimum|MAXimum]
 :VOLT:AMPL?
 :VOLT:AMPL? MAX
Response: NR2

Considerations:

- 1) The MAXimum amplitude is dependent on the offset.
- 2) The MAX and MIN arguments should not be used in a program message containing an OFFSet command, since these values are evaluated during parsing, based on the current value of the offset.

Offset

:SOURce:VOLTage:OFFSet <offset>

The offset command is used to set the DC offset of the output waveform. Note that the amplitude and the offset are limited by the relation

$$\text{Peak Amplitude} + |\text{Offset}| \leq 5V$$

Arguments

Type: Numeric
Units: V, mV
Range: 10mV to 4.99V
Rounding: to 10mV
Command Type: Setting or Query

Setting

Syntax: [:SOURce]:VOLTage:OFFSet<ws><offset>[units]
 [:SOURce]:VOLTage:OFFSet<ws>MINimum|MAXimum
Examples: :VOLT:OFFS 2.5
 :VOLT:OFFS 2.5V
 :VOLT:OFFS MAX

Query

Syntax: [:SOURce]:VOLTage:OFFSet? [<ws>MINimum|MAXimum]
Examples: :VOLT:OFFS?
 :VOLT:OFFS? MAX
Response: NR2

Considerations:

- 1) The MAXimum offset is dependent on the amplitude.
- 2) The MAX and MIN arguments should not be used in a program message containing an AMPLitude command, since these values are evaluated during parsing, based on the current value of the amplitude.

Clock Reference Source

:SOURce:REFerence:SOURce <clock source>

This command is used to select the source of the arbitrary waveform clock. This clock sets the arbitrary waveform point rate.

Arguments

Type: Character
Options: INTERNAL, EXTERNAL
Command Type: Setting or Query
Setting
Syntax: [:SOURce]: REFerence
:SOURce<ws><option>
Examples: :REF:SOUR INT
:REF:SOUR EXT

Query

Syntax: [:SOURce]: REFerence :SOURce?
Response: INT|EXT

Function

:SOURce:FUNcTion [:SHAPE]

The function command is used to set the type of waveform to be generated by the instrument.

Command Type: Setting or Query
Setting
Syntax: [:SOURce]:FUNcTion[:SHAPE]<WS><OPTION>
Examples: :FUNC SIN
:FUNC ARB

Query

Syntax: [:SOURce]:FUNcTion[:SHAPE]?
Examples: :FUNC?
Response: SIN|TRI|SQU|ARB|PUL

Considerations:

The following functions are available:
SINusoid, SQUare, TRIangle, ARBitary, PULse

AM modulation

The following sections control the AM modulation:

AM STATE

This command activates or deactivates AM modulation:

Arguments

Type: Boolean
Command Type: Setting or Query
Setting
Syntax: [:SOURce:]AM [:STATe]<ws>ON|1|OFF|0
Examples: :SOURce:AM :STAT ON
AM OFF

Query

Syntax: [:SOURce:]AM[:STATe]?
Response: 0|1

AM DEPTH

This command sets the AM modulation depth in %

Arguments

Type: Numeric
Units: none (implied %)
Range: 0 to 100
Rounding: to integer
Command Type: Setting or Query
Setting
Syntax: :SOURce:AM:DEPTH<ws><percent depth>
:SOURce:AM:DEPTH<ws>MINimum|MAXimum
Examples: AM:DEPTH 50

Query

Syntax: AM:DEPTH? [<ws>MINimum|MAXimum]
Response: NR3

AM SHAPe

This command selects the AM modulating waveform shape

Arguments

Type: Character
Options: SINusoid, TRIangle, SQUare
Command Type: Setting or Query
Setting
Syntax: [:SOURce:]AM:SHAPE<ws><SIN|TRI|SQU>
Examples: [:SOURce:]AM:SHAP SIN
AM:SHAPE TRI

Query
Syntax: [:SOURce:]AM:SHAPE?
Response: SIN|TRI|SQU

AM FREQUENCY

This command sets the AM modulating waveform frequency

Arguments

Type: Numeric.
Units: MHz, KHz, Hz (default)
Range: Fmax = 20 KHz
Fmin = 0.01 Hz
Rounding: The value is rounded to 4 digits.
Command Type: Setting or Query
Setting
Syntax: [:SOURce:]AM:FREQUENCY<ws><frequency>[units]
[:SOURce:]AM:FREQUENCY<ws>MINIMUM|MAXIMUM
Examples: AM:FREQ 5KHZ
AM:FREQ 5E3
AM:FREQ MAXIMUM
AM:FREQ MIN

Query
Syntax: [:SOURce:]AM:FREQUENCY? [<ws>MAXIMUM|MINIMUM]
Examples: AM:FREQ?
AM:FREQ? MAX
Response: NR3

AM SOURCE

This command selects the AM modulation source as either internal (then the above settings are effective) or external (and then the external waveform determines depth, shape and frequency of modulation).

Arguments

Type: Character
Options: INTERNAL, EXTERNAL
Command Type: Setting or Query
Setting
Syntax: [:SOURce:] AM:SOURCE<ws><INT|EXT>
Examples: AM:SOUR INT
AM:SOUR EXT
Query
Syntax: [:SOURce:]AM:SOURCE?
Response: INT|EXT

FM modulation

The following commands control the FM modulation:

FM STATE

This command activates or deactivates FM modulation:

Arguments

Type: Boolean
Command Type: Setting or Query
Setting
Syntax: [:SOURce:]FM[:STATe]<ws>ON | 1 | OFF | 0
Examples: FM:STAT ON
FM OFF

Query

Syntax: [:SOURce:]FM[:STATe]?
Response: 0 | 1

FM DEVIation

This command sets the FM modulation deviation

Arguments

Type: Numeric.
Units: MHz, KHz, Hz (default)
Range: Dependent on the carrier frequency.
Fmax = carrier frequency
Fmin = 10 uHz
Rounding: The value is rounded to 4 digits.
Command Type: Setting or Query
Setting
Syntax: [:SOURce:]FM:DEVIation<ws><frequency>[units]
[:SOURce:]FM:DEVIation<ws>MINimum | MAXimum
Examples: FM:DEV 5KHZ
FM:DEV 5E3
FM:DEV MAXIMUM
FM:DEV MIN

Query

Syntax: [:SOURce:]FM:DEVIation? [<ws>MAXimum | MINimum]
Examples: FM:DEV?
FM:DEV? MAX
Response: NR3

Note: The carrier frequency and deviation cannot exceed the maximum frequency limited by the instrument.

FM SHAPe

This command selects the FM modulating waveform shape

Arguments

Type:	Character
Options:	SINusoid, TRIangle, SQUare
Command Type:	Setting or Query
Setting	
Syntax:	[[:SOURce:]]FM:SHAPE<ws><SIN TRI SQU>
Examples:	[[:SOURce:]]FM:SHPE SIN FM:SHAPE TRI
Query	
Syntax:	[[:SOURce:]]FM:SHAPE?
Response:	SIN TRI SQU

FM FREQuency

This command sets the FM modulating waveform frequency

Arguments

Type:	Numeric.
Units:	MHz, KHz, Hz (default)
Range:	Fmax = 20 KHz Fmin = 0.01 Hz
Rounding:	The value is rounded to 4 digits.
Command Type:	Setting or Query
Setting	
Syntax:	[[:SOURce:]]FM:FREQuency<ws><frequency>[units] [[:SOURce:]]FM:FREQuency<ws>MINimum MAXimum
Examples:	FM:FREQ 5KHZ FM:FREQ 5E3 FM:FREQ MAXIMUM FM:FREQ MIN
Query	
Syntax:	[[:SOURce:]]FM:FREQuency? [<ws>MAXimum MINimum]
Examples:	FM:FREQ? FM:FREQ? MAX
Response:	NR3

FM SOURce

This command selects the FM modulation source as either internal (then the above settings are effective) or external (and then the external waveform determines deviation, shape and frequency of modulation).

Arguments

Type:	Character
Options:	INTernal, EXTernal
Command Type:	Setting or Query
Setting	

Syntax: [:SOURce:] FM:SOURce<ws><option>
Examples: FM:SOUR INT
FM:SOUR EXT

Query

Syntax: [:SOURce]:FM:SOURce?
Response: INT|EXT

FSK modulation

The following commands control the FSK modulation:

FSK STATE

This command activates or deactivates FSK modulation:

Arguments

Type: Boolean
Command Type: Setting or Query

Setting

Syntax: [:SOURce:]FSK[:STATE]<ws>ON|1|OFF|0
Examples: FSK:STAT ON
FM OFF

Query

Syntax: [:SOURce:]FSK[:STATE]?
Response: 0|1

FSK LOWFrequency

This command sets the lower of the two frequencies used in FSK modulation.

Arguments

Type: Numeric.
Units: MHz, KHz, Hz (default)
Range: The whole frequency range of the current function.
Rounding: The value is rounded to 4 digits.

Command Type: Setting or Query

Setting

Syntax: [:SOURce:]FSK:LOWFrequency<ws><frequency>[units]
[:SOURce:]FSK:LOWFrequency<ws>MINimum|MAXimum

Examples: FSK:LOWFrequency 5KHZ
FSK:LOWF 5E3
FSK:LOWF MAXIMUM
FSK:LOWF MIN

Query

Syntax: [:SOURce:]FSK:LOWFrequency? [<ws>MAXimum|MINimum]

Examples: FSK:LOWF?
FSK:LOWF? MAX

Response: NR3

FSK HIFrequency

This command sets the higher of the two frequencies used in FSK modulation.

Arguments

Type: Numeric.
Units: MHz, KHz, Hz (default)
Range: The whole frequency range of the current function.
Rounding: The value is rounded to 4 digits.
Command Type: Setting or Query

Setting

Syntax: [:SOURce:]FSK:HIFrequency<ws><frequency>[units]
[:SOURce:]FSK:HIFrequency<ws>MINimum | MAXimum

Examples: FSK:HIFrequency 5KHZ
FSK:HIF 5E3
FSK:HIF MAXIMUM
FSK:HIF MIN

Query

Syntax: [:SOURce:]FSK:HIFrequency? [<ws>MAXimum | MINimum]

Examples: FSK:HIF?
FSK:HIF? MAX

Response: NR3

FSK RATE

This command sets the rate of switching between the two frequencies of the modulation.

Arguments

Type: Numeric.
Units: MHz, KHz, Hz (default)
Range: Fmax = 1MHz
Fmin = 0.01Hz
Rounding: The value is rounded to 4 digits.
Command Type: Setting or Query

Setting

Syntax: [:SOURce:]FSK:RATE<ws><frequency>[units]
[:SOURce:]FSK:RATE <ws>MINimum | MAXimum

Examples: FSK:RATE 5KHZ
FSK:RATE 5E3
FSK:RATE MAXIMUM
FSK:RATE MIN

Query

Syntax: [:SOURce:]FSK:RATE ? [<ws>MAXimum | MINimum]

Examples: FSK:RATE ?
FSK:RATE ? MAX

Response: NR3

FSK SOURce

This command selects the FSK modulation source as either internal (then the above settings are effective) or external (and then the external waveform determines the frequency of modulation).

Arguments

Type: Character
Options: INTernal, EXTernal
Command Type: Setting or Query
Setting
Syntax: [:SOURce:] FSK:SOURce<ws><INT|EXT>
Examples: FSK:SOUR INT
FSK:SOUR EXT

Query

Syntax: [:SOURce:]FSK:SOURce?
Response: INT|EXT

Sweep control

The following commands control the sweep functionality:

Sweep STATE

This command activates or deactivates sweep:

Arguments

Type: Boolean
Command Type: Setting or Query
Setting
Syntax: [:SOURce:]SWEEP[:STATE]<ws>ON|1|OFF|0
Examples: SWEEP:STAT ON
SWEEP OFF

Query

Syntax: [:SOURce:]SWEEP[:STATE]?
Response: 0|1

Sweep SPACing

This command sets the sweep spacing as either LINear or LOGarithmic:

Arguments

Type: Character
Options: LINear, LOGarithmic
Command Type: Setting or Query
Setting
Syntax: [:SOURce:] SWEEP:SPACing<ws><LIN|LOG>
Examples: [:SOURce:] SWEEP:SPACing LIN
SWEEP:SPAC LOG

Query
Syntax: [:SOURce:] SWEEP:SPACing ?
Response: LIN | LOG

Sweep TIME

This command sets the time for one complete sweep:

Arguments

Type: Numeric
Units: S, mS, uS, nS
Range: 10mS to 500S
Rounding: to 4 digits
Command Type: Setting or Query

Setting

Syntax: [:SOURce:]SWEEP:TIME<ws><time>[units]
[:SOURce:]SWEEP:TIME<ws>MINimum | MAXimum

Examples: SWEEP:TIME 50MS

Query

Syntax: [:SOURce:]SWEEP:TIME? [<ws>MINimum | MAXimum]
Response: NR3

Sweep START

This command sets the start frequency of the sweep:

Arguments

Type: Numeric.
Units: MHz, KHz, Hz (default)
Range: Dependent on the frequency range of the current function.
Rounding: The value is rounded to 4 digits.
Command Type: Setting or Query

Setting

Syntax: [:SOURce:]SWEEP:START<ws><frequency>[units]
[:SOURce:]SWEEP:START<ws>MINimum | MAXimum

Examples: SWEEP:START 5KHZ
SWEEP:START 5E3
SWEEP:START MAXIMUM
SWEEP:START MIN

Query

Syntax: [:SOURce:]SWEEP:START? [<ws>MAXimum | MINimum]

Examples: SWEEP:START ?
SWEEP:START ? MAX

Response: NR3

Sweep STOP

This command sets the stop frequency of the sweep:

Arguments

Type: Numeric.
Units: MHz, KHz, Hz (default)
Range: Dependent on the frequency range of the current function.
Rounding: The value is rounded to 4 digits.
Command Type: Setting or Query

Setting

Syntax: [:SOURce:]SWEEP:STOP<ws><frequency>[units]
[:SOURce:]SWEEP:STOP<ws>MINimum | MAXimum

Examples: SWEEP:STOP 5KHZ
SWEEP:STOP 5E3
SWEEP:STOP MAXIMUM
SWEEP:STOP MIN

Query

Syntax: [:SOURce:]SWEEP:STOP? [<ws>MAXimum | MINimum]

Examples: SWEEP:STOP ?
SWEEP:STOP ? MAX

Response: NR3

Phase Adjust

[:SOURce:]PHASe<ws><phase>

This command controls the phase adjustment

Arguments

Type: Numeric
Units: one (degrees implied)
Range: -180 to +180 (other values converted to this range)
Rounding: to integer
Command Type: Setting or Query

Setting

Syntax: [:SOURce:]PHASe<ws><phase>
[:SOURce:]PHASe<ws>MINimum | MAXimum

Examples: [:SOURce:]PHASe 500

Query

Syntax: [:SOURce:]PHASe? [<ws>MINimum | MAXimum]

Response: NR3

Pulse Setting

The following commands control the pulse function:

Note that $\text{width} + 0.6 \times (\text{rise} + \text{fall}) < \text{period}$ in order to have valid values.

PULSE PERiod

This command sets the pulse period to the specified value.

Note: This also sets the pulse frequency.

Arguments

Type:	Numeric
Units:	S, mS, uS, nS
Range:	40nS-2000S
Rounding:	4 digits
Command Type:	Setting or Query
Setting	
Syntax:	[[:SOURce:]] PULse: PERiod <ws><value> [[:SOURce:]] PULse: PERiod <ws>MINimum MAXimum
Examples:	[[:SOURce:]] PULse: PERiod 500NS
Query	
Syntax:	[[:SOURce:]] PULse: PERiod? [<ws>MINimum MAXimum]
Response:	NR3

PULse WIDTH

This command pulse width to the specified value.

Arguments

Type:	Numeric
Units:	S, mS, uS, nS
Range:	20 nS minimum; maximum defined by period and transition (see note above)
Rounding:	4 digits
Command Type:	Setting or Query
Setting	
Syntax:	[[:SOURce:]] PULse: WIDTH <ws>< value > [[:SOURce:]] PULse: WIDTH <ws>MINimum MAXimum
Examples:	[[:SOURce:]] PULse: WIDTH 500NS
Query	
Syntax:	[[:SOURce:]] PULse: WIDTH? [<ws>MINimum MAXimum]
Response:	NR3

PULse EDGe

This command sets both rising and falling edge of the pulse to the specified value.

Arguments

Type:	Numeric
Units:	S, mS, uS, nS
Range:	100 nS minimum; maximum defined by period and width (see note above)
Rounding:	4 digits
Command Type:	Setting or Query
Setting	
Syntax:	[[:SOURce:]] PULse: EDGe <ws>< value > [[:SOURce:]] PULse: EDGe <ws>MINimum MAXimum
Examples:	[[:SOURce:]] PULse: EDGe 500NS
Query	

Syntax: [:SOURce:] PULse:EDGE? [<ws>MINimum | MAXimum]
Response: NR3

PULse RISE

This command sets rising edge of the pulse to the specified value.

Arguments

Type: Numeric
Units: S, mS, uS, nS
Range: 100 nS minimum; maximum defined by period and width (see note above)
Rounding: 4 digits
Command Type: Setting or Query

Setting

Syntax: [:SOURce:] PULse:RISe <ws><phase>
[:SOURce:] PULse:RISe <ws>MINimum | MAXimum

Examples: [:SOURce:] PULse:RISe 500NS

Query

Syntax: [:SOURce:] PULse:RISe? [<ws>MINimum | MAXimum]
Response: NR3

PULse FALL

This command sets falling edge of the pulse to the specified value.

Arguments

Type: Numeric
Units: S, mS, uS, nS
Range: 100 nS minimum; maximum defined by period and width (see note above)
Rounding: 4 digits
Command Type: Setting or Query

Setting

Syntax: [:SOURce:] PULse:FALl <ws><phase>
[:SOURce:] PULse:FALl <ws>MINimum | MAXimum

Examples: [:SOURce:] PULse:FALl 500NS

Query

Syntax: [:SOURce:] PULse:FALl? [<ws>MINimum | MAXimum]
Response: NR3

Duty Cycle

:SOURce:DCYClE <duty cycle value>

This command is used to set the duty-cycle of the square wave or the symmetry of triangular wave. The value is given in percent and the maximum and minimum are frequency dependent.

Arguments

Type:	Numeric
Units:	None (percent implied)
Range:	1 to 100%, depending on the Waveform and Frequency
Rounding:	to integer
Command Type:	Setting or Query
Setting	
Syntax:	:SOURce:DCYClE <ws><duty cycle value> :SOURce:DCYClE <ws>MINimum MAXimum
Query	
Syntax:	:SOURce:DCYClE? [<ws>MINimum MAXimum]
Response:	NR3

OUTPut Subsystem

The Output Subsystem controls characteristics of the source's output. Included in this subsystem are the State and Summing commands. The command structure is as follows:

```
:OUTPut  
        [:STATe] <Boolean>  
        :TERminator <Boolean>
```

Output State

```
:OUTPut [:STATe] <state 0,1>
```

This command controls whether the output is ON or OFF.

Arguments

Type:	Boolean
Command Type:	Setting or Query
Setting	
Syntax:	:OUTPut[:STATe]<ws>ON 1 OFF 0
Examples:	:OUTP:STAT ON :OUTP OFF
Query	
Syntax:	:OUTPut[:STATe]?
Response:	0 1

Output Impedance

```
:OUTPut :TERM <state 0,1>
```

This command controls whether the 50Ohm terminator is ON or OFF.

Arguments

Type: Boolean
Command Type: Setting or Query
Setting
Syntax: :OUTPut:TERM<ws>ON|1|OFF|0
Examples: :OUTP: TERM ON
:OUTP: TERM OFF
Query
Syntax: :OUTPut:TERM?
Response: 0|1

Trigger Subsystem

The Trigger Subsystem is used to control the waveform triggering. The command structure is as follows:

:TRIGger
:MODE CONTinuous|TRIGger|GATE|BURSt
:BURSt <numeric value>
:SOURce <MANual|INTernal|EXTernal|BUS
:TIMer <numeric value>

Trigger Mode

:TRIGger:MODE <trigger mode>

This command is used to set the trigger mode. It is not a standard SCPI command.

Arguments

Type: Character
Options: CONTinuous
TRIGger
GATE
BURSt
Command Type: Setting or Query
Setting
Syntax: :TRIGger:MODE<ws><option>
Examples: :TRIG:MODE CONT
:TRIG:MODE BURS
Query
Syntax: :TRIGger:MODE?
Response: CONT|TRIG|GATE|BURS

Trigger Source

:TRIGger:SOURce <trigger source>

This command is used to select the trigger source, for use in the Trigger, Gate and Burst trigger modes.

Arguments

Type: Character
Options: MANual - Front panel MAN key
BUS - GPIB trigger (GET or *TRG)
INTernal - Internal trigger
EXTernal - External trigger
Command Type: Setting or Query
Setting
Syntax: :TRIGger:SOURce<ws><option>
Examples: :TRIG:SOUR BUS
:TRIG:SOUR INT
Query
Syntax: :TRIGger:SOURce?
Response: MAN|BUS|INT|EXT

Burst Count

:TRIGger:BURSt <burst count>

Used to set the number of cycles to be output in the BURST mode. It is not a standard SCPI command.

Arguments

Type: Numeric
Range: 2 to 999999
Rounding: To integer value
Command Type: Setting or Query
Setting
Syntax: :TRIGger:BURSt<ws><value>
Examples: :TRIG:BURS 100
:TRIG:BURS MAXIMUM
Query
Syntax: :TRIGger:BURSt? [<ws>MAXimum | MINimum]
Response: NR1
Examples: :TRIG:BURST?
:TRIG:BURS? MAX

Internal Trigger Rate

:TRIGger:TIMer <trigger rate>

Sets the rate of the internal trigger.

Arguments

Type: Numeric
 Units: S, mS, uS, nS
 Range: 1E-6S to 100S
 Rounding: to 4 digits
 Command Type: Setting or Query
 Setting
 Syntax: :TRIGger:TIMer<ws><value>[units]
 :TRIGger:TIMer<ws>MINimum|MAXimum
 Examples: :TRIG:TIM 10E-6
 :TRIG:TIM MIN
 Query
 Syntax: :TRIGger:TIMer? [<ws>MINimum|MAXimum]
 Response: NR3
 Examples: :TRIG:TIM?
 :TRIG:TIM? MIN

Arbitrary Subsystem

The Arbitrary subsystem is not part of the SCPI standard. It was developed to suit the needs of the instrument. Within this subsystem are commands to:

- 1) Control the point rate, start address, wavelength, marker address, and synchronization pulse address
- 2) Set values of the arbitrary waveform, either discretely or using predefined, copy or draw functions
- 3) Protect an area of waveform memory
- 4) Set the state of the automatic update and increment features
- 5) Update the waveform

Note: There are 16,777,216 addressable memory points for models 4077B and 4080B, 4,194,304 points for models 4076B and 4079B, and 1,048,576 points for models 4075B and 4078B.

The following shows the structure of the ARbitrary subsystem:

```
:ARbitrary
  :PRATe <numeric value>
    :ADDRess <numeric value>
    :DATA <numeric value>|<arbitrary block>
    :DRAW <numeric value>,<numeric value>
    :CLEAr <numeric value>,<numeric value>
    :COPY <NRf>,<NRf>,<NRf>
    :PROTeCt
      [:RANGe] <numeric value>,<numeric value>
      :STATe <Boolean>
    :PREDeFined <shape>,<start address>,<length>,<scale>
```

```

:START <numeric value>
:LENGth <numeric value>
:MARKer
  [:ADDRes] <numeric value>
:STATe <Boolean>
:LENGth <numeric value>
:SAVe <numeric value>
:LOAD <numeric value>

```

Point Rate

```
ARBitrary:PRATe <point rate>
```

This command is used to set the point rate. It is coupled with the frequency of the waveform by the relation:

$$Frequency = \frac{1}{(Point\ Rate \times Wavelength)}$$

Thus changing the point rate will result in a change in frequency.

Arguments

Type:	Numeric
Units:	S, mS, uS, nS
Range:	5nS to 100S
Rounding:	to 4 digits
Command Type:	Setting or Query
Setting	
Syntax:	:ARBitrary:PRATe<ws><point rate>[units] :ARBitrary:PRATe<ws>MINimum MAXimum
Examples:	:ARB:PRAT 100NS
Query	
Syntax:	:ARBitrary:PRATe? [<ws>MINimum MAXimum]
Response:	NR3

Address

```
:ARBitrary:ADDRes <address>
```

This command sets the current address of the waveform. It is used to determine to where arbitrary data are to be written.

Arguments

Type:	Numeric
Range:	1 to 16,777,216
Rounding:	to integer value

Command Type: Setting or Query
 Setting
 Syntax: :ARbitrary:ADDRess<ws><address>
 :ARbitrary:ADDRess<ws>MINimum | MAXimum
 Examples: :ARB:ADDR 100
 Query
 Syntax: :ARbitrary:ADDRess? [<ws>MINimum | MAXimum]
 Response: NR1

Data

:ARbitrary:DATA <data>

This command is used to set the values of the waveform.

Arguments

Type: Numeric. Definite form arbitrary block. Indefinite form arbitrary block
 Numeric Range: -8191 to 8191 ASCII
 Rounding: to integer value
 Binary Range: 001H to 3FFFH BINARY
 Command Type: Setting or Query
 Setting Syntax
 Numeric: :ARbitrary:DATA<ws><numeric>{[,<numeric>]}
 Example :ARB:DATA 100,200,1000,2000,-2000
 Arbitrary Block: :ARbitrary:DATA<ws>#<arb block data>
 See section 4.16

Examples

Definite Form: :ARB:DATA #14\x8\x64\x8\xc8
 '\x' indicates that the values are Hexadecimal.
 Indefinite: :ARB:DATA #0\x8\x64\x8\xc8\xa^EOI
 Query
 Syntax: :ARbitrary:DATA?<ws><number of points>, BINARY|ASCII
 Response: Using the BINARY option, data are returned in the Indefinite arbitrary block form.
 Using the ASCII option, data are returned in the decimal numeric form.

Considerations:

Data cannot be written to protected memory.
 In binary form, each data point consists of two bytes.
 The high byte must precede the low byte. (big-endian order)

NOTE:

Reading waveform data:

USB: The maximum buffer size of the instrument is 32K bytes when communicating over USB. Therefore, when reading arbitrary waveform data in ASCII, it is recommended that data be read in chunks not exceeding 6000 points at a time. If read in Binary, it is recommended that data be read in chunks not exceeding 10,000 points at a time.

GPIB: The maximum buffer size is approximately 200K bytes when communicating over GPIB. For

ASCII, it is recommended that data be read in chunks not exceed 10,000 points at a time. For Binary, it is recommended that data be read in chunks not exceeding 100,000 points at a time.

Writing waveform data:

It is recommended that waveform data be sent in chunks not exceeding 10,000 points at a time when writing data into the instrument's arbitrary memory.

Line Draw

:ARbitrary:DRAW <start address>,<end address>

This command is used to generate a straight line between two points in the arbitrary waveform memory.

Arguments

Type: Numeric.
Range: 1 to 16,777,216
Rounding: to integer value
Command Type: Setting only
Setting
Syntax: :ARbitrary:DRAW<ws><start address>, <end address>
Example: :ARB:DRAW 1,1000
Considerations:

- 1) The value of the data at the start and end points must first be set by the user, using the :ARB:DATA command.
- 2) The range of the straight line cannot overlap with protected memory.
- 3) The end address must be greater than the start address.

Clear

:ARbitrary:CLEAr <start address>,<end address>

This command is used to clear all or a portion of waveform memory. The memory is the set to the value zero.

Arguments

Type: Numeric.
Numeric Range: 1 to 16,777,216
Rounding: to integer value
Command Type: Setting only
Setting
Syntax: :ARbitrary:CLEAr<ws><start address>, <end address>
Examples: :ARB:CLE 1,1000
Considerations:

- 1) The clear range cannot overlap with protected memory.
- 2) The end address must be greater than the start address.

Copy

:ARbitrary:COPY <start address>,<length>,<destination address>

This command is used to copy a section of the waveform to a different location in waveform memory.

Arguments

Type: NRf
 Range: 1 to 16,777,216
 Rounding: to integer value
 Command Type: Setting only
 Setting
 Syntax: :ARbitrary:COPY<ws><start>,<length>,<destination>
 Example: :ARB:COPY 1,1000,1001
 Considerations:

- 1) The destination range cannot overlap with protected memory.
- 2) The destination range cannot overlap with the source range.
- 3) The destination end address may not exceed the maximum address:

Start address + Length - 1 <= 16,777,216
 Destination address + Length - 1 <= 16,777,216

Memory Protection Range

:ARbitrary:PROTECT [:RANGE] <start address>,<end address>

This command is used to define a range of arbitrary waveform memory to be write-protected. The protection is effective only if the PROTECT:STATE is ON.

Arguments

Type: Numeric.
 Numeric Range: 1 to 16,777,216
 Rounding: to integer value
 Command Type: Setting or Query
 Setting
 Syntax: :ARbitrary:PROTECT[:RANGE]<ws><start>,<end>
 Examples: :ARB:PROT 1,1E3
 Query
 Syntax: :ARbitrary:PROTECT[:RANGE]?
 Response: <protect start>,<protect end> in NR1 format.

Memory Protection State

:ARbitrary:PROTECT:STATE <Boolean>

This command is used to enable or disable arbitrary waveform write-protection.

Arguments

Type: Boolean
Command Type: Setting or Query
Setting
Syntax: :ARbitrary:PROTECT:STATE<ws>ON|1|OFF|0
Example: :ARB:PROT:STAT ON
Query
Syntax: :ARbitrary:PROTECT:STATE?
Response: 0|1

Predefined waveforms

:ARB:PRED <shape>,<start address>,<length>,<scale>

This command is used to load the waveform memory with a specific type of waveform.

Arguments

Shape

Type: Character
Options: SINusoid
SQUare
TRIangle
NOISe (Pseudo-Random Noise)
ANOise (Noise added to the current waveform)
URAMp (Ramp up)
DRAMp (Ramp down)
SINXx (Sin[x]/x)
EXPUp (Exponent up)
EXPDn (Exponent down)
GAUS

Start Address

Type: Numeric. The MIN and MAX forms both set the address to 1
Range: 1 to 16,777,216
Rounding: to integer value

Length

Type: Numeric.
Range
SIN: 16 to 65,536; divisible by 4
SQU: 2 to 65,536; divisible by 2
TRI: 16 to 65,536; divisible by 4
URAM: 16 to 65,536

DRAM: 16 to 65,536
 NOIS: 16 to 65,536
 ANO: 16 to 65,536
 SINX: 16 to 65,536
 EXPU: 16 to 65,536
 EXPD: 16 to 65,536
 GAUS: 16 to 65,536
 Rounding: to integer value
 Scale
 Type: Numeric. MIN sets the scale to 1; MAX sets the scale to 100
 Range: 1 to 100 (See considerations)
 Rounding; to integer value
 Command Type: Setting only
 Setting
 Syntax: :ARbitrary:PREDefined<ws> <shape>, <start>, <length>,<scale>
 Examples: :ARB:PRED SIN,1,1e3,100
 :ARB:PRED URAM,1001,1e3,50
 Considerations:

- 1) The start address and the length must meet the specification that. Start address + Length - 1 <= 16,777,216
- 2) The 'scale' refers to the scaling of the waveform as a percentage of full scale. A scale of 100% will, under the correct conditions, generate a waveform whose data values range from -8191 to +8191. These 'correct conditions' are set by the 'offset' value. This offset is the value of the data at the start address, and determines the maximum scale settable. The following table shows the data values required in order to achieve maximum scale.

<u>SHAPE</u>	<u>DATA</u>
SIN	0
SQU	0
TRI	0
NOIS	0
URAM	-8191
DRAM	+8191
SINX	0
EXPU	-8191
EXPD	+8191
GAUS	0

Start Address

:ARbitrary:START <start address>

This command sets the start address of the waveform to be run.

Arguments

Type:	Numeric
Range:	1 to 16,777,215
Rounding:	to integer value
Command Type:	Setting or Query
Setting	
Syntax:	:ARbitrary:STARt<ws><start address> :ARbitrary:STARt<ws>MINimum MAXimum
Example:	:ARB:STAR 100
Query	
Syntax:	:ARbitrary:STARt? [<ws>MINimum MAXimum]
Examples:	:ARB:STAR? :ARB:STAR? MIN
Response:	NR1
Considerations:	The start address and length must meet the condition: $\text{Start Address} + \text{Length} - 1 \leq 16,777,216$

Wavelength

:ARbitrary:LENGth <length>

This command sets the length of the waveform being run.

Arguments

Type:	Numeric
Range:	2 to 16,777,216
Rounding:	to integer value
Command Type:	Setting or Query
Setting	
Syntax:	:ARbitrary:LENGth<ws><length> :ARbitrary:LENGth<ws>MINimum MAXimum
Example:	:ARB:LENG 1E3
Query	
Syntax:	:ARbitrary:LENGth? [<ws>MINimum MAXimum]
Example:	:ARB:LENG?
Response:	NR1
Considerations:	

- 1) Changing the wavelength will change either the frequency.
- 2) The minimum wavelength is 2.

Marker Address

:ARbitrary:MARKer [:ADDRESS] <marker address>

This command is used to set the address of the marker.

Arguments

Type: Numeric.
Range: 1 to 16,777,216
Rounding: to integer values
Setting
Syntax: :ARbitrary:MARKer[:ADDRESS]<ws><marker address>
Examples: :ARB:MARK 45

Query

Syntax: :ARbitrary:MARKer[:ADDRESS]?
Example: :ARB:MARK?
Response: Marker address in NR1 format

Considerations:

The marker is only output if its address is within the range of addresses currently being run.

Marker Length

:ARbitrary:MARKer:LENGth <numeric value>

This command is used to set the marker length. The marker length is specified by appending a numeric value, to the MARKer keyword.

Arguments

Type: Numeric
Range: 1 to 4,000
Command Type: Setting or Query
Setting
Syntax: :ARbitrary:MARKer:LENGth<ws><length>
Example: :ARB:MARK:LENG 5
Query
Syntax: :ARbitrary:MARKer:LENGth?
Response: NR1

Marker State

:ARbitrary:MARKer:STATe <Boolean>

This command is used to enable or disable the marker.

Arguments

Type: Boolean
Command Type: Setting or Query
Setting
Syntax: :ARbitrary:MARKer:STATe<ws>ON|1|OFF|0

Query
Syntax: :ARbitrary:MARKer:STATe?
Response: 0/1

Save

:ARbitrary:SAVe

This command is used to save all unsaved arbitrary waveform data into one of the non-volatile memory locations.

Arguments

Type: Numeric
Range: 1 to 8
Command Type: Setting only
Setting
Syntax: :ARbitrary:SAVe <location>

Load

:ARbitrary:LOAD

This command is used to load all arbitrary waveform data from one of the non-volatile memory locations.

Arguments

Type: Numeric
Range: 1 to 8
Command Type: Setting only
Setting
Syntax: :ARbitrary:LOAD <location>

Status Subsystem

This subsystem controls the SCPI-defined status reporting structures, which are the QUEStionable and OPERation status registers, and the error/event queue. The OPERation status registers are mandated by SCPI, and so are implemented, but are not used by the hardware. No status is ever reported through them, and they are not detailed in this manual. The following shows the STATus structure used:

```
:STATus
  :PRESet
    :QUEue
      [:NEXT]?
        :ENABle
```

:QUEStionable
:CONDition?
:PTRansition <NRf>
:NTRansition <NRf>
:EVENT?
:ENABLE <NRf>

Status Preset

:STATus:PRESet

This command is used to set certain status values to defined values.

- a) The OPERation and QUEStionable enable registers are cleared.
- b) The Positive transition filters are set to 32767.
- c) The Negative transition filters are set to 0.
- d) Only errors in the range (-440:-100) are enabled to be reported in the event queue.

Command Type: Setting only
Setting
Syntax: :STATus:PRESet

Error Queue Read

:STATus:QUEue?

This query returns the first entry in the error queue, and removes that entry from the queue. Its function is identical to that of the :SYSTem:ERRor? query.

Command Type: Query only
Query
Syntax: :STATus:QUEue[:NEXT]?
Response: <Error number>, "<error description>"

Error Queue Enable

:STATus:QUEue:ENABLE

This command is used to enable individual errors to be placed in the queue when they occur. Those errors not specified in the :ENABLE command are disabled from being reported in the error queue. Errors and events enabled to be reported at power on depends on the Power on Status Clear status (set with the *PSC common command). If PSC is set, the status is cleared on power on, and the range of errors enabled is as set by the STATus:PRESet command, ie -440 to -100. If PSC is cleared, the status is not cleared on power on, and the errors and events enabled are those that were enabled before the last power down.

Type: Expression

The expression data takes the form

(NRf|<event range>[,{NRf|<event range>}])

where NRf represents an error number. Entries are rounded to integer values.

An <event range> is defined as

NRf:NRf

The first number in a range MUST be less than the second.

Up to 6 ranges may be specified using one :ENABle command, representing the 6 ranges of errors/events. The ranges are then separated from each other by Program Data Separators (comma). The entire expression must be enclosed in parentheses(...).

Command Type: Setting or Query

Setting

Syntax: :STATus:QUEue:ENABle<ws><expression>

Example: :STAT:QUE:ENAB (-440:-410,-258:-220,402,-110)

Query

Syntax: :STATus:QUEue:ENABle?

Response: (NRf|<event range>[,{NRf|event range}])

Questionable Status

The Questionable status data structure is used to alert the user to instrument conditions that affect the signal quality. Two types of conditions are defined in the AWG, and these are:

- 1) Frequency - Trigger rate conflict, and
- 2) Output overload condition.

Each condition is reported separately for each channel. Thus, a total of four conditions may be reported.

The data structure is comprised of five 16-Bit registers. Each bit represents a different status condition. In the AWG, bits 9 and 11 are used as follows:

Bit 9: Frequency - trigger rate conflict.

Bit 11: Output overload.

The existence of these conditions is indicated in the CONDition register. Bit 3 of the status byte is used to indicate the occurrence of a questionable status condition. The conditions cause this bit to be set depending on the values of the other four registers.

The positive transition filter enables a bit in the event register to be set when a condition changes from false to true. The negative transition register enables a bit in the event register to be set when a condition changes from true to false. In order for the bit in the event register to be set, the corresponding bit in the transition register must be set.

Bit 3 in the status byte will be set if a bit in the event register is set while the corresponding bit in the enable register is set.

Questionable Condition

:STATus:QUEstionable:CONDition?

This query is used to read the condition register.

Command Type: Query only
Query
Syntax: :STATus:QUES:COND?
Response: NR1

Positive Transition Filter

:STAT:QUES:PTR

This command is used to set and query the value of the positive transition filter.

Arguments

Type: NRf
Range: 0 to 131,072. Non integer arguments are rounded before execution.
Command Type: Setting or Query
Setting
Syntax: :STAT:QUES:PTR<ws><NRf>
Examples: :STAT:QUES:PTR 2048
Query
Syntax: :STAT:QUES:PTR?
Response: NR1

Negative Transition Filter

:STAT:QUES:NTR

This command is used to set and query the value of the negative transition filter.

Arguments

Type: NRf
Range: 0 to 131,072. Non integer arguments are rounded before execution

Command Type: Setting or Query
 Setting
 Syntax: :STAT:QUES:NTR<ws><NRf>
 Examples: :STAT:QUES:NTR 2048
 Query
 Syntax: :STAT:QUES:NTR?
 Response: NR1

Event Register

:STAT:QUES:EVENT?

This query is used to read the event register. Reading the register clears it.

Command Type: Query only
 Query
 Syntax: :STATus:QUES:EVENT?
 Response: NR1

Event Enable Register

:STAT:QUES:ENABLE

This command is used to set and query the value of the enable register.

Arguments

Type: NRf
 Range: 0 to 131,072. Non integer arguments are rounded before execution.
 Command Type: Setting or Query
 Setting
 Syntax: :STAT:QUES:ENAB<ws><NRf>
 Examples: :STAT:QUES:ENAB 2048
 Query
 Syntax: :STAT:QUES:ENAB?
 Response: NR1

System Subsystem

The SYSTem subsystem collects the functions that are not related to instrument performance. The functions implemented in the AWG are security, GPIB address changing, error queue reading, SCPI version reading, and power-on buffer setting (not SCPI-defined). The command structure is as follows:

:SYSTem
 :COMMunicate

```

:GPIB
:ADDRESS <numeric value>
:ERROR?
:VERSion?
:SECurity
[:STATe] <Boolean>
:POBuffer <numeric value>

```

GPIB Address Change

```
:SYSTem:COMMunicate:GPIB:ADDRess
```

This command is used to set the GPIB address.

Arguments

```

Type:           Numeric
Range:          0 to 31
Rounding:       to integer value
Command Type:   Setting or Query

```

Setting

```
Syntax:         :SYSTem:COMMunicate:GPIB:ADDRess<ws><address> | MINimum | MAXimum
```

```
Example:        :SYST:COMM:GPIB:ADDR 20
```

Query

```
Syntax:         :SYSTem:COMMunicate:GPIB:ADDRess? [<ws>MINimum | MAXimum]
```

```
Response:       <address> in NR1 format
```

Considerations:

- 1) Setting the address to 31 puts the instrument in the off-bus state.
- 2) Using the MAX option sets the address to 30, not 31.

Default Power-on is address 9.

Error Queue Reading

```
:SYSTem:ERRor?
```

This query returns the first entry in the error queue, and removes that entry from the queue. It's function is identical to that of the :STATus:QUEue:NEXT? query.

```
Command Type:   Query only
```

Query

```
Syntax:         :SYSTem:ERRor?
```

```
Response:       <Error number>, "<error description>"
```

SCPI Version

```
:SYSTem:VERSion?
```

This query is used to read the SCPI version to which the instrument complies.

Command Type: Query only
Query
Syntax: :SYSTem:VERSion?
Response: 1992.0 (NR2 format)

Security

:SYSTem:SECurity[:STATe] <Boolean>

This command enables the instrument memory to be cleared. The stored settings and the arbitrary waveform memory are cleared when the Security state is changed from ON to OFF. The instrument state is returned to the factory power-on default.

Arguments

Type: Boolean
Command Type: Setting or Query
Setting
Syntax: :SYSTem:SECurity[:STATe]<ws>ON|1|OFF|0
Examples: :SYST:SEC ON
:SYST:SEC OFF

Query

Syntax: :SYSTem:SECurity[:STATe]?
Response: 0|1

Power-on Buffer

:SYSTem:POBuffer <buffer number>

This command is used to set the Power On Buffer setting. The instrument will power-on with the setting stored in that buffer.

Arguments

Type: Numeric
Range: 0 to 49
Rounding: to integer value
Command Type: Setting or Query
Setting
Syntax: :SYSTem:POBuffer<ws><buffer>|MINimum|MAXimum
Example: :SYST:POB 49
Query
Syntax: :SYSTem:POBuffer? [<ws>MINimum|MAXimum]
Response: Power-on buffer in NR1 format

4.14 IEEE 488.1 Interface Messages

GET - Group Execute Trigger

The GET is used by the AWG as a trigger when it is in either the TRIGGER, GATE or BURST modes, with the trigger source set to BUS. It has the same effect as the *TRG common command.

DCL - Device Clear

In response to the DCL, the AWG does the following:

- a) Clears the input buffer and the output queue.
- b) Resets the Message Processing Functions.

SDC - Selected Device Clear

The response is as for the DCL message, when device is addressed to listen.

LLO - Local Lockout

Sending LLO when device is addressed to listen and controller is asserting the REN line will put the device into "Remote with Lock out" state, locking out the front panel.

:TRIGger Subsystem

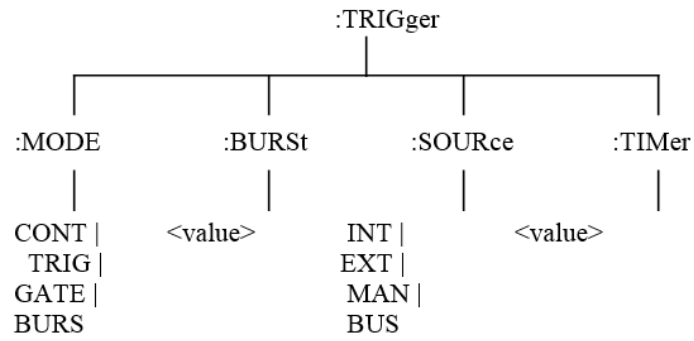

:ARBitrary Subsystem

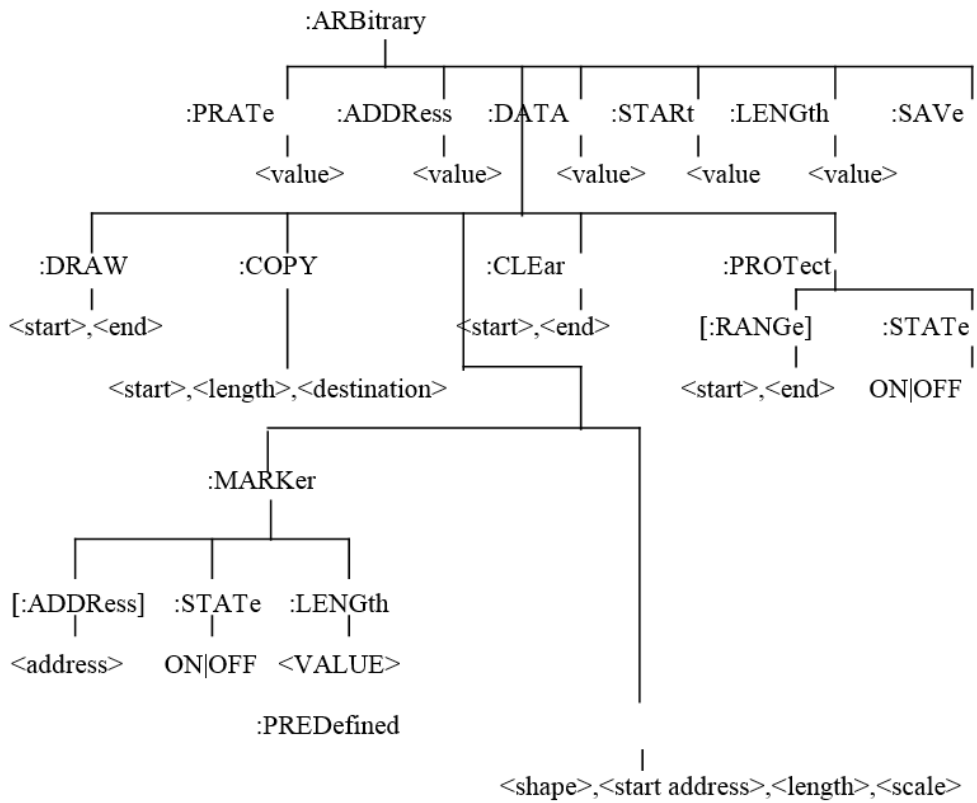

:STATus Subsystem

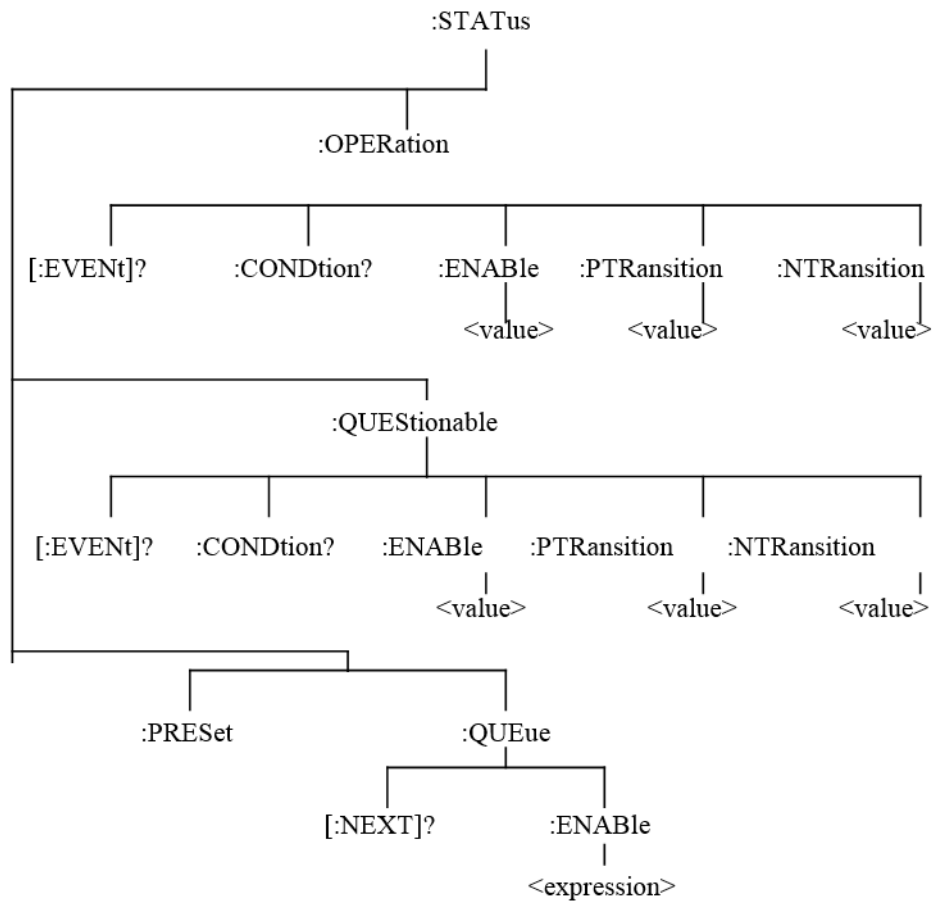

:SYSTem Subsystem

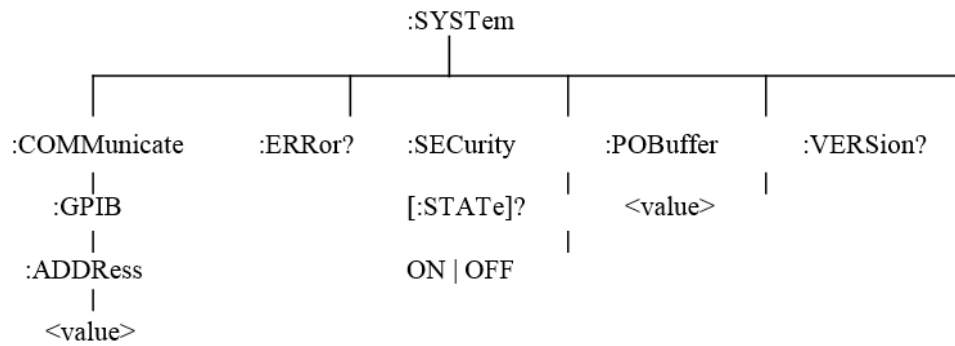

Hex	Oct	Dec	ASCII	Msg	Hex	Oct	Dec	ASCII	Msg
00	000	0	NUL		20	040	32	SP	MLA0
01	001	1	SOH	GTL	21	041	33	!	MLA1
02	002	2	STX		22	042	34	"	MLA2
03	003	3	ETX		23	043	35	#	MLA3
04	004	4	EOT	SDC	24	044	36	\$	MLA4
05	005	5	ENQ	PPC	25	045	37	%	MLA5

06	006	6	ACK		26	046	38	&	MLA6
07	007	7	BEL		27	047	39	'	MLA7
08	010	8	BS	GET	28	050	40	(MLA8
09	011	9	HT	TCT	29	051	41)	MLA9
0A	012	10	LF		2A	052	42	*	MLA10
0B	013	11	VT		2B	053	43	+	MLA11
0C	014	12	FF		2C	054	44	,	MLA12
0D	015	13	CR		2D	055	45	-	MLA13
0E	016	14	SO		2E	056	46	.	MLA14
0F	017	15	SI		2F	057	47	/	MLA15
10	020	16	DLE		30	060	48	0	MLA16
11	021	17	DC1	LLO	31	061	49	1	MLA17
12	022	18	DC2		32	062	50	2	MLA18
13	023	19	DC3		33	063	51	3	MLA19
14	024	20	DC4	DCL	34	064	52	4	MLA20
15	025	21	NAK	PPU	35	065	53	5	MLA21
16	026	22	SYN		36	066	54	6	MLA22
17	027	23	ETB		37	067	55	7	MLA23
18	030	24	CAN	SPE	38	070	56	8	MLA24
19	031	25	EM	SPD	39	071	57	9	MLA25
1A	032	26	SUB		3A	072	58	:	MLA26
1B	033	27	ESC		3B	073	59	;	MLA27
1C	034	28	FS		3C	074	60	<	MLA28
1D	035	29	GS		3D	075	61	=	MLA29
1E	036	30	RS		3E	076	62	>	MLA30
1F	037	31	US		3F	077	63	?	UNL

Message Definitions

DCL	Device Clear	MSA	My Secondary Address
GET	Group Execute Trigger	MTA	My Talk Address
GTL	Go To Local	PPC	Parallel Poll Configure
LLO	Local Lockout	PPD	Parallel Poll Disable
MLA	My Listen Address		

Hex	Oct	Dec	ASCII	Msg	Hex	Oct	Dec	ASCII	Msg
40	100	64	@	MTA0	60	140	96	`	MSA0,PPE
41	101	65	A	MTA1	61	141	97	a	MSA1,PPE
42	102	66	B	MTA2	62	142	98	b	MSA2,PPE
43	103	67	C	MTA3	63	143	99	c	MSA3,PPE
44	104	68	D	MTA4	64	144	100	d	MSA4,PPE
45	105	69	E	MTA5	65	145	101	e	MSA5,PPE
46	106	70	F	MTA6	66	146	102	f	MSA6,PPE
47	107	71	G	MTA7	67	147	103	g	MSA7,PPE
48	110	72	H	MTA8	68	150	104	h	MSA8,PPE
49	111	73	I	MTA9	69	151	105	i	MSA9,PPE

4A	112	74	J	MTA10	6A	152	106	j	MSA10,PPE
4B	113	75	K	MTA11	6B	153	107	k	MSA11,PPE
4C	114	76	L	MTA12	6C	154	108	l	MSA12,PPE
4D	115	77	M	MTA13	6D	155	109	m	MSA13,PPE
4E	116	78	N	MTA14	6E	156	110	n	MSA14,PPE
4F	117	79	O	MTA15	6F	157	111	o	MSA15,PPE
50	120	80	P	MTA16	70	160	112	p	MSA16,PPD
51	121	81	Q	MTA17	71	161	113	q	MSA17,PPD
52	122	82	R	MTA18	72	162	114	r	MSA18,PPD
53	123	83	S	MTA19	73	163	115	s	MSA19,PPD
54	124	84	T	MTA20	74	164	116	t	MSA20,PPD
55	125	85	U	MTA21	75	165	117	u	MSA21,PPD
56	126	86	V	MTA22	76	166	118	v	MSA22,PPD
57	127	87	W	MTA23	77	167	119	w	MSA23,PPD
58	130	88	X	MTA24	78	170	120	x	MSA24,PPD
59	131	89	Y	MTA25	79	171	121	y	MSA25,PPD
5A	132	90	Z	MTA26	7A	172	122	z	MSA26,PPD
5B	133	91		MTA27	7B	173	123	{	MSA27,PPD
5C	134	92	\	MTA28	7C	174	124		MSA28,PPD
5D	135	93		MTA29	7D	175	125	}	MSA29,PPD
5E	136	94	^	MTA30	7E	176	126	~	MSA30,PPD
5F	137	95	_	UNT	7F	177	127	DEL	

Message Definitions

PPE	Parallel Poll Enable	SPE	Serial Poll Enable
PPU	Parallel Poll Unconfigure	TCT	Take Control
SDC	Selected Device Clear	UNL	Unlisten
SPD	Serial Poll Disable	UNT	Untalk

4.16 Block Transfer (GPIB only)

Arbitrary waveform data sent in IEEE488.2 arbitrary block format may take two forms: the definite form and the indefinite form. The essential difference between these forms is that the definite form contains a byte count, while the indefinite form does not. In both cases, the format of the command is

```
:ARB:DATA<ws><preamble><data><terminator>.
```

The <data> represents the arbitrary waveform data. This field consists of 8 bit bytes sent in hexadecimal form. Each arbitrary data point consists of two bytes with the high byte being sent first. When sending data in this way, the value of a data point may range from -8191, corresponding to the negative peak, to 8191, corresponding to the positive peak. The value 0 corresponds to zero baseline. Compare the ASCII, or front panel representation, which defines data in the range - 8191to + 8191.

Example: to set a data value to zero, send the Hex bytes

0000

The definite form <preamble> consists of two fields. The first is a single byte representing the number of digits in the byte count. The byte count is the second field in the preamble, and consists of decimal bytes (0-9), which, when taken together, give the byte count.

Example of definite form (sending values 0,1,2 decimal):

```
:ARB:DATA #16\x0\x0\x0\x1\x0\x2
```

means that the byte count consists of 1 byte only, and the number of bytes is 6. (Note: '\x' refers to Hexadecimal) The indefinite form preamble consists of a 0 character alone.

Example of indefinite form (same data as above):

```
:ARB:DATA #0\x0\x0\x0\x1\x0\x2\x0A
```

Since it does not contain a byte count, the indefinite form command must be terminated with EOI if using GPIB or CR and/or LF when using RS232 interface. (Note: '\x0A' is the hexadecimal value for LF) Since each arbitrary data point consists of two bytes, an even number of bytes must be sent. In the following examples, the data is specified in Hex format with each byte being preceded by '\x', in order to show this.

Example of definite form:

```
:ARB:DATA #16\x8\x0\x8\x1\x8\x2
```

Here, the byte count consists of one byte only, and the value is 6.

Example to definite form:

```
:ARB:DATA #0\x8\x0\x8\x1\x8\x2\x0A
```

The '\x0A' represents the Linefeed character. EOI must be sent with this character. Arbitrary data read from the instrument in binary form, as opposed to ASCII, are returned in indefinite form. Before sending your data enable all errors to be reported, using

```
:STAT:QUEUE:ENABLE ALL.
```

Then, if the arb data command causes an error, the error message may be read from the queue using the query.

```
:SYST:ERR?
```

4.17 GPIB Communication Protocol

General

This appendix describes the effects of interface messages on waveform generator operation and uses abbreviations from the IEEE Standard 488.1-1987.

Responses to IEEE-488.1 Interface Messages

Interface messages and the effects of those messages on the instrument interface functions are defined in IEEE Standard 488.1-1987. Where appropriate, the GPIB code is listed, in decimal.

UNL-Unlisten (63 with ATN)

UNT-Untalk (95 with ATN)

The UNL command places the listener function to its idle (unaddressed) state. In this idle state, the waveform generator cannot accept commands from the GPIB.

The UNT command places the talker function to its idle state. In this idle state, the waveform generator cannot output data through the GPIB.

When the talker and listener functions are idle, the front-panel ADRS indicator is off. If the waveform generator is talk-addressed or listen-addressed, the ADRS indicator lights.

IFC-Interface Clear (Bus pin 9)

The IFC message places both the listener and talk functions to idle states. When the talker and listener functions are idle, the front-panel ADRS indicator is off.

The IFC pulse is $\geq 100\mu\text{s}$.

DCL-Device Clear (20 with ATN)

The Device Clear message resets GPIB communication. That is, the DCL message clears all input and output messages, as well as all unexecuted settings.

SDC-Selected Device Clear (4 with ATN)

The SDC message causes the same response as the DCL message. However, the waveform generator only responds if it is listen-addressed.

GET-Group Execute Trigger (8 with ATN)

The waveform generator responds to the Group Execute Trigger message only if it is listen addressed and the device trigger function is enabled. The TRIGger:MODE must be in TRIG, CONTinuous, or BURst and the TRIGger:SOURce must be set to BUS to enable device triggering via GET.

SPE-Serial Poll Enable (24 with ATN)

The SPE message generates output serial poll status bytes when talk-addressed.

SPD-Serial Poll Disable (25 with ATN)

The SPD message switches back to generating output data from the Output Buffer.

MLA-My Listen Address (GPIB Address + 32)

MTA-My Talk Address (GPIB Address + 64)

The instrument GPIB primary address establishes the listen and talk addresses. To see the current GPIB primary address, press SPECIAL and then F1:SYS on the front panel. When the waveform generator is talk-addressed or listen-addressed, the front-panel ADRS indicator lights.

LLO-Local Lockout (17 with ATN)

When the waveform generator is listen addressed, the LLO message changes the waveform generator to the front-panel lockout state.

REN-Remote Enable (GPIB pin 17)

REN is normally held true by the controller and allows the controller to then put the waveform generator into one of the remote states. Pulsing REN false or holding it false forces the device into local state (LOCS).

NOTE

If you disconnect and reconnect the GPIB cable when the controller is holding REN true, the REN goes false and the device got to local state (LOCS).

GTL-Go To Local (1 with ATN)

Listen-addressed instruments respond to GTL by changing to a local state. Remote-to-local transitions

caused by GTL do not affect the execution of the message being processed when GTL was received.

Remote-Local Operation

Most front-panel controls cause a transition from REMS to LOCS by asserting a message called return-to-local (rtl). This transition can occur during message execution. However, in contrast to TGL and REN transitions, a transition initiated by rtl affects message execution. In this case, the waveform generator generates an error if there are any unexecuted setting or operational commands.

Front-panel controls that change only the display, do not affect the remote-local states. Only front-panel controls that change settings assert rtl. The rtl message remains asserted when you enter multiple keystroke settings from the front panel, and is unasserted after you execute the settings changes. Since rtl prevents transition to REMS, the waveform generator unasserts rtl if you do not complete a multiple key sequence in a reasonable length of time (about 5 to 10 seconds).

A record of the front-panel settings is in the Current Settings Buffer; however, new settings entered from the front panel or the controller update these recorded settings. In addition, the front panel updates to reflect setting changes from controller commands. Settings are unaffected by transitions among the 4 remote-local states. The REMOTE indicator lights when the waveform generator is in REMS or RWLS.

Local State (LOCS)

When in a local state (LOCS), you control the settings through the front-panel controls. In addition, only GPIB query commands are executed. All other GPIB commands setting and operational prompt and error since those commands are under front-panel (local) control.

NOTE

The waveform generator can be in either Local State (LOCS) or Remote State (REMS) when it receives the Local Lockout (LLO) interface message. If in LOCS and REN is asserted, the waveform generator enters the Local With Lockout State (LWLS) or, if in REMS, it enters the Remote With Lockout State (RWLS) when it receives LLO. The controller controls the LWLS and RWLS state transitions.

Local Without Lockout State (LWLS)

When the waveform generator is in a local without lockout state (LWLS), it operates the same as it does in LOCS. However, in LWLS rtl does not inhibit a transition to remote state.

Remote State (REMS)

When the waveform generator is in a remote state (REMS), you control its operations from the

controller. All settings update when GPIB are executed.

Remote With Lockout State (RWLS)

When in a remote with lockout state (RWLS), the waveform generator operates much the same as it does in LOCS. However, when in RWLS the waveform generator ignores the rtl message, locking out any changes made from the front panel.

IEEE 488.2 Interface Function Subsets

IEEE Standard 488.2 identifies the interface function repertoire of a device on the bus in terms of interface function subsets. These subsets are defined in the standard. Table C-1 lists the subsets that apply to the waveform generator.

Table 4.1 - Interface Function Subsets

FUNCTION	SUBSET	CAPABILITY
Source Handshake	SH1	Complete capability
Acceptor Handshake	AH1	Complete capability
Basic Talker	T6	Responds to Serial Poll, Untalk if My Listen Address (MLA) is received
Basic Listener	L4	Unlisten if My Talk Address (MTA) is received
Service Request	SR1	Complete capability
Remote-Local	RL1	Complete capability, including Local Lockout (LLO)
Parallel Poll	PP0	Does not respond to Parallel Poll
Device Clear	DC1	Complete capability
Device Trigger	DT1	Complete capability
Controller	C0	No controller functions
Electrical Interface	E2	Three-state drive capability

5 Troubleshooting Guide

Below are some frequently asked questions and answers. Please check if any apply to your instrument before contacting B&K Precision.

Q: I cannot power up the generator

- Check that the power cord is securely connected to the AC input and there is live power from your electrical AC outlet.
- Verify that the AC power coming from the mains is the correct voltage. The generator can accept a specific range of AC input voltages. Refer to section “2.1 Input Power Requirements”.

Q: I do not get any output from the output terminals

- Make sure that the **On** button(s) above channel 1 and/or channel 2 BNC connectors are lit. If not, press it once to toggle the output option **ON**. The backlight of these output channel buttons indicates that the respective channel’s output is enabled.

Q: I have connected my signal to an oscilloscope, but the amplitude is double of what I set

- This is often because the impedance of the generator is not matched with the oscilloscope. When the generator is set to 50 Ω impedance, connecting it directly to an oscilloscope with a 1 M Ω input impedance will cause this to happen. To eliminate this issue, connect a 50 Ω terminator to the input of the oscilloscope, then connect a BNC cable between the generator and the terminator to have matching impedance. Refer to section “2.2 Output Connections”.

Q: My two signals are out of phase even after I press the sync phase button.

- Check that the two cables being used are the same impedances. At higher frequencies, impedances of the cables play a factor in the signal integrity.
- Check that the two cables being used are the same exact lengths. At higher frequencies, different length cables will cause phase delay issues between the two channels.

6 Specifications

Note: All specifications apply to the unit after a temperature stabilization time of 15 minutes over an ambient temperature range of 23 °C ± 5 °C. Specifications are subject to change without notice.

Model	4075B	4078B	4076B	4079B	4077B	4080B
Channels	1	2	1	2	1	2
Max. frequency	30 MHz		50 MHz		80 MHz	
Waveforms						
Standard	Sine, Square, Triangle/Ramp, Pulse					
Built-in arbitrary	Sine, Triangle, Square, Noise, Ramp Up, Ramp Down, Sine(X)/X, Exponential Up, Exponential Down, Gaussian					
User-defined arbitrary	1 Mpts per ch		4 Mpts per ch		16 Mpts per ch	
Operating Modes & Modulation Types						
Operating modes	Continuous, Triggered, Burst, Gated					
Modulation types	AM, FM, FSK					
Sine						
Frequency range	1 μHz to 30 MHz		1 μHz to 50 MHz		1 μHz to 80 MHz	
Resolution	1 μHz, up to 12 digits					
Amplitude flatness (relative to 1 kHz)						
$f_{OUT} \leq 1$ MHz	± 0.2 dB					
$f_{OUT} \leq 50$ MHz	± 1.0 dB					
$f_{OUT} \leq 80$ MHz	± 2.0 dB					
Harmonic distortion (typical)						
$f_{OUT} \leq 100$ kHz (10 Hz - 100 kHz)	-65 dBc					
$f_{OUT} \leq 5$ MHz (100 kHz - 5 MHz)	-45 dBc					
$f_{OUT} \leq 80$ MHz (5 MHz - 80 MHz)	-35 dBc					
Spurious						
$f_{OUT} \leq 1$ MHz (DC - 1 MHz)	-60 dBc					
$f_{OUT} < 20$ MHz (1 MHz - 20 MHz)	-50 dBc					
Phase noise (at 10 MHz instrument frequency)						
10 kHz offset	-110 dBc/Hz					
Square						
Frequency range (Square)	1 μHz to 30 MHz		1 μHz to 50 MHz		1 μHz to 60 MHz	
Rise & Fall time	< 5 ns (10% to 90%) at full amplitude into 50 Ω					
Duty Cycle	20% to 80% to 10 MHz 40% to 60% to 30 MHz 50% > 30 MHz					
Asymmetry (50% duty cycle)	1% of period ± 5 ns					

Aberrations	< 5% + 50 mV		
Jitter	< 70 ps rms (typical)		
Ramp & Triangle			
Frequency range	1 μ Hz to 5 MHz		
Resolution	1 μ Hz, up to 12 digits		
Symmetry	1 uHz to 500 kHz: 0%-100% 500 kHz to 2 MHz: 10%-90% 50% > 2 MHz		
Linearity	<0.1% of peak output (1 μ Hz to 250 kHz)		
Pulse			
Frequency range	1 MHz to 25 MHz		
Resolution	1 μ Hz		
Pulse width	20 ns minimum, 10 ns resolution, 999 s max		
Variable edge time	<5 ns (Fast setting) to pulse period ⁽¹⁾		
Jitter	< 50 ps rms (typical)		
Arbitrary Waveform Characteristics			
Waveform Length	2 points to 1,048,576 points	2 points to 4,194,304 points	2 points to 16,777,216 points
Sampling Rate	200 MSa/s, point execution rate adjustable from 5 ns – 100 s		
Vertical Resolution	14 bits (16,384 levels)		
Noise	Add 1% to 100% to output arbitrary waveform		
Bandwidth	100 MHz max (2-point waveform length)		
Frequency	Accuracy: \pm 0.002% Resolution: 4 digits or 1 ps		
Rise and Fall Time	< 5 ns (typical)		
Jitter	< 50 ps rms (typical)		
Output Characteristics			
Signal Output			
Output Impedance	50 Ω typical		
Output Protection	Protected against short circuit or accidental voltage applied to the main output connector ⁽²⁾		
Amplitude			
Range	10 mV to 10 Vp-p into 50 Ω		
Resolution	4 digits (9999 counts)		
Units	Vpp, Vrms, or dBm		
Accuracy	\pm 1% \pm 20 mV of the programmed output value from 1 V – 10 V \pm 1% \pm 1 mV of the programmed output value from 50 mV – 999 mV		
DC Offset			
Range	\pm 4.99 Vpk into 50 Ω		
Resolution	1 mV with 4 digits resolution		
Units	VDC		
Accuracy	\pm 1% \pm 10 mV into 50 Ω		
Frequency			

Accuracy	± 10 ppm for DDS, ± 20 ppm for Arbitrary	
Phase	-180 to +180 degrees with 0.1 degree resolution	
Modulation Characteristics		
Amplitude Modulation (AM)		
Carrier	Sine, Square, or Triangle	
Source	Internal, External	
Internal Modulation	0.01 Hz – 20 kHz	
Depth	0% to 100%	
Frequency Modulation (FM)		
Carrier	Sine, Square, or Triangle	
Source	Internal, External	
Internal Modulation	0.01 Hz – 20 kHz	
Deviation	1 uHz to max frequency/2	
Frequency-shift Keying (FSK)		
Carrier	Sine, Square, or Triangle	
Source	Internal, External	
Rate	≤ 1 MHz	
Sweep Characteristics		
Sweep Shape	Linear and Logarithmic, up or down	
Sweep Time	10 ms to 500 s	
Sweep Trigger	Internal, External, Continuous, or Burst	
Burst Characteristics		
Waveforms	Sine, Square, Triangle, Pulse, Arb	
Count	1-999,999 cycles	
Trigger Source	Manual, Internal, External	
Inputs and Outputs		
Trigger IN	TTL Compatible Maximum rate: 20 MHz Minimum width: 20 ns Input impedance: 10 kΩ nominal	
Sync OUT	TTL pulse at programmed frequency, 50 Ω impedance	
Modulation IN	5 Vp-p for 100% modulation 10 kΩ input impedance DC to 50 kHz bandwidth	
Marker OUT	Positive TTL pulse, user programmable in arbitrary waveform, 50 Ω impedance	
External Reference OUT	10 MHz clock for synchronization, TTL, 50 Ω impedance	
External Reference IN	10 MHz from an external source, >1 kΩ impedance	
Internal Trigger		
Repetition	1 μs to 100 s (0.01 Hz – 1 MHz)	
Resolution	4 digits	
Accuracy	± 0.002%	
General		
Display Resolution	400 × 240 dots	
Remote Interface	USB (USBTMC-	USB (USBTMC-compliant) and GPIB

	compliant)	
Storage Memory	50 full panel settings at power-off, including last working setup	
Dimensions (W x H x D)	213 mm x 88 mm x 300 mm (8.4" x 3.5" x 12")	
Weight	3 kg	
AC Input	100-240 V \pm 10 %, 50-60 Hz \pm 5% (< 40 VA)	
Temperature	0°C to +50°C (operating) -20°C to +70°C (non-operating)	
Humidity	95% RH, 0°C to 30°C 75% RH to 40°C 45% RH to 50°C	
EMC	According to EN55011 for radiated and conducted emissions	
Electrical Discharge Immunity	According to EN55082	
Safety Specifications	According to EN61010, CE approved	

- (1) Depending on pulse width.
- (2) Output turns off automatically when an overload is applied. The instrument can tolerate shorts to ground indefinitely.

SERVICE INFORMATION

Warranty Service: Please go to the support and service section on our website at www.bkprecision.com to obtain a RMA #. Return the product in the original packaging with proof of purchase to the address below. Clearly state on the RMA the performance problem and return any leads, probes, connectors and accessories that you are using with the device.

Non-Warranty Service: Please go to the support and service section on our website at www.bkprecision.com to obtain a RMA #. Return the product in the original packaging to the address below. Clearly state on the RMA the performance problem and return any leads, probes, connectors and accessories that you are using with the device. Customers not on an open account must include payment in the form of a money order or credit card. For the most current repair charges please refer to the service and support section on our website.

Return all merchandise to B&K Precision Corp. with prepaid shipping. The flat-rate repair charge for Non-Warranty Service does not include return shipping. Return shipping to locations in North America is included for Warranty Service. For overnight shipments and non-North American shipping fees please contact B&K Precision Corp.

B&K Precision Corp.
22820 Savi Ranch Parkway
Yorba Linda, CA 92887
www.bkprecision.com
714-921-9095

Include with the returned instrument your complete return shipping address, contact name, phone number and description of problem.

LIMITED THREE-YEAR WARRANTY

B&K Precision Corp. warrants to the original purchaser that its products and the component parts thereof, will be free from defects in workmanship and materials for a period of **three years** from date of purchase.

B&K Precision Corp. will, without charge, repair or replace, at its option, defective product or component parts. Returned product must be accompanied by proof of the purchase date in the form of a sales receipt.

To help us better serve you, please complete the warranty registration for your new instrument via our website www.bkprecision.com

Exclusions: This warranty does not apply in the event of misuse or abuse of the product or as a result of unauthorized alterations or repairs. The warranty is void if the serial number is altered, defaced or removed.

B&K Precision Corp. shall not be liable for any consequential damages, including without limitation damages resulting from loss of use. Some states do not allow limitations of incidental or consequential damages. So the above limitation or exclusion may not apply to you.

This warranty gives you specific rights and you may have other rights, which vary from state-to-state.

B&K Precision Corp.
22820 Savi Ranch Parkway
Yorba Linda, CA 92887
www.bkprecision.com
714-921-9095

BK PRECISION[®]

22820 Savi Ranch Parkway
Yorba Linda, CA 92887
www.bkprecision.com

© 2014 B&K Precision Corp.