

THESE DRAWINGS ARE THE PROPERTY OF QUALTEK ELECTRONICS AND NOT TO BE REPRODUCED FOR OR COMMUNICATED TO A THIRD PARTY WITHOUT THE EXPRESS WRITTEN PERMISSION OF AN OFFICER OF QUALTEK ELECTRONICS.

REVISION			
REV.	DESCRIPTION	DATE	APPROVED
B	RoHS Compliancy	06-01-06	DP
C	Updated Graphics and Dimensions	05-21-10	LY
D	Material Update	04-15-13	LY

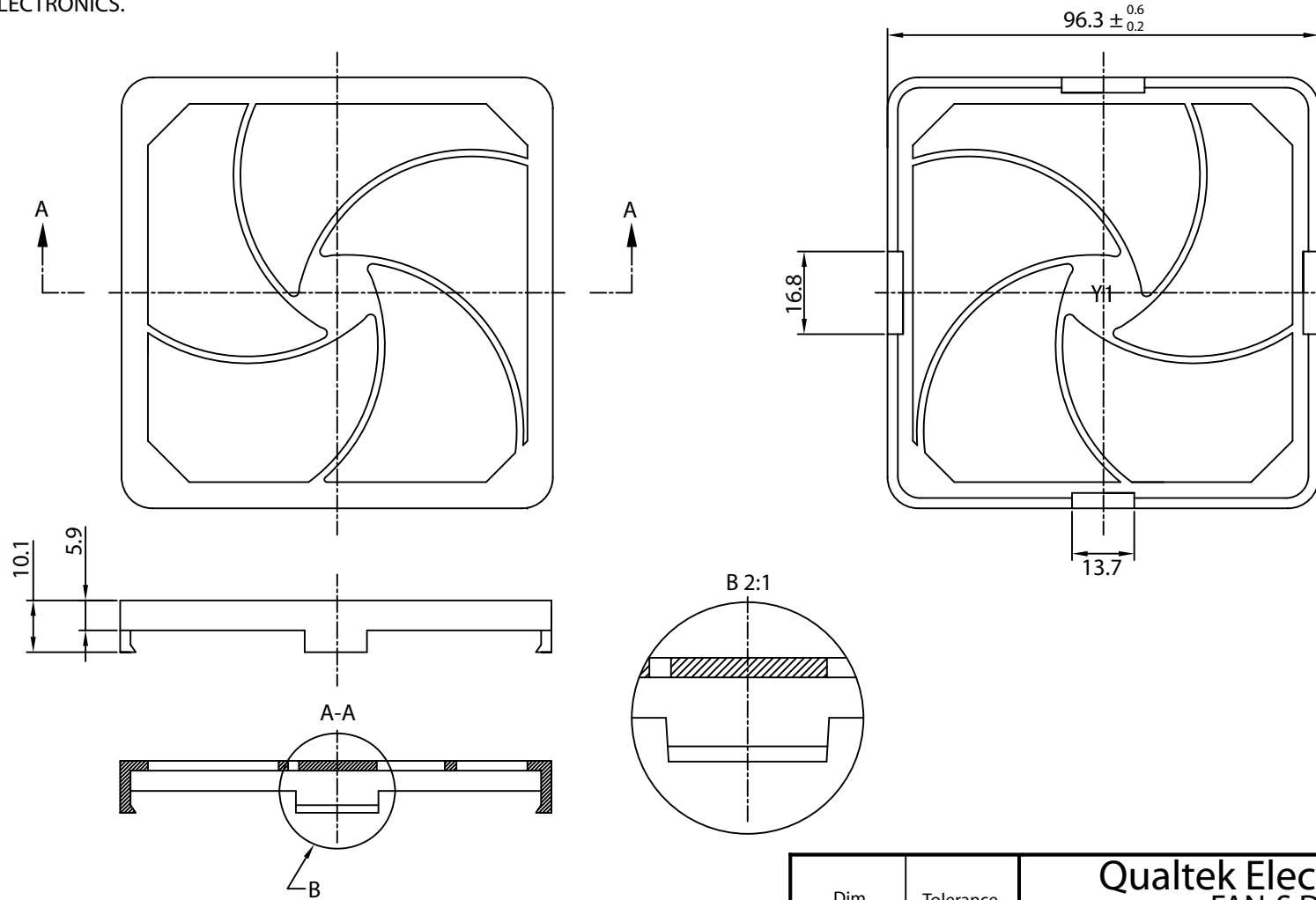

CONTROLLED

NOTES:

MATERIAL: PC 2805
UL94V-2
RoHS COMPLIANT

Dim range (mm)	Tolerance +/- (mm)	Qualtek Electronics Corp. FAN-S DIVISION		
		Part Number:	09362-R	RoHS Compliant
0-5	0.1	Description: PLASTIC FAN RETAINER		
5-16	0.15			
16-64	0.2	UNIT: mm	REV: D	
64-250	0.4	Drawn / Date	Checked / Date	Approved / Date
250-1000	0.5	B.ZHANG 10-10-03	10-10-03	JJH / 10-10-03
1000-1500	1.0			