

NTGD1100L, STGD1100L

Power MOSFET

8 V, ±3.3 A, Load Switch with Level-Shift, P-Channel, TSOP-6

The NTGD1100L integrates a P and N-Channel MOSFET in a single package. This device is particularly suited for portable electronic equipment where low control signals, low battery voltages and high load currents are needed. The P-Channel device is specifically designed as a load switch using ON Semiconductor state-of-the-art trench technology. The N-Channel, with an external resistor (R1), functions as a level-shift to drive the P-Channel. The N-Channel MOSFET has internal ESD protection and can be driven by logic signals as low as 1.5 V. The NTGD1100L operates on supply lines from 1.8 to 8.0 V and can drive loads up to 3.3 A with 8.0 V applied to both V_{IN} and $V_{ON/OFF}$

Features

- Extremely Low $R_{DS(on)}$ Load Switch MOSFET
- Level Shift MOSFET is ESD Protected
- Low Profile, Small Footprint Package
- V_{IN} Range 1.8 to 8.0 V
- ON/OFF Range 1.5 to 8.0 V
- ESD Rating of 2000 V
- These Devices are Pb-Free and are RoHS Compliant

MAXIMUM RATINGS ($T_J = 25^\circ\text{C}$ unless otherwise noted)

Rating		Symbol	Value	Unit	
Input Voltage (V_{DSS} , P-Ch)		V_{IN}	8.0	V	
ON/OFF Voltage (V_{GS} , N-Ch)		$V_{ON/OFF}$	8.0	V	
Continuous Load Current (Note 1)	Steady State	I_L	$T_A = 25^\circ\text{C}$	±3.3	A
			$T_A = 85^\circ\text{C}$	±2.4	
Power Dissipation (Note 1)	Steady State	P_D	$T_A = 25^\circ\text{C}$	0.83	W
			$T_A = 85^\circ\text{C}$	0.43	
Pulsed Load Current	$tp = 10 \mu\text{s}$	I_{LM}	±10	A	
Operating Junction and Storage Temperature		T_J, T_{STG}	-55 to 150	$^\circ\text{C}$	
Source Current (Body Diode)		I_S	-1.0	A	
ESD Rating, MIL-STD-883D HBM (100 pF, 1.5 kΩ)		ESD	2.0	kV	
Lead Temperature for Soldering Purposes (1/8" from case for 10 s)		T_L	260	$^\circ\text{C}$	

Stresses exceeding those listed in the Maximum Ratings table may damage the device. If any of these limits are exceeded, device functionality should not be assumed, damage may occur and reliability may be affected.

1. Surface-mounted on FR4 board using 1 in sq pad size (Cu area = 1.127 in sq [1 oz] including traces).



ON Semiconductor®

www.onsemi.com

$V_{(BR)DSS}$	$R_{DS(on)}$ TYP	I_D MAX
8.0 V	40 mΩ @ -4.5 V	±3.3 A
	55 mΩ @ -2.5 V	
	80 mΩ @ -1.8 V	

SIMPLIFIED SCHEMATIC

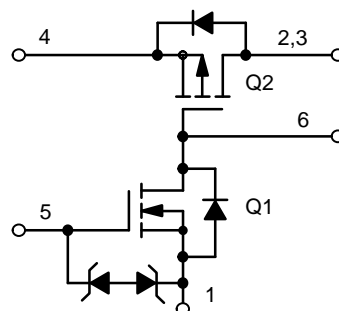

MARKING DIAGRAM & PIN ASSIGNMENT



1
TSOP-6
CASE 318G
STYLE 11

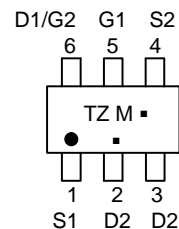

TZ = Specific Device Code
M = Date Code*
▪ = Pb-Free Package

(Note: Microdot may be in either location)

*Date Code orientation may vary depending upon manufacturing location.

ORDERING INFORMATION

Device	Package	Shipping†
NTGD1100LT1G	TSOP-6 (Pb-Free)	3000 / Tape & Reel
STGD1100LT1G	TSOP-6 (Pb-Free)	3000 / Tape & Reel

†For information on tape and reel specifications, including part orientation and tape sizes, please refer to our Tape and Reel Packaging Specification Brochure, BRD8011/D.

NTGD1100L, STGD1100L

THERMAL RESISTANCE RATINGS

Rating	Symbol	Max	Unit
Junction-to-Ambient – Steady State (Note 2)	$R_{\mu JA}$	150	°C/W
Junction-to-Foot – Steady State (Note 2)	$R_{\mu JF}$	50	

2. Surface-mounted on FR4 board using 1 in sq pad size (Cu area = 1.127 in sq [1 oz] including traces).

ELECTRICAL CHARACTERISTICS ($T_J = 25^\circ\text{C}$ unless otherwise noted)

Characteristic	Symbol	Test Condition	Min	Typ	Max	Unit
OFF CHARACTERISTICS						
Q2 Drain-to-Source Breakdown Voltage	V_{IN}	$V_{GS2} = 0\text{ V}, I_{D2} = -250\ \mu\text{A}$	8.0			V
Forward Leakage Current	I_{FL}	$V_{GS1} = 0\text{ V}, V_{DS1} = 8.0\text{ V}$	$T_J = 25^\circ\text{C}$		1.0	μA
			$T_J = 125^\circ\text{C}$		10	
Q2 Gate-to-Source Leakage Current	I_{GSS}	$V_{DS2} = 0\text{ V}, V_{GS2} = \pm 8.0\text{ V}$			± 100	nA
Q2 Diode Forward On-Voltage	V_{SD}	$I_S = -1.0\text{ A}, V_{GS2} = 0\text{ V}$		-0.7	-1.0	V

ON CHARACTERISTICS

Voltage ON/OFF	$V_{ON/OFF}$		1.5		8.0	V	
Q1 Gate Threshold Voltage	V_{GS1}	$V_{GS1} = V_{DS1}, I_D = 50\ \mu\text{A}$	0.6		1.2	V	
Input Voltage	V_{IN}	$V_{GS2} = V_{DS2}, I_D = 250\ \mu\text{A}$	1.8		8.0	V	
Q2 Drain-to-Source On Resistance	$R_{DS(on)}$	$V_{ON/OFF} = 1.5\text{ V}, I_L = 1.0\text{ A}$	$V_{IN} = 4.5\text{ V}$		40	55	$\text{m}\Omega$
			$V_{IN} = 2.5\text{ V}$		55	70	
			$V_{IN} = 1.8\text{ V}$		80	140	
Load Current	I_L	$V_{DROPP} \leq 0.2\text{ V}, V_{ON/OFF} = 1.5\text{ V}$	$V_{IN} = 5.0\text{ V}$	1.0			A
			$V_{IN} = 2.5\text{ V}$	1.0			
			$V_{IN} = 1.8\text{ V}$	1.0			

Product parametric performance is indicated in the Electrical Characteristics for the listed test conditions, unless otherwise noted. Product performance may not be indicated by the Electrical Characteristics if operated under different conditions.

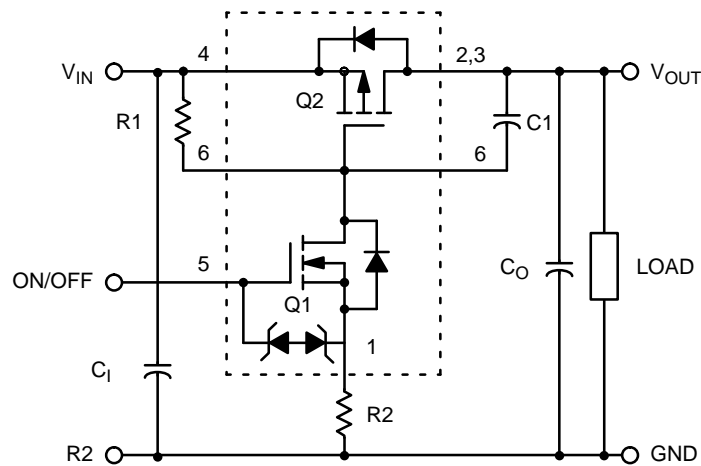

Figure 1. Load Switch Application

Components	Description	Values
R1	Pullup Resistor	Typical 10 k Ω to 1.0 M Ω
R2	Optional Slew-Rate Control	Typical 0 to 100 k Ω
C0	Output Capacitance	Usually < 1.0 μF
C1	Optional In-Rush Current Control	Typical $\leq 1000\ \text{pF}$

NTGD1100L, STGD1100L

TYPICAL CHARACTERISTICS

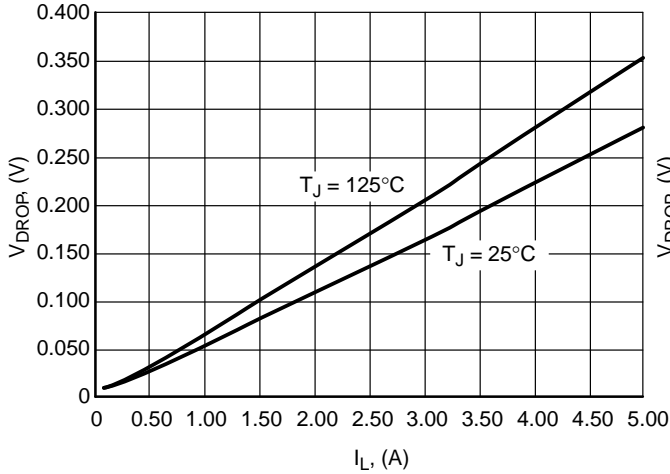

Figure 2. V_{DROP} vs. I_L @ $V_{IN} = 2.5$ V

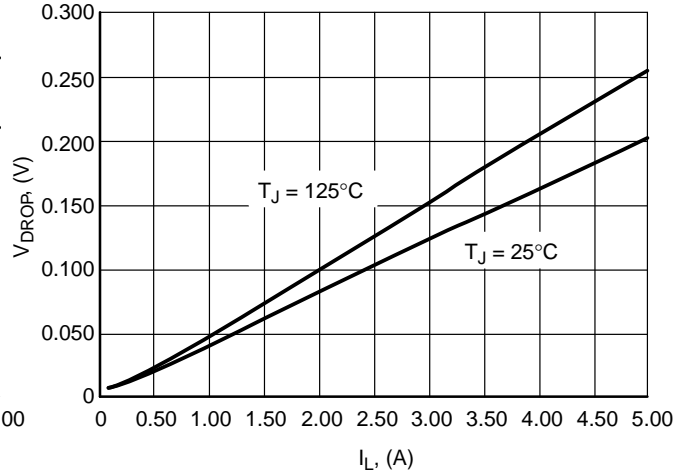

Figure 3. V_{DROP} vs. I_L @ $V_{IN} = 4.5$ V

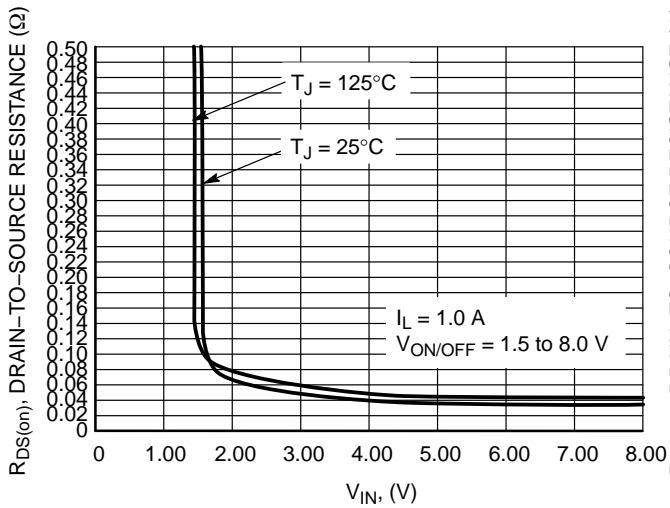

Figure 4. On Resistance vs. Input Voltage

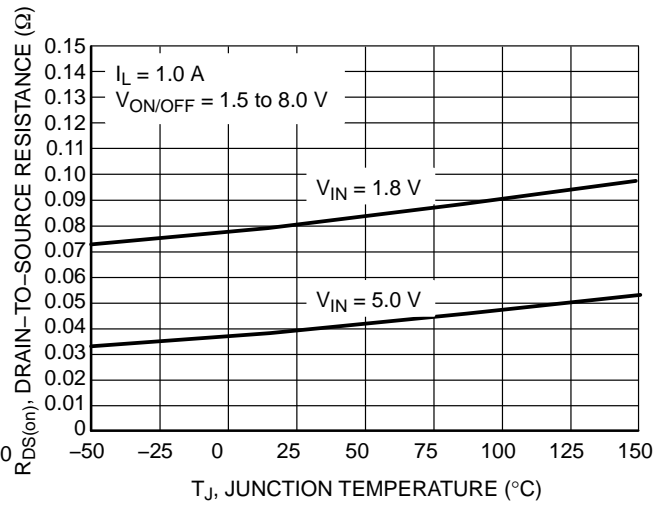

Figure 5. On Resistance Variation with Temperature

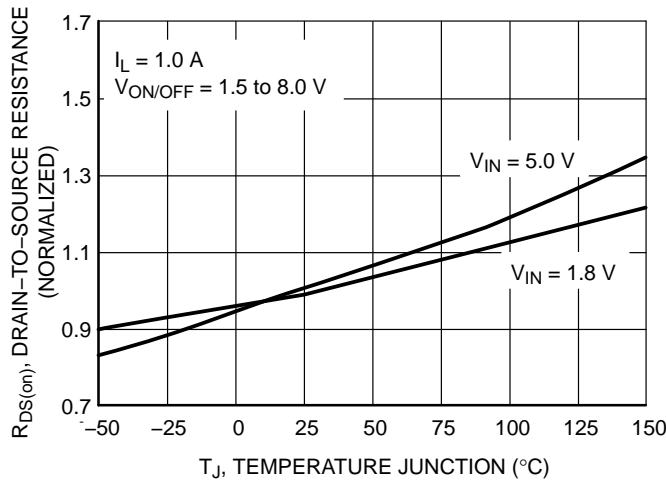

Figure 6. Normalized On Resistance Variation with Temperature

NTGD1100L, STGD1100L

TYPICAL CHARACTERISTICS

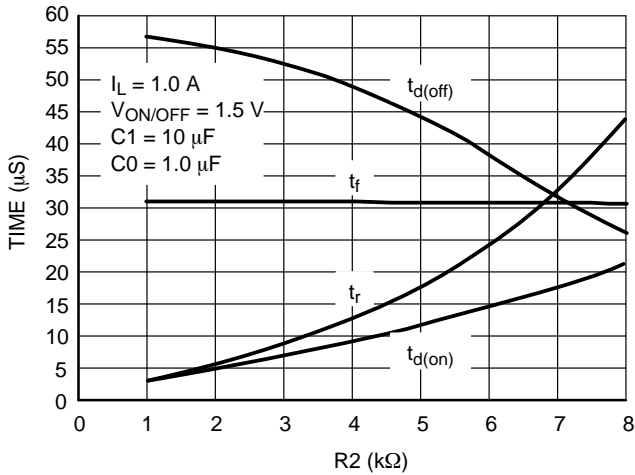

Figure 7. Switching Variation R2 @
 $V_{IN} = 4.5 \text{ V}, R_1 = 20 \text{ k}\Omega$

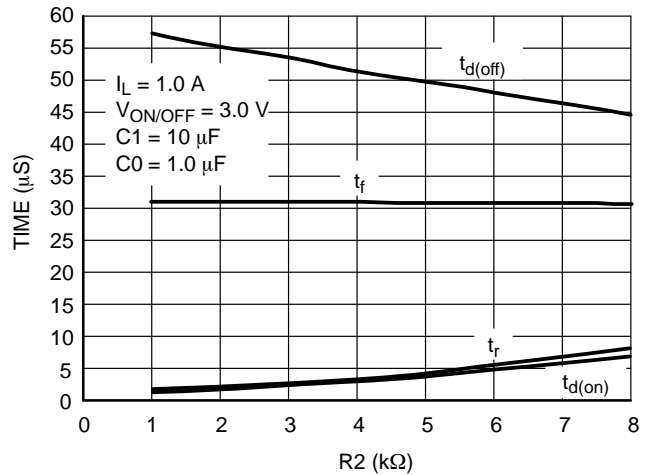

Figure 8. Switching Variation R2 @
 $V_{IN} = 4.5 \text{ V}, R_1 = 20 \text{ k}\Omega$

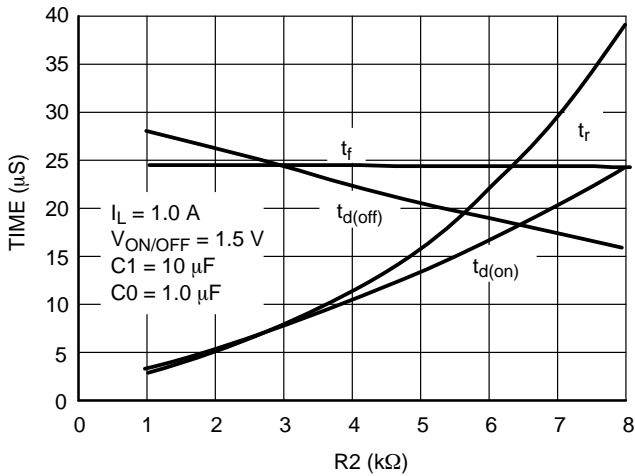

Figure 9. Switching Variation R2 @
 $V_{IN} = 2.5 \text{ V}, R_1 = 20 \text{ k}\Omega$

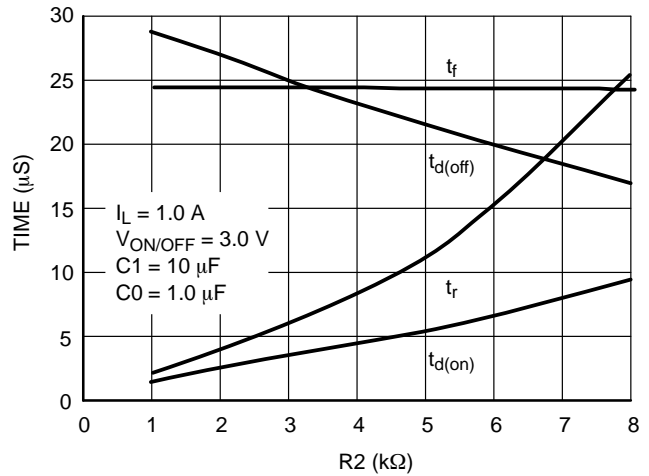

Figure 10. Switching Variation R2 @
 $V_{IN} = 2.5 \text{ V}, R_1 = 20 \text{ k}\Omega$

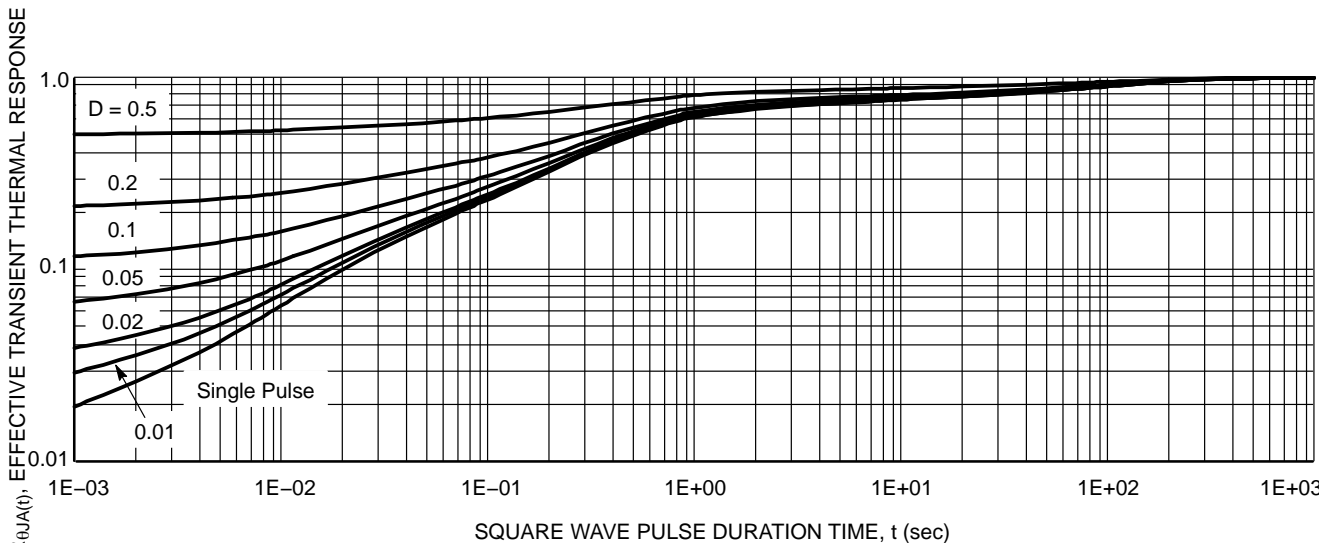
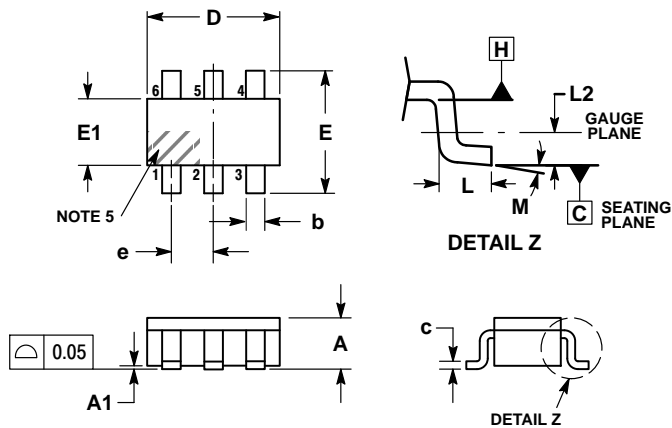

Figure 11. FET Thermal Response Normalized to $R_{\theta JA}$ at Steady State (1 inch Pad)

NTGD1100L, STGD1100L

PACKAGE DIMENSIONS

TSOP-6 CASE 318G-02 ISSUE V



NOTES:

1. DIMENSIONING AND TOLERANCING PER ASME Y14.5M, 1994.
2. CONTROLLING DIMENSION: MILLIMETERS.
3. MAXIMUM LEAD THICKNESS INCLUDES LEAD FINISH. MINIMUM LEAD THICKNESS IS THE MINIMUM THICKNESS OF BASE MATERIAL.
4. DIMENSIONS D AND E1 DO NOT INCLUDE MOLD FLASH, PROTRUSIONS, OR GATE BURRS. MOLD FLASH, PROTRUSIONS, OR GATE BURRS SHALL NOT EXCEED 0.15 PER SIDE. DIMENSIONS D AND E1 ARE DETERMINED AT DATUM H.
5. PIN ONE INDICATOR MUST BE LOCATED IN THE INDICATED ZONE.

DIM	MILLIMETERS		
	MIN	NOM	MAX
A	0.90	1.00	1.10
A1	0.01	0.06	0.10
b	0.25	0.38	0.50
c	0.10	0.18	0.26
D	2.90	3.00	3.10
E	2.50	2.75	3.00
E1	1.30	1.50	1.70
e	0.85	0.95	1.05
L	0.20	0.40	0.60
L2	0.25 BSC		
M	0°	-	10°

STYLE 11:

1. SOURCE 1
2. DRAIN 2
3. DRAIN 2
4. SOURCE 2
5. GATE 1
6. DRAIN 1/GATE 2

RECOMMENDED SOLDERING FOOTPRINT*

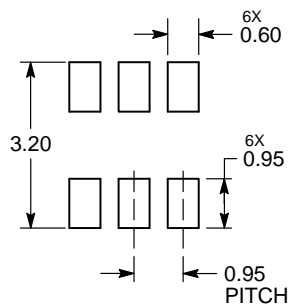

DIMENSIONS: MILLIMETERS

*For additional information on our Pb-Free strategy and soldering details, please download the ON Semiconductor Soldering and Mounting Techniques Reference Manual, SOLDERRM/D.

ON Semiconductor and the are registered trademarks of Semiconductor Components Industries, LLC (SCILLC) or its subsidiaries in the United States and/or other countries. SCILLC owns the rights to a number of patents, trademarks, copyrights, trade secrets, and other intellectual property. A listing of SCILLC's product/patent coverage may be accessed at www.onsemi.com/site/pdf/Patent-Marking.pdf. SCILLC reserves the right to make changes without further notice to any products herein. SCILLC makes no warranty, representation or guarantee regarding the suitability of its products for any particular purpose, nor does SCILLC assume any liability arising out of the application or use of any product or circuit, and specifically disclaims any and all liability, including without limitation special, consequential or incidental damages. "Typical" parameters which may be provided in SCILLC data sheets and/or specifications can and do vary in different applications and actual performance may vary over time. All operating parameters, including "Typicals" must be validated for each customer application by customer's technical experts. SCILLC does not convey any license under its patent rights nor the rights of others. SCILLC products are not designed, intended, or authorized for use as components in systems intended for surgical implant into the body, or other applications intended to support or sustain life, or for any other application in which the failure of the SCILLC product could create a situation where personal injury or death may occur. Should Buyer purchase or use SCILLC products for any such unintended or unauthorized application, Buyer shall indemnify and hold SCILLC and its officers, employees, subsidiaries, affiliates, and distributors harmless against all claims, costs, damages, and expenses, and reasonable attorney fees arising out of, directly or indirectly, any claim of personal injury or death associated with such unintended or unauthorized use, even if such claim alleges that SCILLC was negligent regarding the design or manufacture of the part. SCILLC is an Equal Opportunity/Affirmative Action Employer. This literature is subject to all applicable copyright laws and is not for resale in any manner.

PUBLICATION ORDERING INFORMATION

LITERATURE FULFILLMENT:

Literature Distribution Center for ON Semiconductor
19521 E. 32nd Pkwy, Aurora, Colorado 80011 USA
Phone: 303-675-2175 or 800-344-3860 Toll Free USA/Canada
Fax: 303-675-2176 or 800-344-3867 Toll Free USA/Canada
Email: orderlit@onsemi.com

N. American Technical Support: 800-282-9855 Toll Free
USA/Canada
Europe, Middle East and Africa Technical Support:
Phone: 421 33 790 2910
Japan Customer Focus Center
Phone: 81-3-5817-1050

ON Semiconductor Website: www.onsemi.com

Order Literature: <http://www.onsemi.com/orderlit>

For additional information, please contact your local Sales Representative