

SPECIFICATION

- Part No. : **ISPC.86A.09.0092E**
- Product Name : 5dBi ISM Band 865-870Mhz Embedded Ceramic Patch Antenna with Cable and Connector
- Features : High antenna efficiency
868MHz ISM Band
5dBi Peak (when placed on 30cm x30cm ground plane) - Broadside to Zenith Radiation Pattern
1dBi Peak Gain in free-space
47.5*47.5*6.5mm (Ceramic Antenna)
49.5*49.5*7.5mm (Antenna with EVB)
RG178 92mm cable length
MMCX Male Right Angle Connector
RoHS Compliant

Photo:

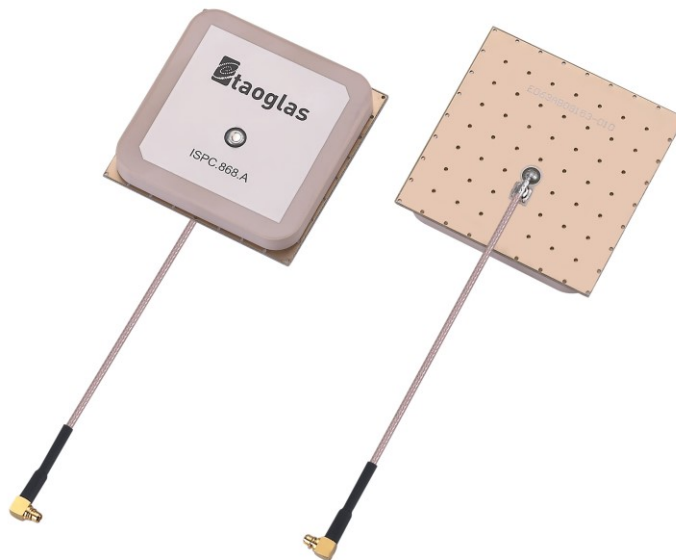

1. Introduction

The 5dBi ISPC.86A antenna is designed primarily for compact fixed wireless applications in the 865MHz to 870MHz frequency range where extra coverage range is required. The antenna functions best when the backside is placed on a metal panel.

When placed on a reference 30cm square ground-plane, the antenna has excellent directional hemispherical radiation pattern up to 5dBi on the zenith, and an efficiency of 65%.

Even without a ground-plane underneath the antenna achieves 1dBi and an efficiency of 40~50%, with an omnidirectional pattern.

This ceramic patch antenna with RG178 and MMCX male right angle connector is a great solution for the following typical applications

- RFID Readers
- Short range 868MHz mesh networks

Cable type, length and connector can be customized. Mechanical customization can also be done for a minimum order quantity. Please contact your regional Taoglas office for more details.

2. Specification

ELECTRICAL		
Measurement environment	Free Space	On 30*30cm ground plane
Operation Frequency (MHz)	865 to 870MHz	
Return Loss (dB)	-6.3	-6.7
Peak Gain (dbi)	0.37	4.63
Efficiency (%)	46.09	61.84
Average Gain (dB)	-3.36	-2.09
Polarization	Linear	
Impedance	50 Ohms	
Radiation Properties	Broadside Toward Zenith	
Max Input Power	5 W	
MECHANICAL		
Dimension (mm)	47.5*47.5*6.5	
Material	Ceramic	
Product Dimension (mm)	49.5*49.5*7.5	
Coaxial Cable	RG178	
Coaxial Length (mm)	92	
Connector	MMCX Male Right Angle	
ENVIRONMENTAL RATINGS		
Operation Temperature	-40°C to 85°C	
Storage Temperature	-40°C to 105°C	
Relative Humidity	40% to 95%	
RoHs Compliant	Yes	

3. Antenna Characteristics

3.1 Testing setup

ISPC.86A antenna was tested with R&S ZNB-8 network analyzer.

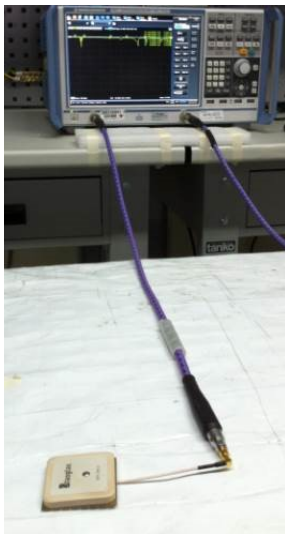

Free Space

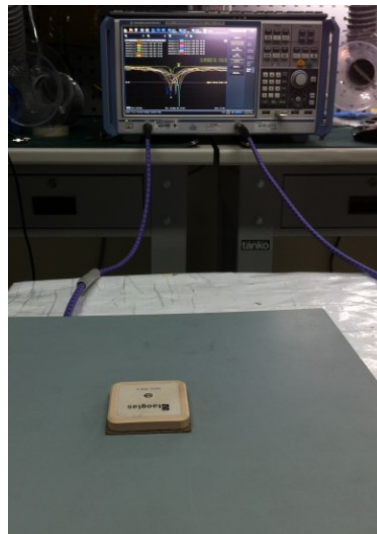

On 30x30(cm) metal plane

3.2 Return Loss

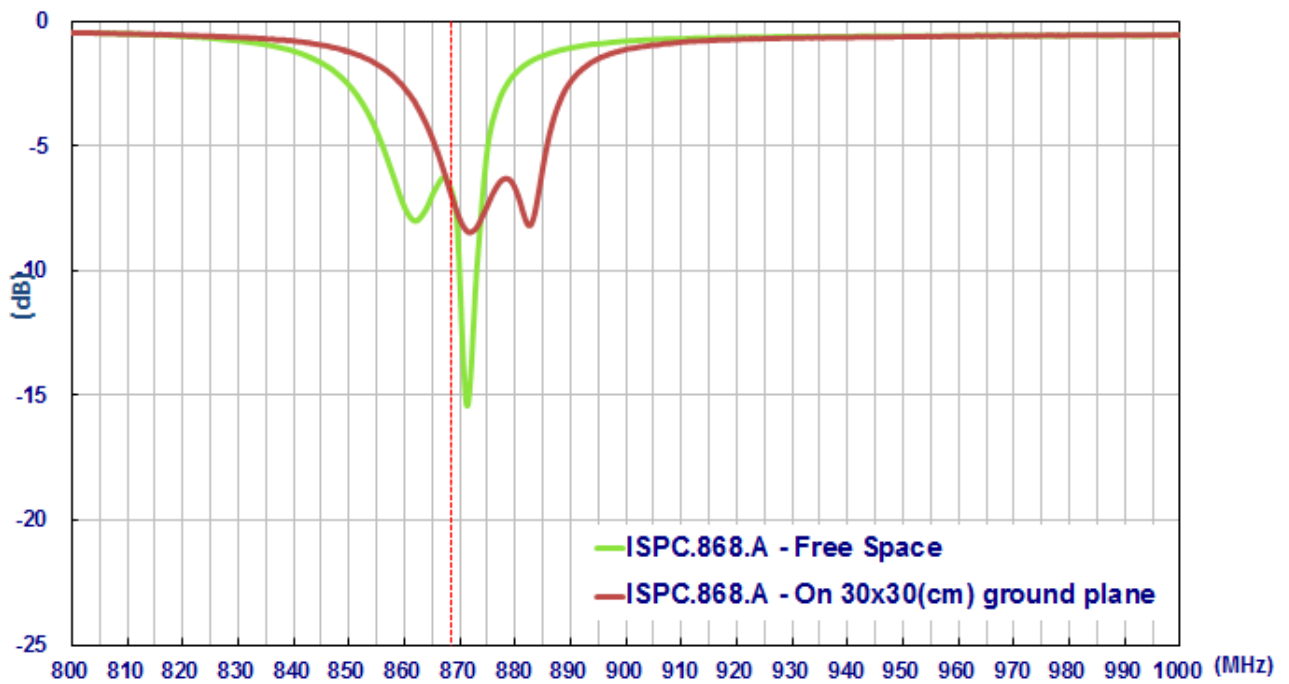

3.3 Peak Gain

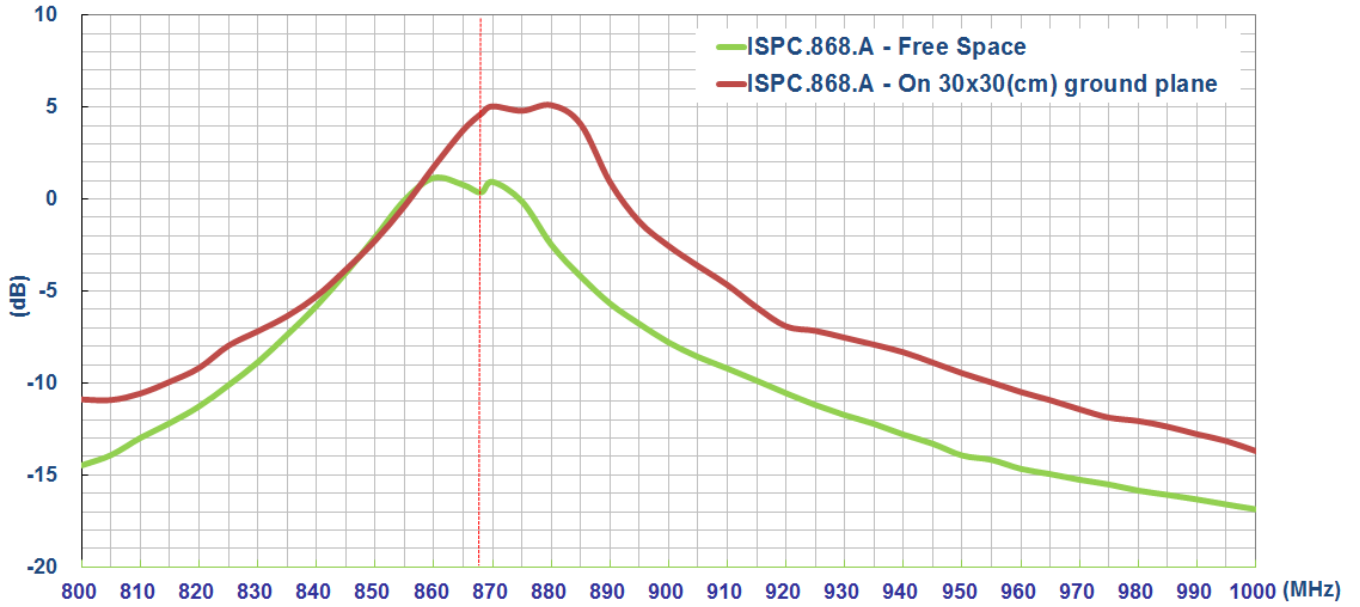

3.4 Efficiency

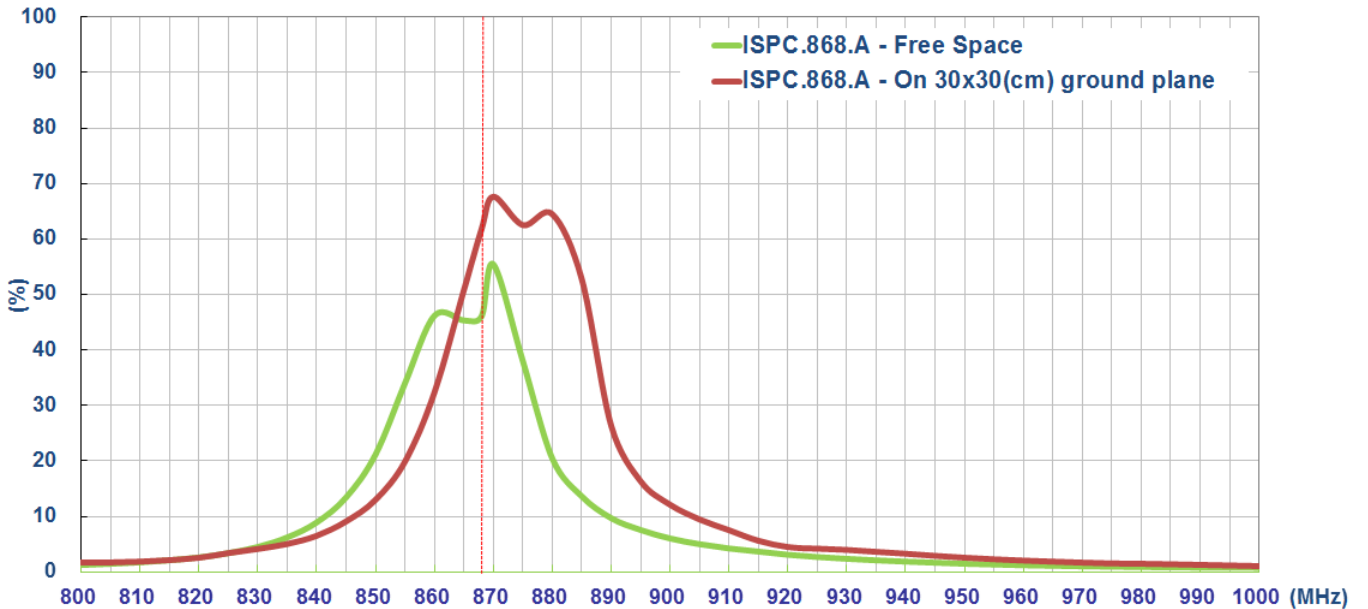

3.5 Average Gain

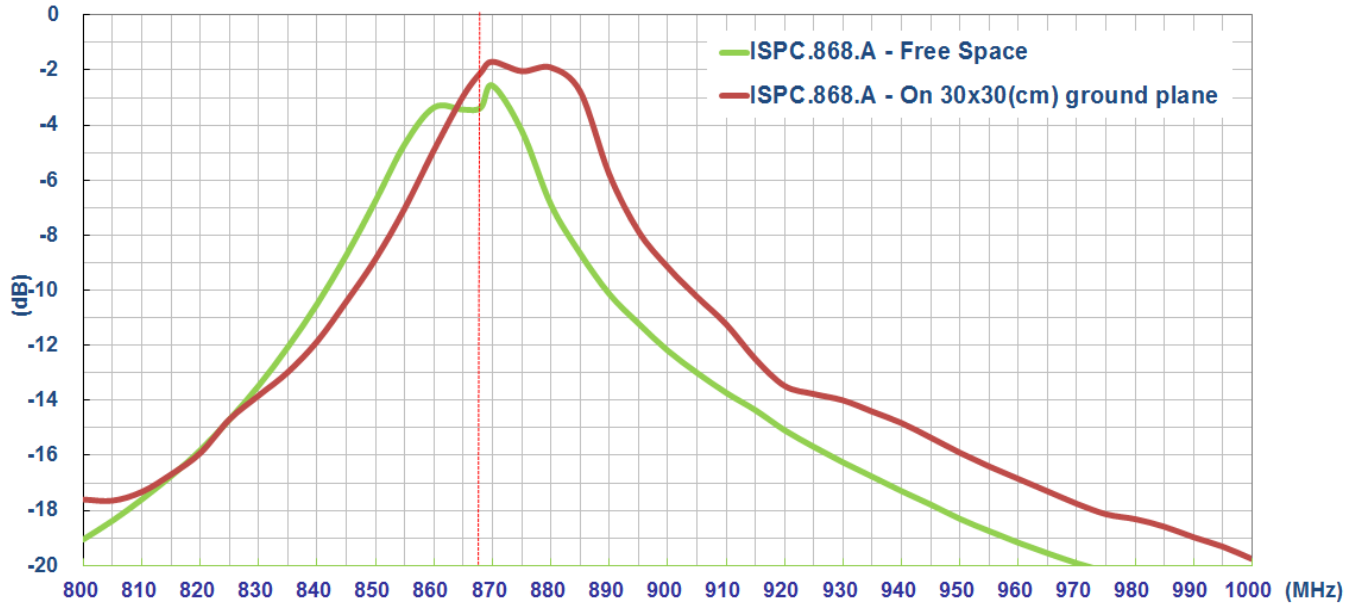

4. Antenna Radiation Patterns

4.1 Antenna setup

The antenna radiation pattern measured setup as shown the below,

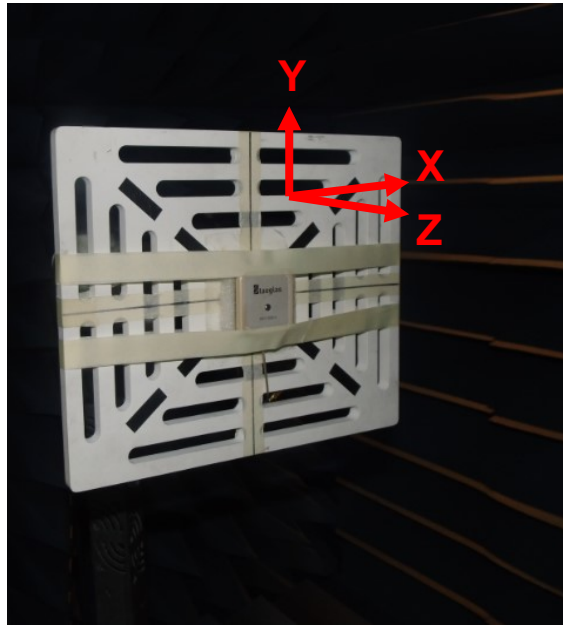

Free Space

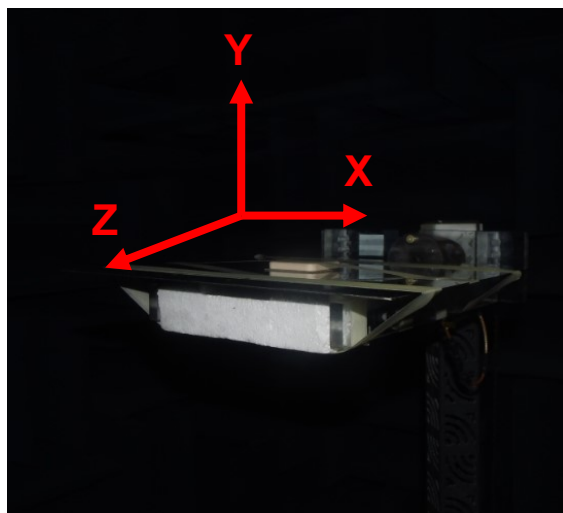

On 30*30cm ground plane

4.2 Antenna radiation patterns On 30*30cm Ground plane

XY Plane

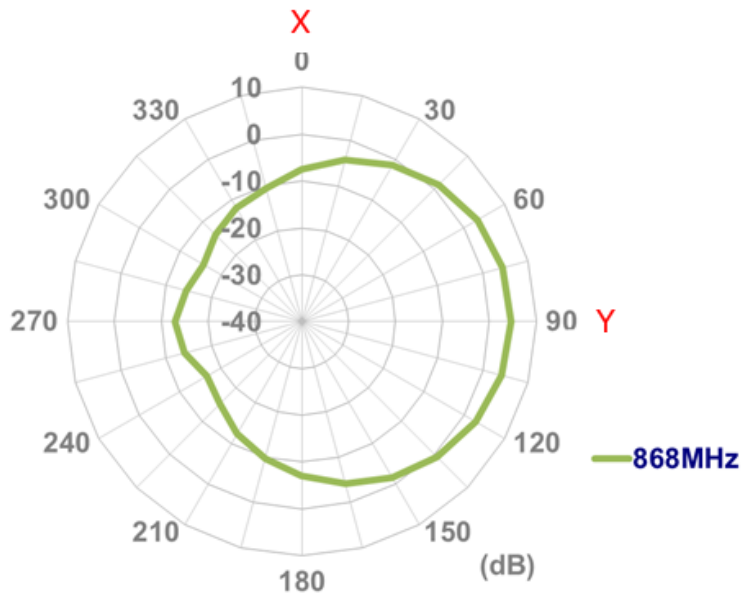

XZ Plane

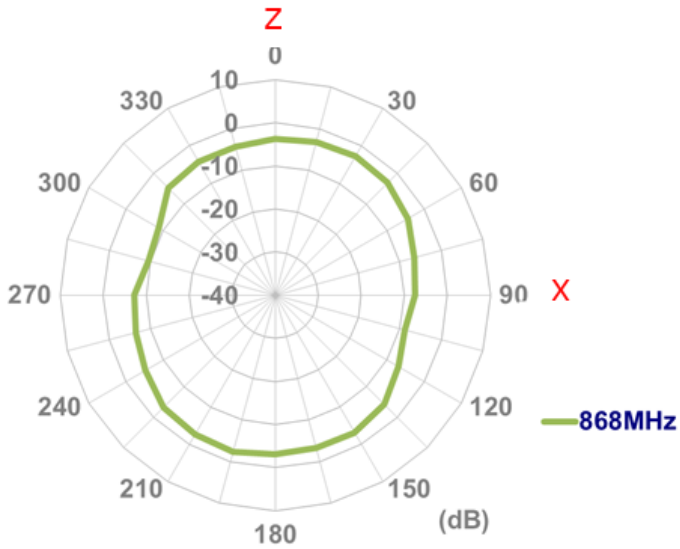

YZ Plane

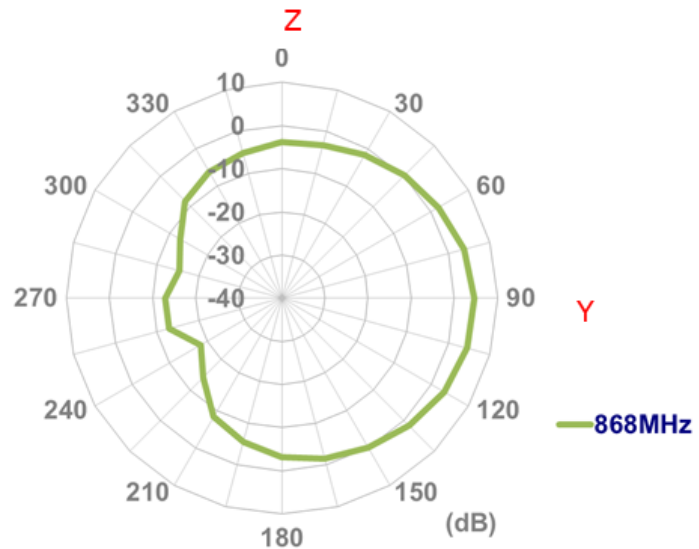

Free Space

XY Plane

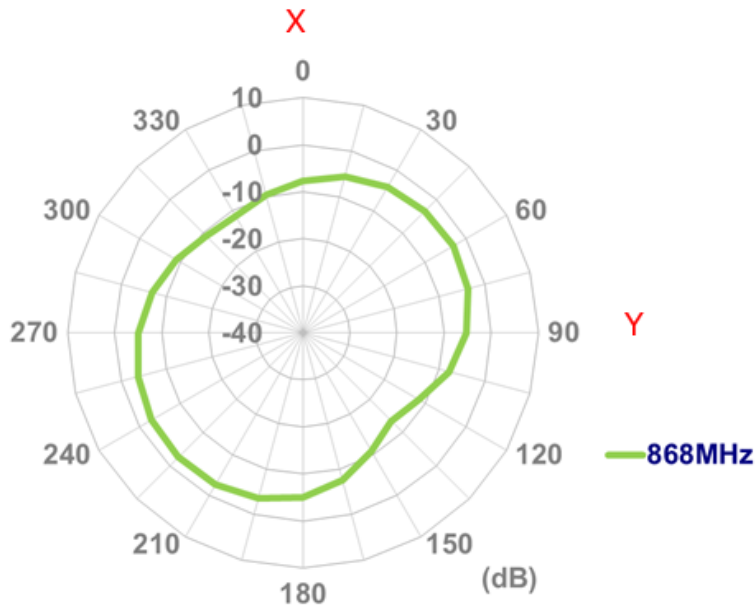

XZ Plane

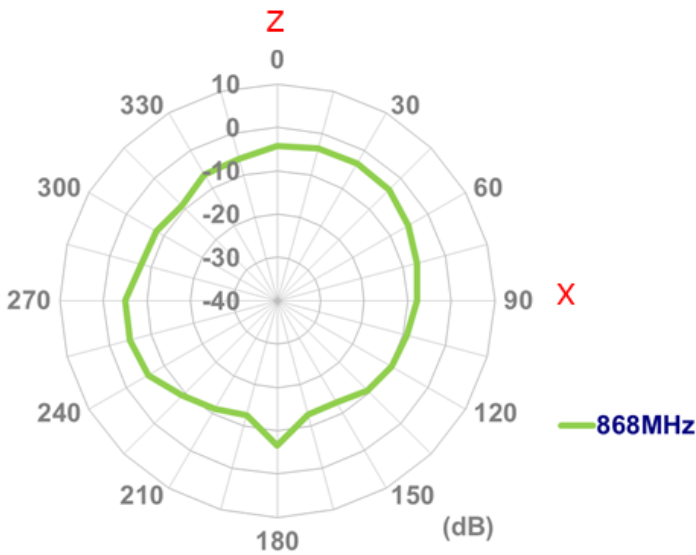

YZ Plane

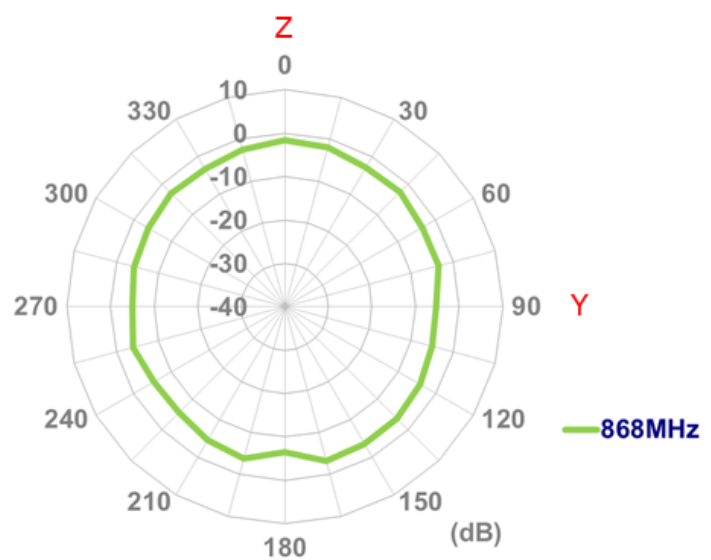

5. DRAWING

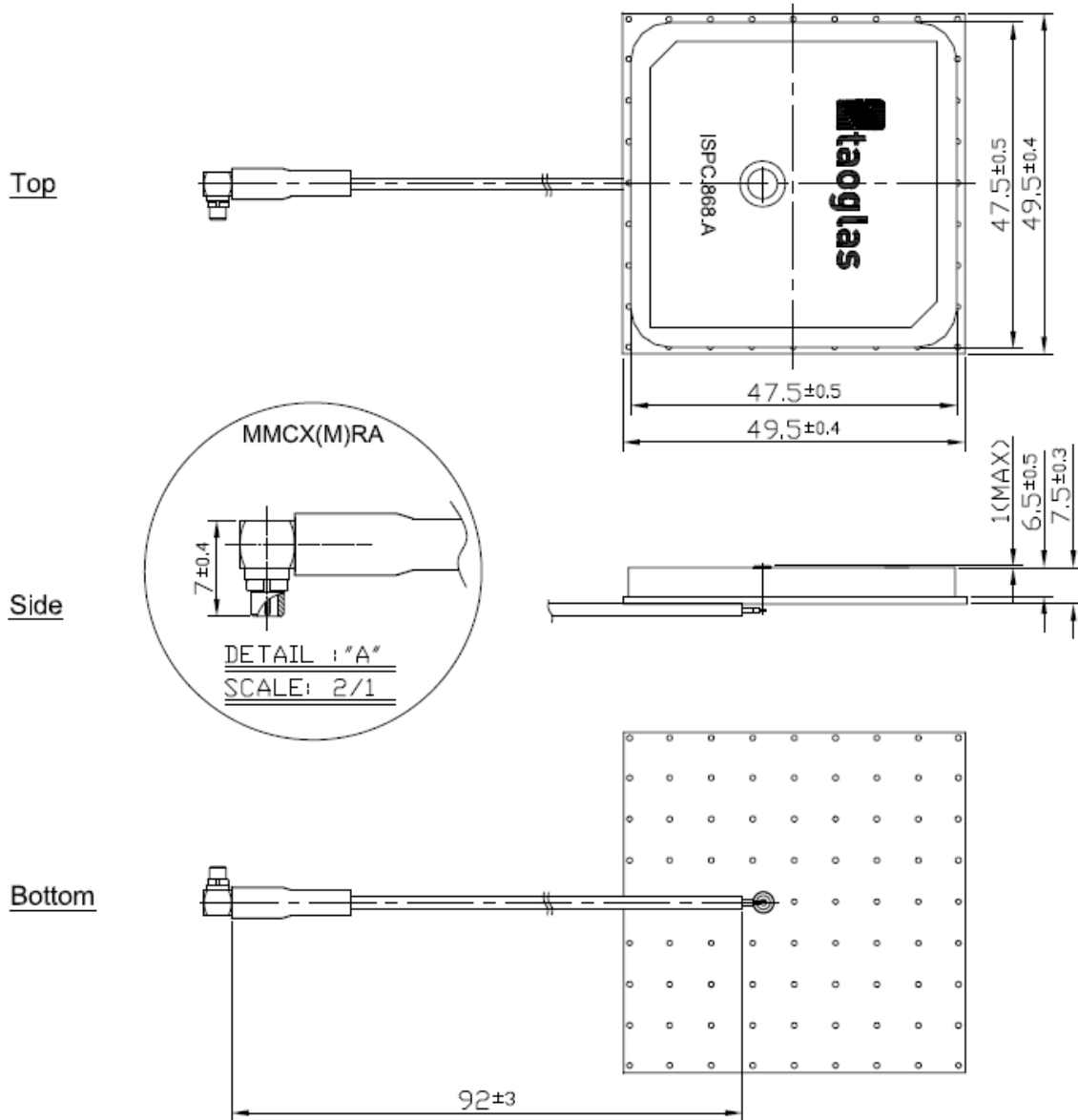

	Name	P/N	Material	Finish	QTY
1	868MHz Patch	001513H000007A	Ceramic	Clear	1
2	RG-178	301013A000007A	FEP	Brown	1
3	MMCX(M) RA	202713D010007A	Brass	Gold	1
4	PCB	100213H000007A	FR4 1t	N/A	1

6. APPLICATION NOTE

Taoglas considers the application here of the ISPC.86A antenna in different typical environments. Some environments the antenna will be close to ground plane (or general metal objects) and at different orientations. The distance to ground-plane will also differ. Following this rationale, we compiled the antenna S11 variation charts as below to evaluate the typical effects on performance. A degraded return loss would generally to relatively decreased efficiency, peak gain, and deformed radiation patterns. **Note - while it may appear from the return loss on the ground above antenna that the antenna may work in this orientation, it is likely the gain and efficiency are very poor, we would not recommend it under any circumstance**

There are three general situations of a ground plane orientation to antenna, the setup is as below.



Ground under antenna

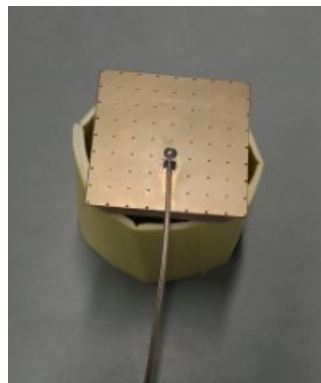

Ground above antenna

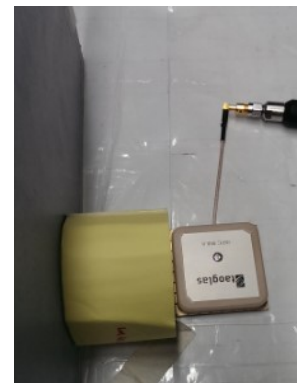

Ground side of antenna

Ground under antenna

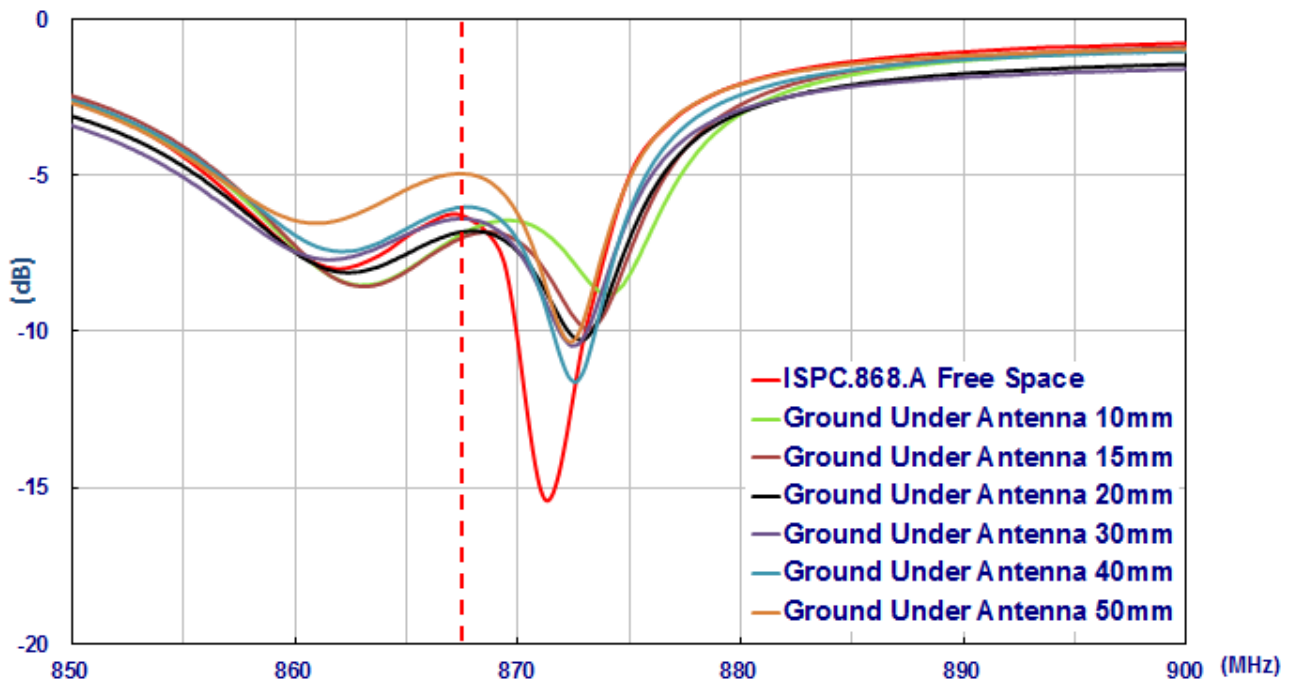
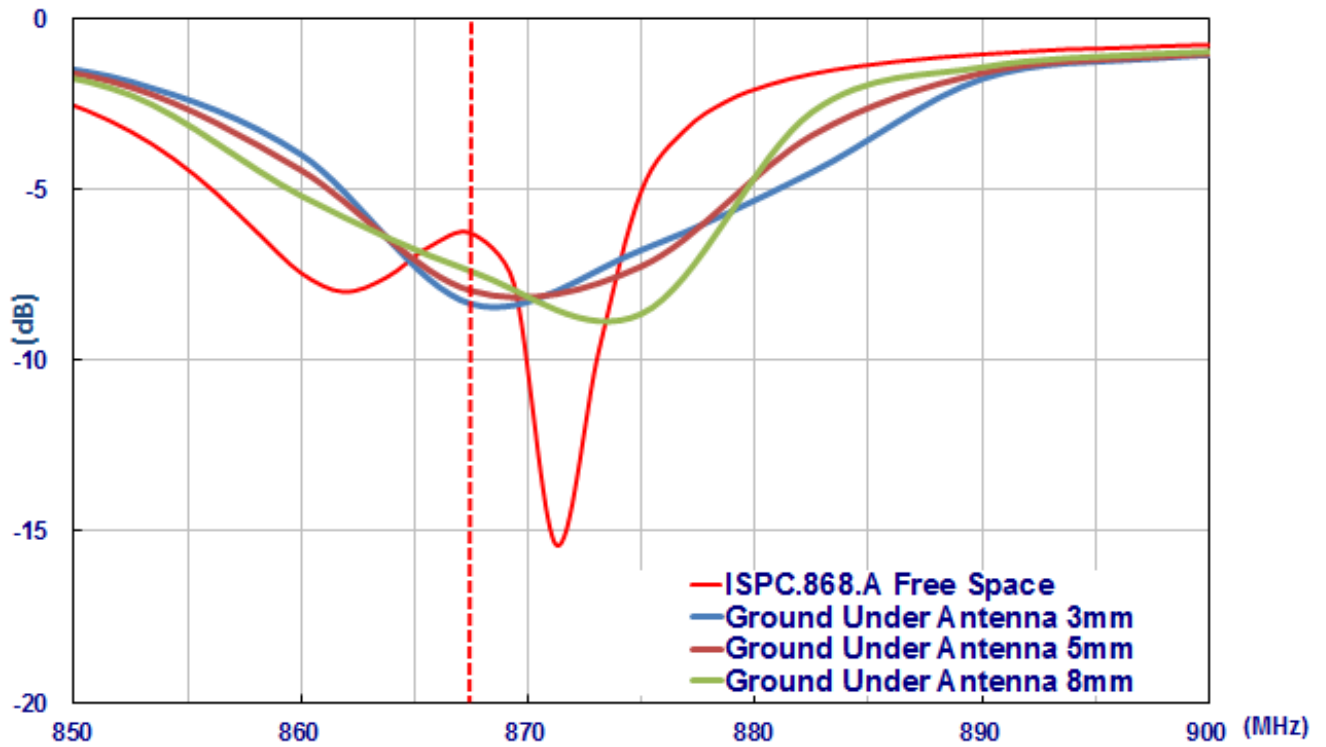

Ground above antenna

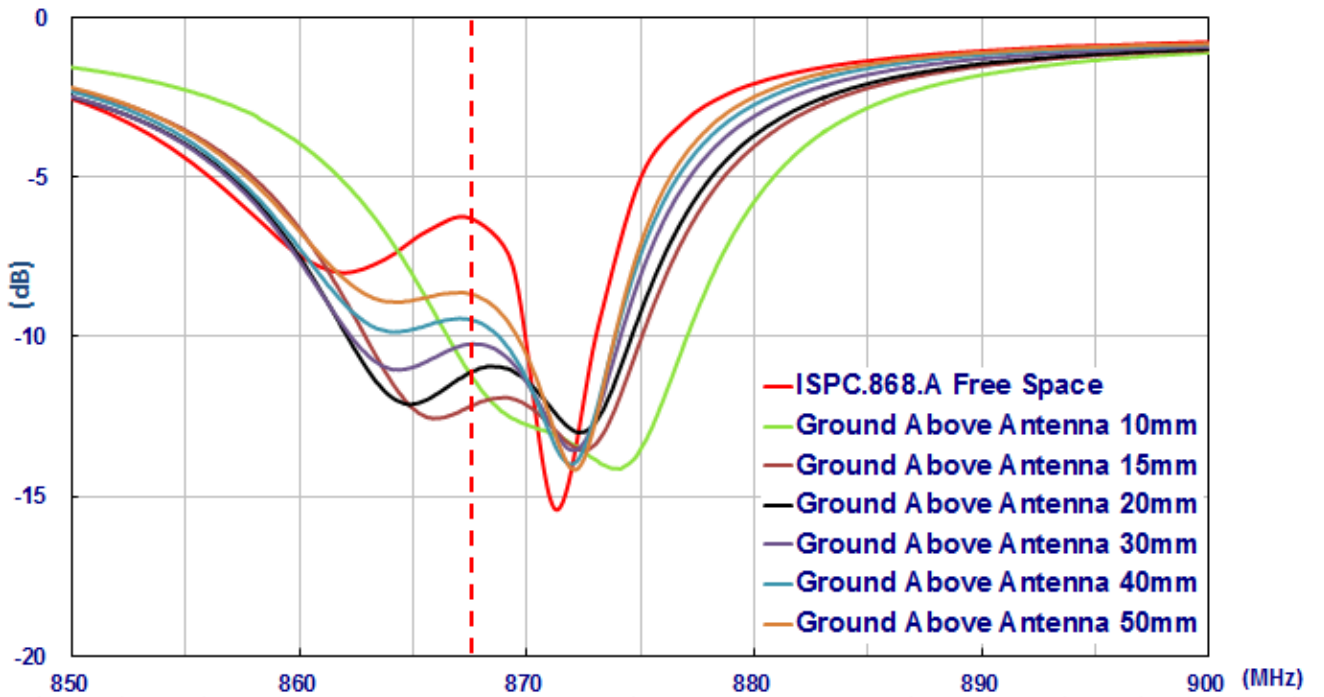
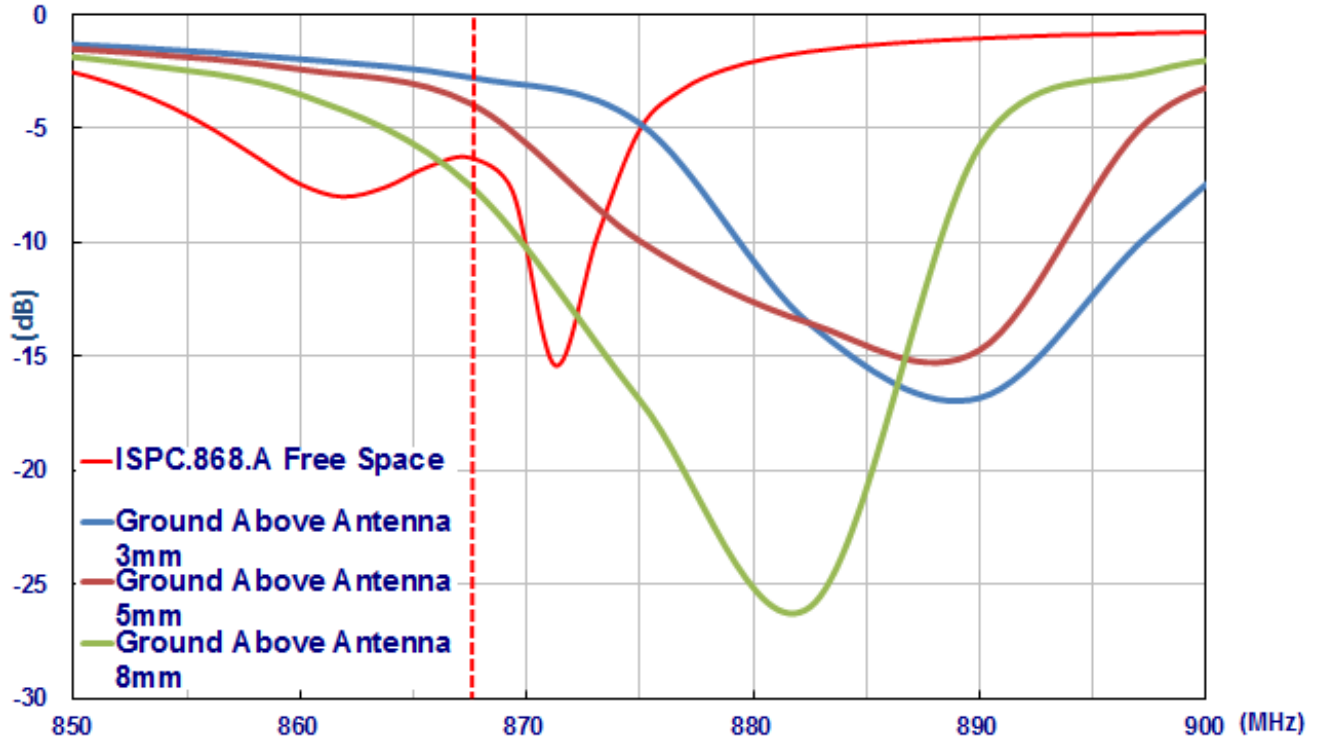

Ground side of antenna

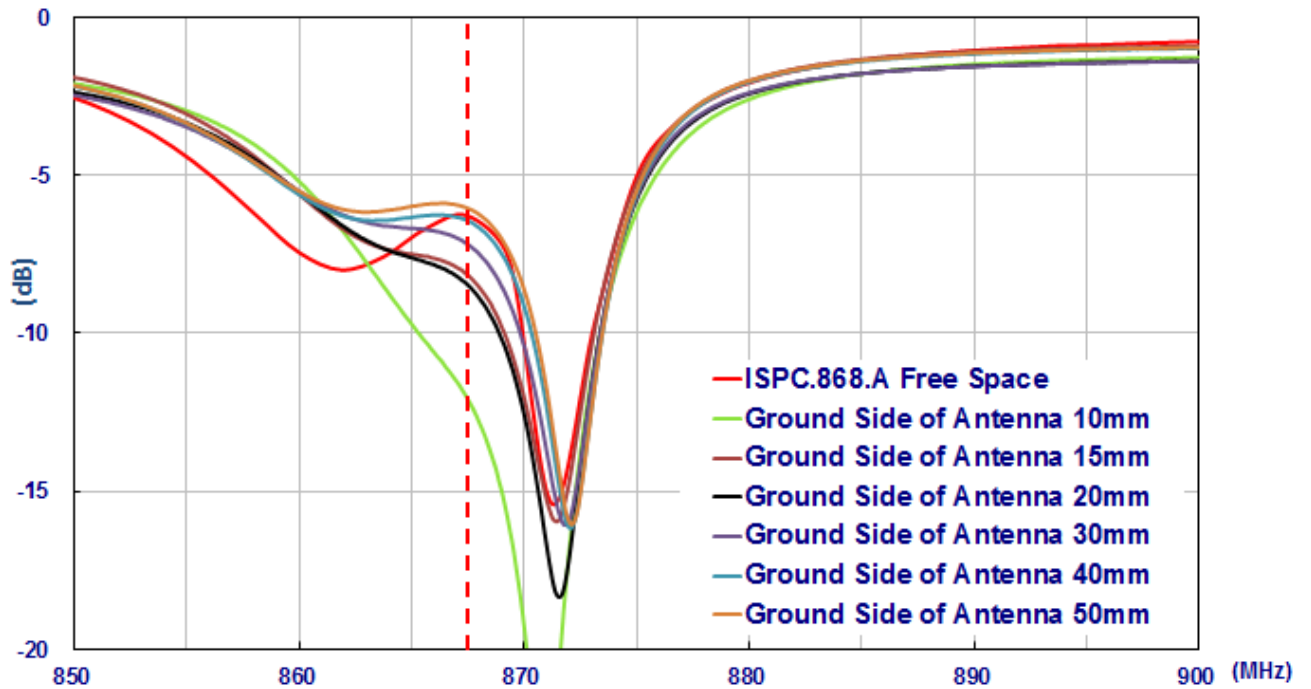
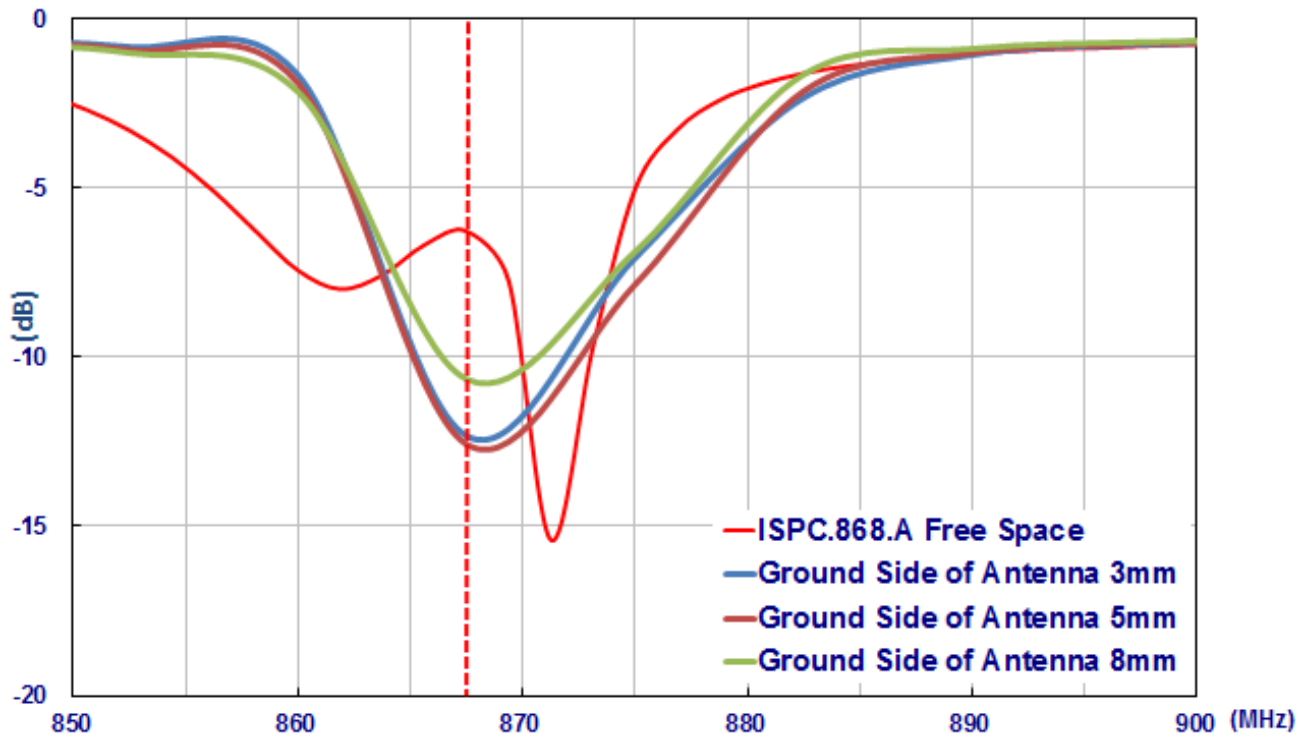

7. Packaging

8 pieces per Tray

5 Trays per Inside Box: 40 pieces

4 Inside Box's per Outer Box: 160 pieces

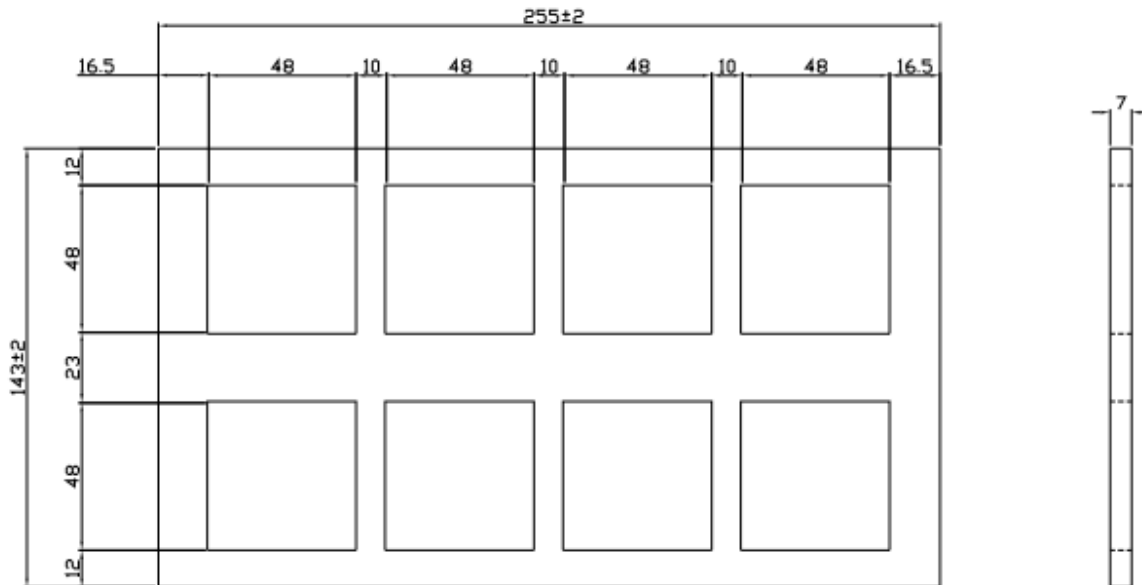

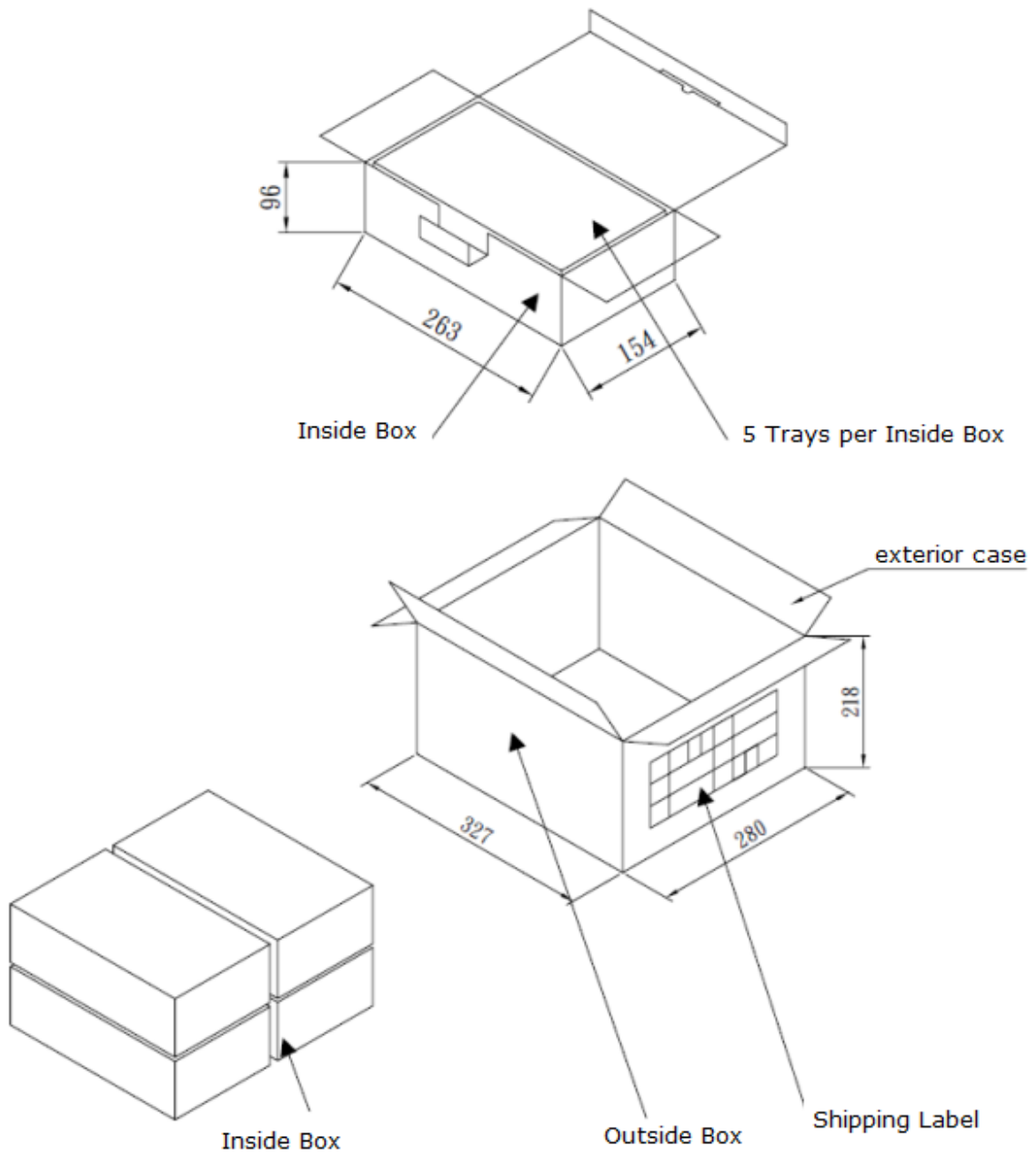

Taoglas makes no warranties based on the accuracy or completeness of the contents of this document and reserves the right to make changes to specifications and product descriptions at any time without notice. Taoglas reserves all rights to this document and the information contained herein.

Reproduction, use or disclosure to third parties without express permission is strictly prohibited.

Copyright © Taoglas Ltd.