

This application note describes the ISL6236 evaluation board intended for applications in notebook computers and other battery-powered devices.

Description

As notebook computer and battery-powered equipment complexity increases, higher levels of power management integration are required to meet market demands. To respond to the dynamic needs of its customers, Intersil introduces the quad outputs, multi-function power supply controller ISL6236. Its two fully programmable switch-mode power supplies (SPMS), one programmable and one fixed LDO outputs provide a robust power management solution for an extremely wide range of applications. In addition, it includes an optional 14V charge pump. For more information on the detailed workings of the ISL6236, please consult the ISL6236 Data Sheet on the Intersil Company website (<http://www.intersil.com>)

What's Inside

The Evaluation Board Kit contains the following materials:

- ISL6236 EVAL1 REV A Board
- ISL6236 Data Sheet
- ISL6236 Application Note (this document)

What's Needed

The following materials will be needed to perform testing:

- +25V, 20A Power Supply
- +5.0V, 750mA Power Supply
- Electronic Load up to 15A
- Precision digital multimeter
- 4-Channel oscilloscope

Note: amperage rating of power supplies are determined by maximum expected loading plus a percentage margin of error.

Quick Setup Guide

1. Set the +25V power supply to +7V and place in the “STANDBY” or “OFF” position. Connect the positive terminal (+) of the supply to the +VIN terminal P1 and the negative terminal (-) of the supply to GND P2.
2. Connect the positive terminal (+) of the electronic load to the VOUT1 terminal P5. Connect the negative terminal (-) of the electronic load to the GND terminal P6. Make sure the electronic load is set to the 0A condition.
3. Check to ensure all switches are in their default positions prior to application of power (refer to “Detailed Description of Switch Settings” on page 2).
4. Set all power supplies to the “ON” position. Check both 5V and 25V power supply outputs with a DMM to ensure correct voltage levels. Adjust if necessary.
5. Measure the default output voltages using DMM across the test points.
 - VOUT1: P7(+) to P8(-), it should read 5.0V
 - VOUT2: P5(+) to P6(-), It should read 3.3V
 - LDO: P3(+) to P4(-), It should read 5.0V
 - VREF3: P14(+) to P8(-), It should read 3.3V
 - CHARGE PUMP: P28(+) to P8(-), it should read 14.0V.

At this point, the board has been properly powered up. Normal testing can begin.

Summary

The ISL6236EVAL1 is an adaptable evaluation tool which showcases the performance of the ISL6236 chipset designed to meet the power management requirements of personal notebook computers or portable devices.

The following pages provide jumper settings, pinout, schematic of the board, bill of materials and layout drawings to support implementation of this solution.

The Intersil's total power management portfolio continues to expand with new selections to better fit our customer's needs. Refer to our web site for updated information: <http://www.intersil.com>

For technical assistance or other assistance please call 1-888-INTERSIL (468-3774).

How to Change Output Settings

Use following tables to change the adjustable outputs.

TABLE 1.

V _{OUT1}	FUNCTION
5V	FB1 = GND, Default
1.5V	FB1 = VCC
0.7V to 5.5V	V _{FB} *(1 + R11/R12) where V _{FB} = 0.7V

TABLE 2.

V _{OUT2}	FUNCTION
3.3V	REFIN2 = VCC, Default
1.05V	REFIN2 = VREF3
0.5V to 2.5V	VREFIN2, where VREFIN2 = 0.5 to 2.5V

TABLE 3.

LDO	FUNCTION
5V	LDOREFIN = GND, Default
3.3V	LDOREFIN = VCC
0.7V to 4.5V	2xVLDOREFIN, where VLDOREFIN = 0.35V to 2.25V

Detailed Description of Switch Settings

TABLE 4.

SW1	EN2	FUNCTION
1	GND	V _{OUT2} shut down
2	VCC*	V _{OUT2} Active
3	REF	V _{OUT2} sequence to Vout1

TABLE 5.

SW2	SKIP	FUNCTION
1	GND	Normal operational mode, automatic switch over to Pulse Skipping at light load
2	VCC*	Low Noise, fixed-frequency PWM
3	REF	Normal Operation Mode with Ultrasonic Pulse-skipping, 20kHz min.

TABLE 6.

SW3	EN_LDO	FUNCTION
1	GND	LDO shut down
2	VCC*	LDO Active
3	N/C	No Connect

TABLE 7.

SW4	BYP	FUNCTION
1	GND	Set BYP to 0V, No LDO switchover
2	VOUT1*	Bypasses LDO Voltage with V _{OUT1}
3	VOUT2	Bypasses LDO Voltage with V _{OUT2}

TABLE 8.

SW5	EN1	FUNCTION
1	GND	Vout1 Shutdown
2	VCC*	Vout1 Active
3	REF	Vout1 sequence to Vout2

NOTE: * Indicates default settings.

For all switches, only toggle one position at a time and use break-before-make sequencing to avoid shorting VCC to GND.

Pinout

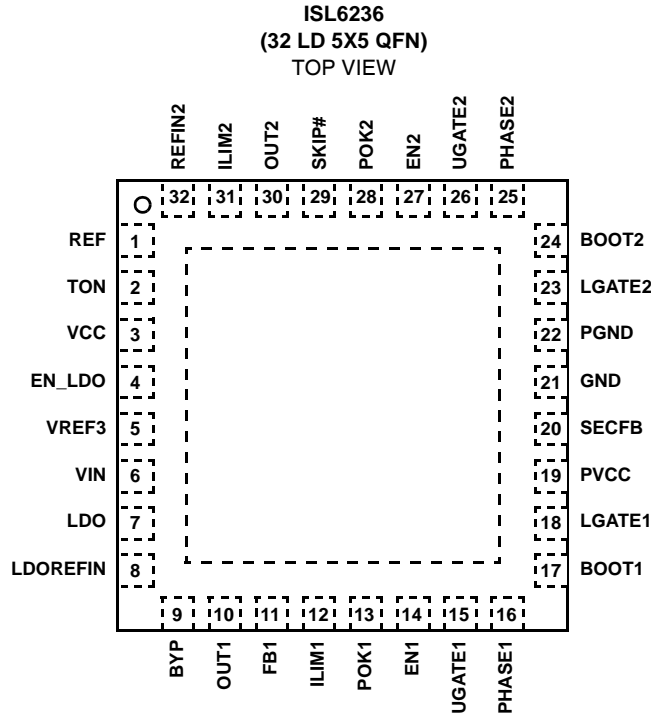

ISL6236 Evaluation Board Top and Bottom View

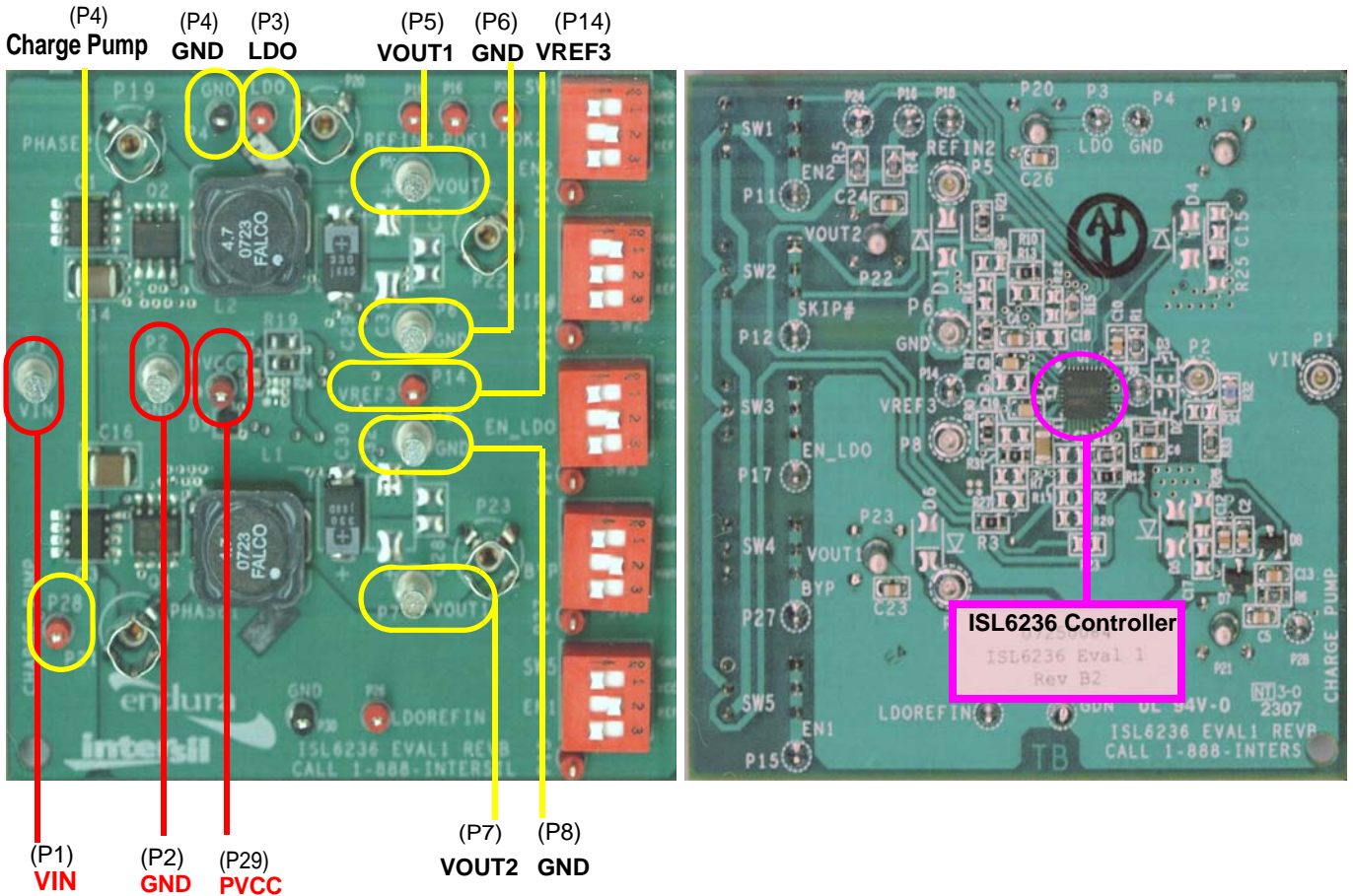

FIGURE 1. ISL6236EVAL1 REV B EVALUATION BOARD TOP AND BOTTOM VIEW

Application Note 1271

Components List:

REF DES	PART NUMBER	QTY	MANUFACTURER	DESCRIPTION
C1, C7, C8	08053D105KAT2A	3	AVX	1 μ F, 25V, X7R, 0805
C11	H1065-00475-10V10	1	GENERIC	4.7 μ F, 10V, X5R, 1206
C14, C16	TMK432BJ106KM	2	TAIYO-YUDEN	10 μ F, 25V, X5R, 1210
C2, C4, C5, C6, C10, C12, C13, C23, C24, C26	H1046-00104-50V10	10	GENERIC	0.1 μ F, 50V, X7R, 0805
C27, C28	OPEN	0	-	-
C29, C30	6TPD330M	2	POSCAP SANYO	330 μ F, 6.3V, POS CAP 9m Ω , D size
C3, C9, C15, C17, C18, C19	OPEN	0	-	-
C31, C32	OPEN	0	POSCAP	-
D1, D4-D6	OPEN	0	DIODES-INC	-
D2, D3	OPEN	0	ON-SEMI	-
D7, D8	BAT54sST	2	DIODES	0.2A, 30V, Schottky SOT23
D9	BAT54WT1-T	1	ON-SEMI	2A, 30V, Schottky SOT23
L1, L2	SD1003	2	FALCO	4.7 μ H, 7m Ω , 12.5x12.5mm Shielded
P1, P2, P5 to P8	1514-2	6	KEYSTONE	Test Point Turret 0.150 Pad 0.100 Thole
P19-P23	131-4353-00	5	TEKTRONIX	Scope Probe Test Point PCB Mount
P3, P11, P12, P14 to P18, P24, P26 to P29	5000	13	KEYSTONE	Miniature Red Test Point 0.100 Pad 0.040 Thole
P4, P30	5001	2	KEYSTONE	Miniature Black Test Point 0.100 Pad 0.040 Thole
Q1	IRF7821	1	IR	30V, 13.6A HEXFET Power MOSFET
Q2	IRF7832	1	IR	30V, 20A HEXFET Power MOSFET
Q3	IRF7807V	1	IR	30V, 8.3A N-Channel Power MOSFET
Q4	IRF7811AV	1	IR	30V, 10.8A N-Channel Power MOSFET
R1, R8	H2512-00010-1/8W	2	GENERIC	1 Ω , 1%, 0805
R15	H2512-01503-1/10W1	1	GENERIC	150k Ω , 1%, 0805
R2, R7, R9, R11, R13, R14, R18, R19, R20, R22, R23, R27, R34	OPEN	0	-	-
R25, R26	OPEN	0	-	-
R3, R10, R12, R17, R21, R24, R30, R31	H2512-00R00-1/10W	8	GENERIC	0 Ω , 1%, 0805
R32	H2512-03922-1/10W1	1	GENERIC	39.2k Ω , 1%, 0805
R4, R5, R16, R33	H2512-02003-1/10W1	4	GENERIC	200k Ω , 1%, 0805
R6	H2512-025R5-1/8W1	1	GENERIC	25.5 Ω , 1%, 0805
SW1 to SW5	78B03S	5	GRAYHILL	Dip Switch SPST (Raised Slide)
U1	ISL6236IRZA	1	INTERSIL	High-Efficiency, Quad Output Controller

Layout

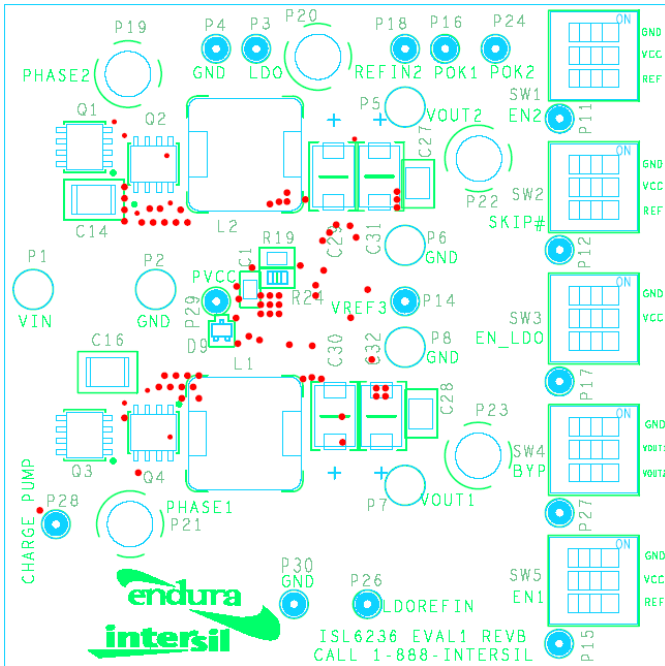

FIGURE 3. TOP COMPONENTS

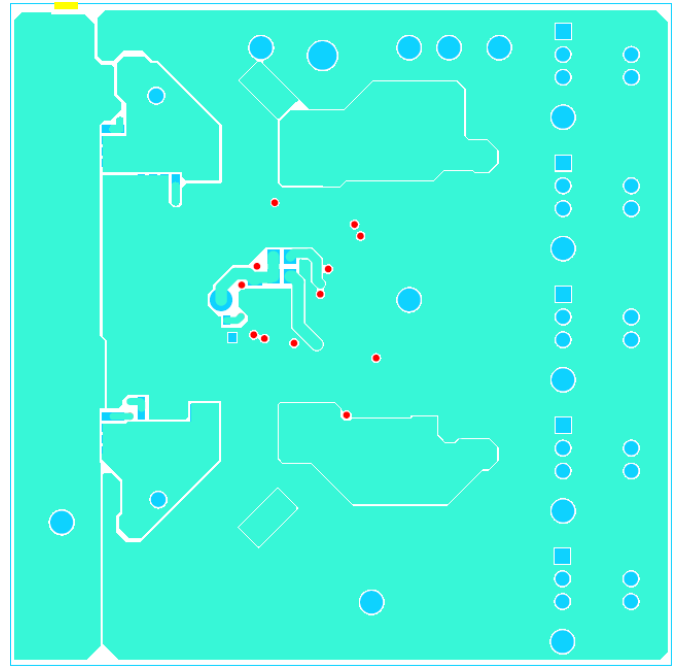

FIGURE 4. TOP ETCH

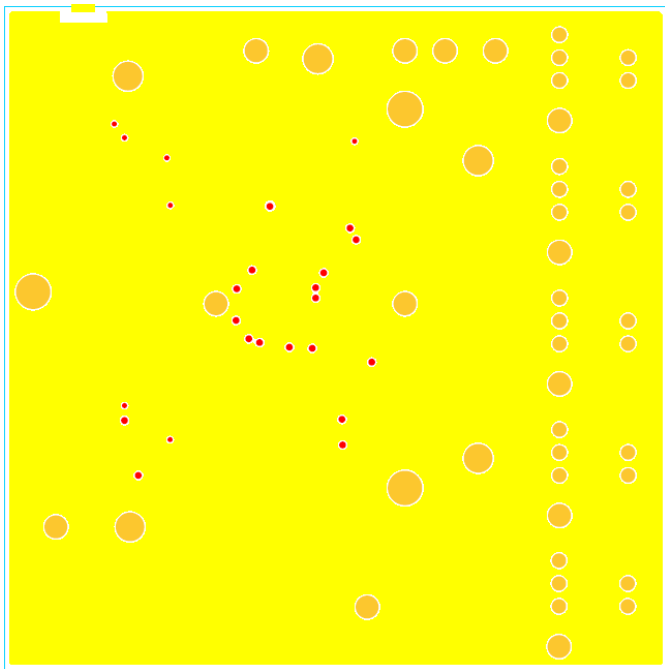

FIGURE 5. 2nd LAYER

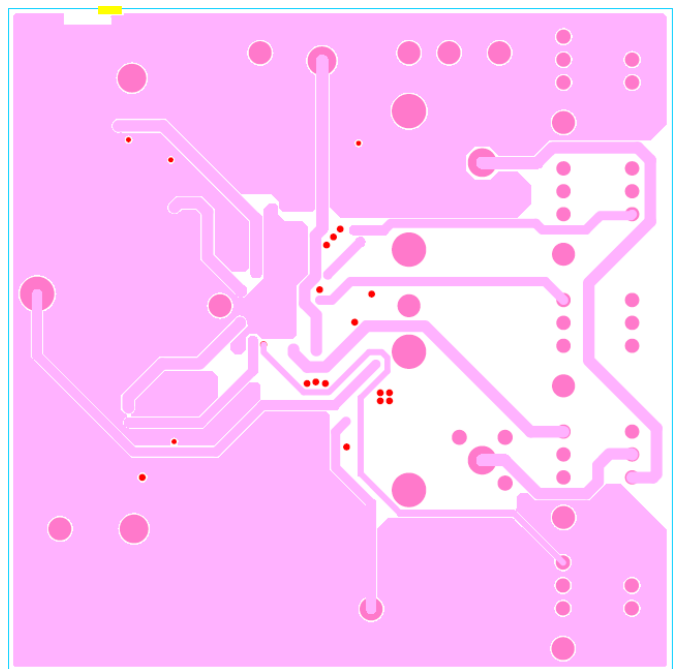

FIGURE 6. 3rd LAYER

Layout (Continued)

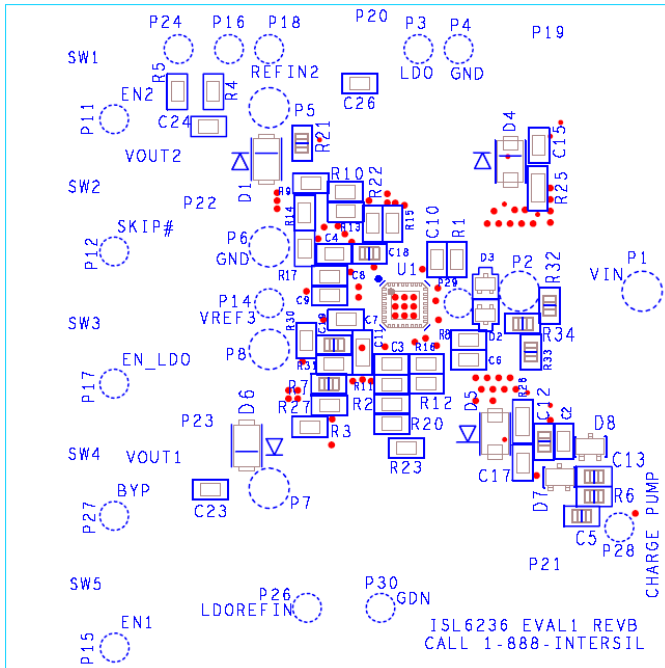

FIGURE 7. BOTTOM COMPONENTS (MIRRORED)

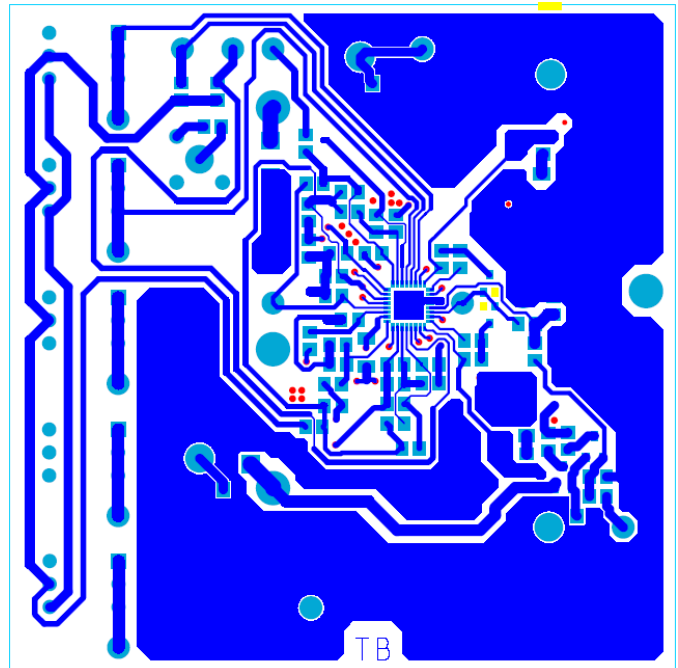

FIGURE 8. BOTTOM ETCH (MIRRORED)

Intersil Corporation reserves the right to make changes in circuit design, software and/or specifications at any time without notice. Accordingly, the reader is cautioned to verify that the Application Note or Technical Brief is current before proceeding.

For information regarding Intersil Corporation and its products, see www.intersil.com