

## FEATURES

- Fully Assembled and Tested PCB
- Allows Simple Evaluation of the ACT8865
- Probe Points for Easy Measurement

## GENERAL DESCRIPTION

The ACT8865EV contains a fully assembled and tested circuit board designed to demonstrate all the features of the ACT8865. The ACT8865EV includes a variety of test points and jumpers as necessary to configure and evaluate the ACT8865's functionality.

## QUICK START GUIDE

### *Recommended Equipment*

- 1) Variable Power Supply
- 2) DMM
- 3) Load Resistors or Electronic Load
- 4) *ActivePMU*<sup>™</sup> Dongle and Cable
- 5) ACT8865EV GUI software

### *Quick Start Operating Procedure*

The following procedure should be used when operating the ACT8865EV for the first time to verify correct operation.

- 1) Do not turn the power supply ON until all connections have been made.
- 2) Connect the power supply positive lead to the VIN pin connector.
- 3) Connect the power supply negative lead to the GND pin connector located near the VIN pin connector.
- 4) Connect INL45, INL67 to VIN by connecting J1, J2 Jumper.
- 5) Connect the corresponding pin of J6 Jumper to dongle through cable.
- 6) Connect dongle to the computer which has the ACT8865 GUI Software installed. Make sure all the Jumpers: J5\_1; J5\_2; J5\_3; J5\_8 are shipped to the right (GND).
- 7) Set the power supply to 5V.
- 8) Turn on the power supply.
- 9) Ship the middle J5\_8 Jumper (IO8\_PWRHLD) to left (VIN) to enable the REG1, REG2 and REG3. Or ship it to right side (GND) to disable REG1, REG2 and REG3.
- 10) Evaluate the REG1, REG2 and REG3 using

DMMs or scope.

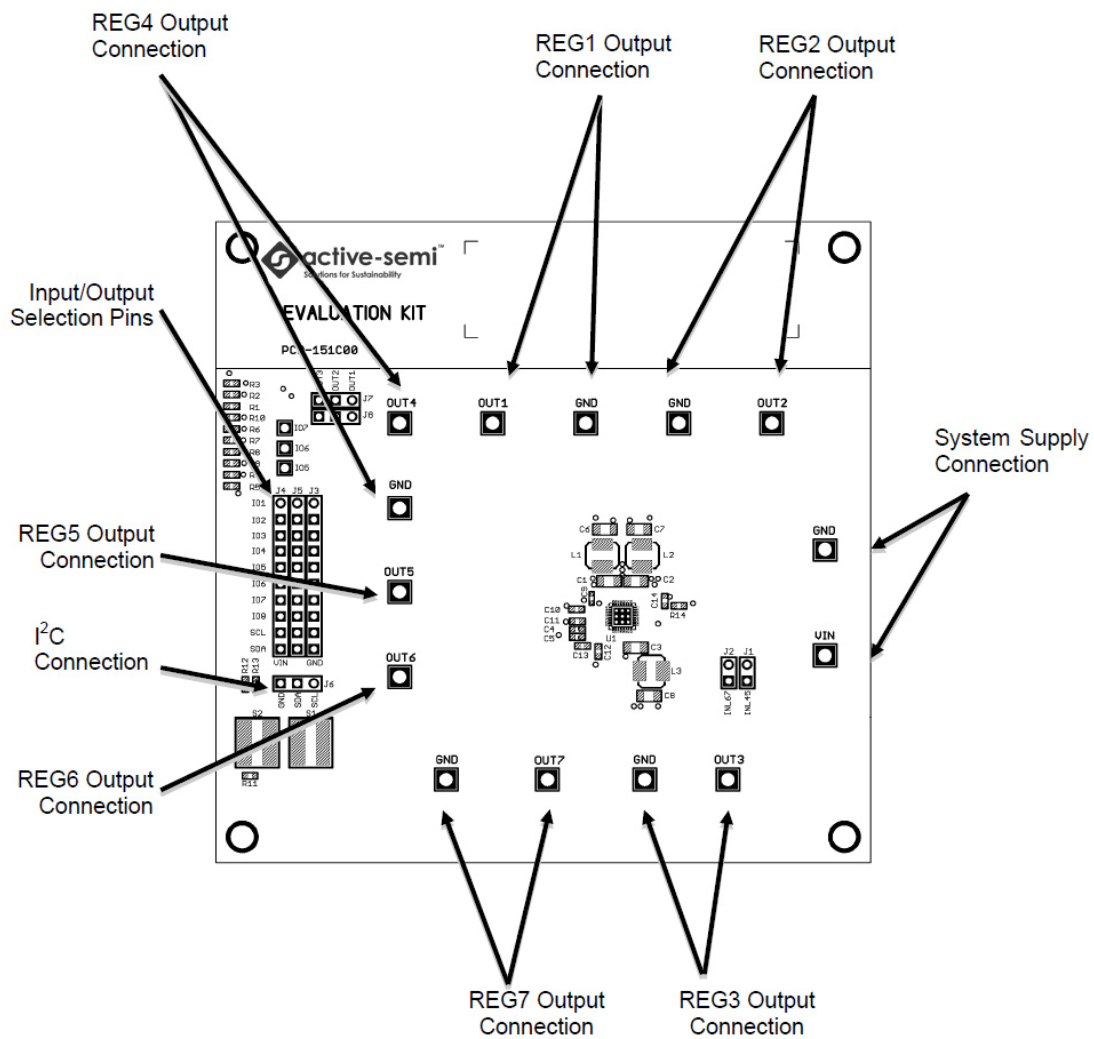
- 11) Ship the middle J5\_3 Jumper (IO3\_PWREN) to left (VIN) to enable the REG4, REG5, REG6 and REG7. Or ship it to right side (GND) to disable REG4, REG5, REG6 and REG7.
- 12) Evaluate the REG4, REG5, REG6 and REG7 using DMMs or scope.

To evaluate the advanced features of REG1 to REG7, click the Advanced Mode button and select the REG tabs to allow direct access to the control bits. Refer to the ACT8865 data sheet for more information regarding the REG1 to REG7 control registers.

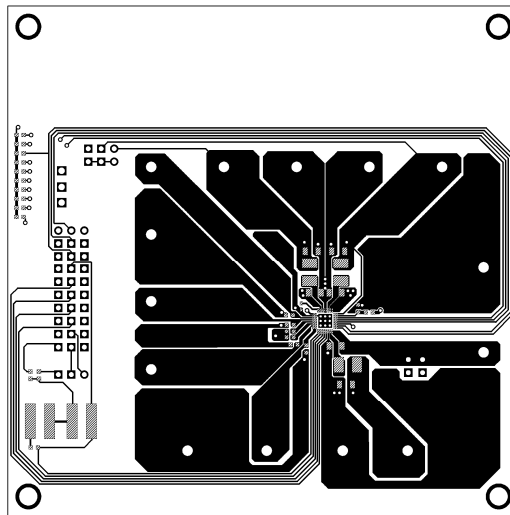
## ACT8865 Evaluation Kit

### PCB LAYOUT

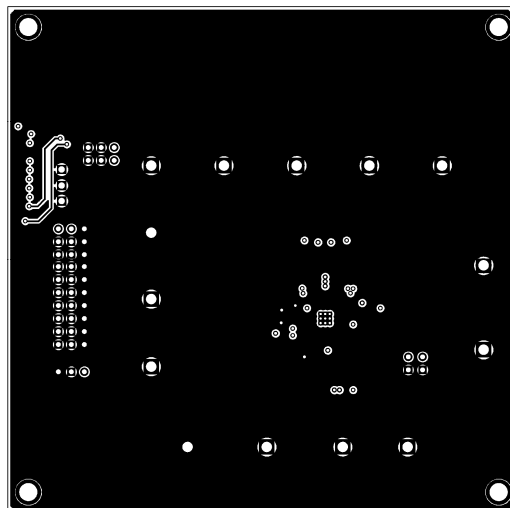
**Figure 1:**  
**Component Placement – Top Layer**



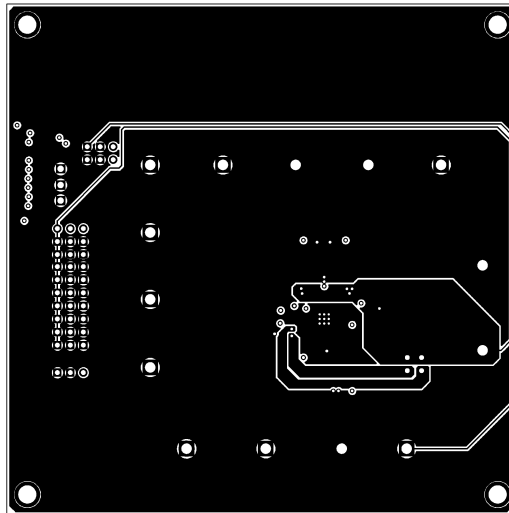
**Figure 2:**  
PCB Layout – Top Layer



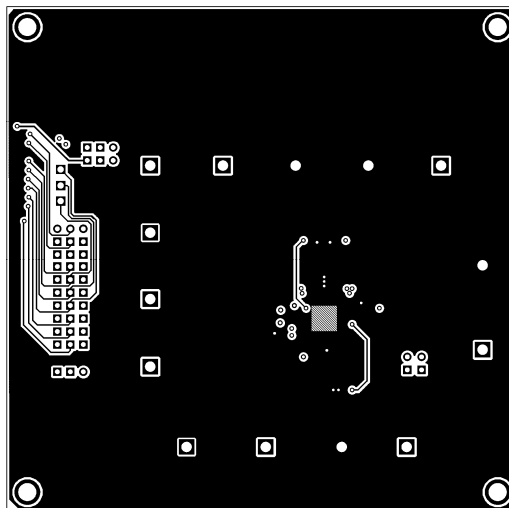
**Figure 3:**  
PCB Layout – Mid 1 Layer



**Figure 4:**  
PCB Layout – Mid 2 Layer

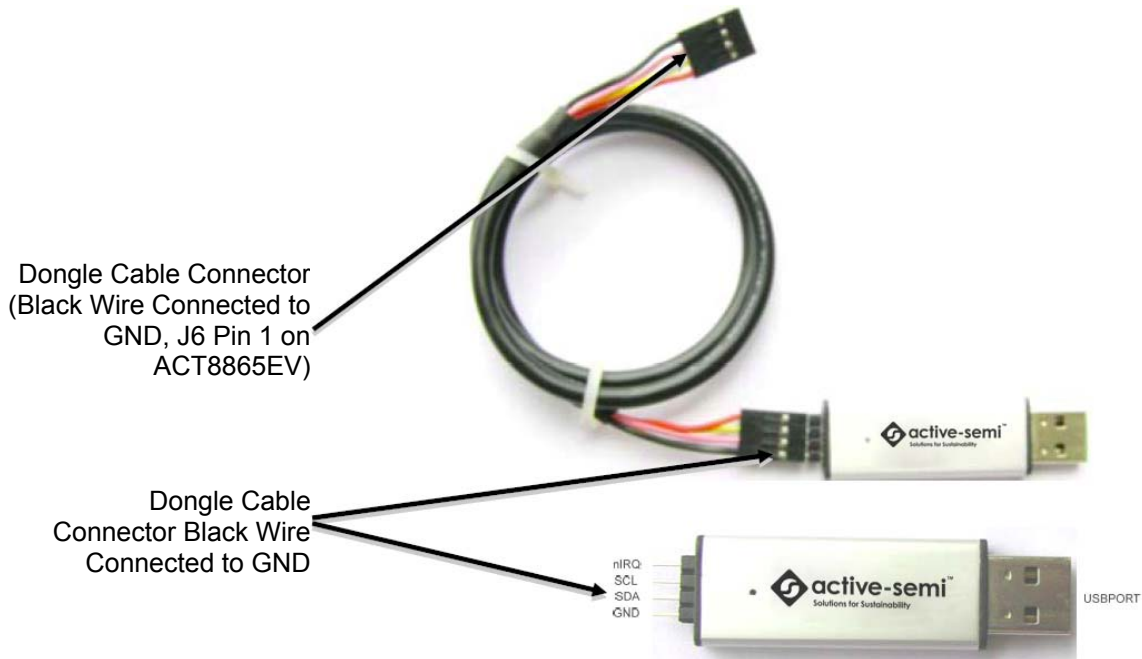


**Figure 5:**  
PCB Layout – Bottom Layer



**Figure 6:**

**ACT8865EV Evaluation Kit Programming Dongle. The Black Wire Ground Pin on the Cable Connects to the Dongle as Shown.**



### ACT8865EV USB-to-I<sup>2</sup>C Programming Dongle

The ACT8865EV USB-to-I<sup>2</sup>C Programming Dongle connects to the ACT8865EV board through a 4 wire cable with a 4 pin connector at each end. The black wire is ground and should be oriented as shown in Figure 6. As a guide, use the “Active-Semi” logo on the top of the programmer so that the black wire is connected toward the lower left corner of the Dongle.

On the ACT8865EV PCB board, the black wire is connected to pin 1 of J6 shown in Figure 6. See the section, *Quick Start Operating Procedure* to verify the ACT8865EV operation using the Dongle and the GUI.

Figure 7:

ACT8865EV Evaluation Kit Schematic

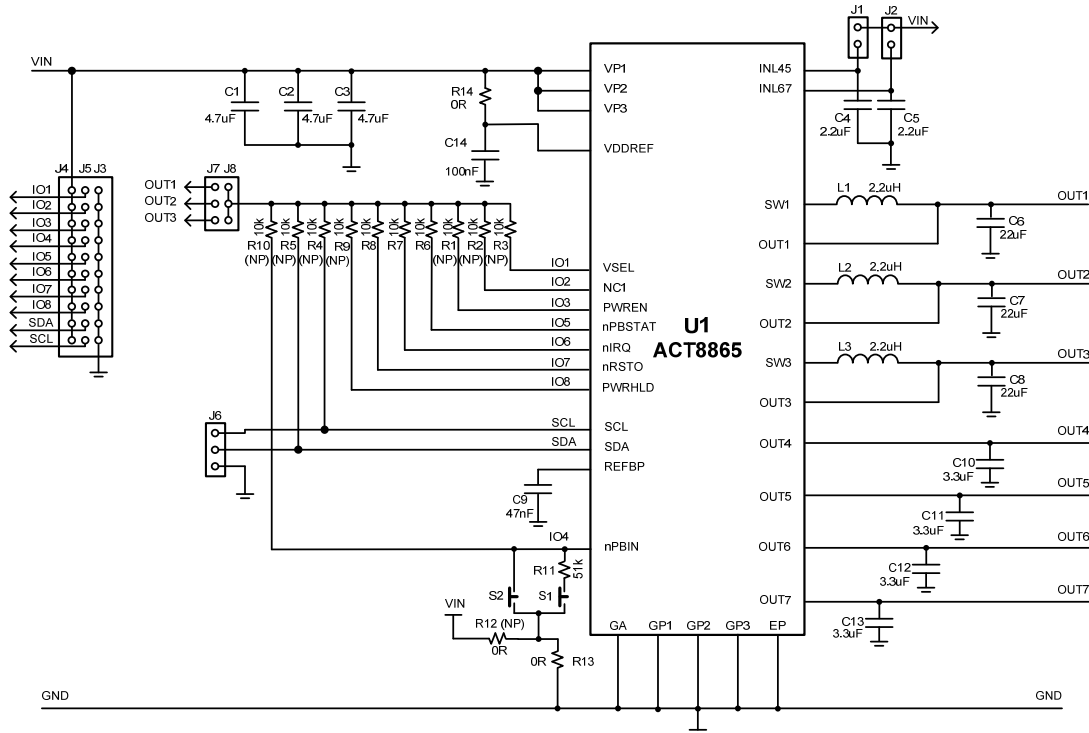


Table 1:

Pins/Connectors Description

NAME	JUMPER	DESCRIPTION
VIN	Connector	Power Input Pin Connector. Power input for the ACT8865EV board.
GND	Connector	Ground Pin Connector.
J1	Connector	Power Input Pin Connector for OUT4 and OUT5.
J2	Connector	Power Input Pin Connector for OUT6 and OUT7.
J3, J4, J5	Connector	Pull up Voltage Connector.
J6	Connector	Dongle Cable Connector.
J7, J8	Connector	Using jumper connecting OUTx to OUT1, OUT2 or OUT3 to select which output is used to pull the resistors up.
VSEL	IO1	Step-Down DC/DCs Output Voltage Selection Input. Default setting VSEL is connected to GND. Please see in the datasheet for more details.
NC1	IO2	Not Connected. Not internally connected.
PWREN	IO3	Power Enable Input. Please see in the datasheet for more details.
nPBIN	IO4	Master Enable Input. Please see in the datasheet for more details.
nPBSTAT	IO5	nPBIN State Indicator.
nIRQ	IO6	Open Drain Interrupt Output.
nRSTO	IO7	Signal Reset Timeout Output Pin.
PWRHLD	IO8	Power Hold Input. Please see in the datasheet for more details.

## ACT8865 Evaluation Kit

**Table 2:**
**ACT8865EV Bill of Materials**

ITEM	DESCRIPTION	MANUFACTURER	QTY	REFERENCE
1	IC, PMU, ACT8865	Active-Semi	1	U1
2	Resistor, 10kΩ, 5%, SMT, 0603	FengHua, Neohm, Yageo	10	R1 (NP), R2 (NP), R3 (NP), R4 (NP), R5 (NP), R6, R7, R8, R9 (NP), R10 (NP)
3	Resistor, 51kΩ, 5%, SMT, 0603	FengHua, Neohm, Yageo	1	R11
4	Resistor, 0Ω, 5%, SMT, 0603	FengHua, Neohm, Yageo	3	R12 (NP), R13, R14
5	Capacitor, Ceramic, 4.7μF / 10V, X7R, SMT, 0805	Panasonic, Kemet, Murata, TDK, FengHua, Taiyo Yuden	3	C1, C2, C3
6	Capacitor, Ceramic, 22μF / 10V, X7R, SMT, 0805	Panasonic, Kemet, Murata, TDK, FengHua, Taiyo Yuden	3	C6, C7, C8
7	Capacitor, Ceramic, 2.2μF / 6.3V, X7R, SMT, 0603	Panasonic, Kemet, Murata, TDK, FengHua, Taiyo Yuden	2	C4, C5
8	Capacitor, Ceramic, 3.3μF / 6.3V, X7R, SMT, 0603	Panasonic, Kemet, Murata, TDK, FengHua, Taiyo Yuden	4	C10, C11, C12, C13
9	Capacitor, Ceramic, 100nF / 6.3V, X7R, SMT, 0603	Panasonic, Kemet, Murata, TDK, FengHua, Taiyo Yuden	1	C14
10	Capacitor, Ceramic, 47nF / 6.3V, X7R, SMT, 0402	Panasonic, Kemet, Murata, TDK, FengHua, Taiyo Yuden	1	C9
11	Inductor, CDRH3D16HP-3R3NC, 3.3μH, SMT	Sumida	3	L1, L2, L3
12	PIN	Molex, Hirose	14	VIN, GND (6), OUT1, OUT2, OUT3, OUT4, OUT5, OUT6, OUT7
13	PIN (HOLD 1.2mm), 1PIN	Molex, Hirose	3	nRSTO, nIRQ, nPBSTAT
14	2.54mm, 2PIN	Molex, Hirose	2	J1, J2
15	2.54mm, 10PIN	Molex, Hirose	3	J3, J4, J5
16	2.54mm, 3PIN	Molex, Hirose	3	J6, J7, J8
17	Push-Button Switch	Nikkai Omron	2	S1, S2

(NP): Not Populated

## INTRODUCTION

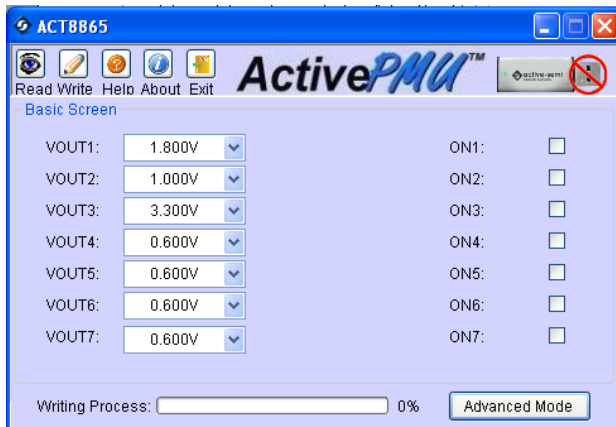
The *ActivePMU™* evaluation system facilitates a complete solution to evaluate Active-Semi's advanced family of PMU products (ACT5xxx, ACT8xxx). The evaluation kit requires a software protection dongle to be used (provided in evaluation kit).

## USER INTERFACE

Clicking on the *ActivePMU.exe* Icon invokes the *ActivePMU™* evaluation system main window as shown in Figure 8 below.

*Note: The user interface for ACT8865 is used for illustration only.*

**Figure 8:**  
**User Interface**



Each product or product family has a unique main window layout providing the user programmable features.

- The product/product family is shown at the top left of the main window.
- The tool bar in the top right of the main window provides access to the main operation features:
  - Read/Write: Read/Write configuration from PMU
  - Help, About and Exit
- Dongle Connection Status
- The user programmable configuration options are programmed using the drop down boxes (e.g. VOUT1, VOUT2 etc...)
- Writing process bar: indicates the progress of the PMU configuration writing process.
- Advance/Basic mode selection button enables the user to toggle the user interface between Basic and

advanced configuration modes.

## GETTING STARTED

### 1. Software Protection Dongle

In order to operate the *ActivePMU™* evaluation system, the software protection dongle must be connected at all times. The dongle is connected to the USB port of the PC. Figure 9 below shows the two possible indication status graphics.

**Figure 9:**

**Dongle Connected**



**Dongle Disconnected**

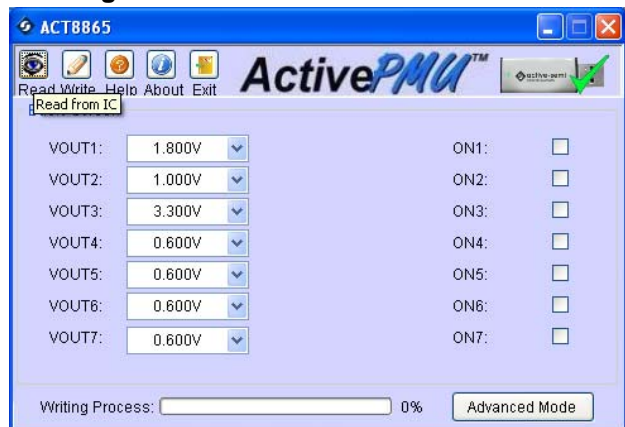


### 2. Reading the PMU Configuration

The current configuration settings of the PMU can be read by clicking the "Read" button on the tool bar.

*Note: The progress of the configuration reading is shown in the Progress bar (See figure 10)*

**Figure 10:**  
**Reading from IC**



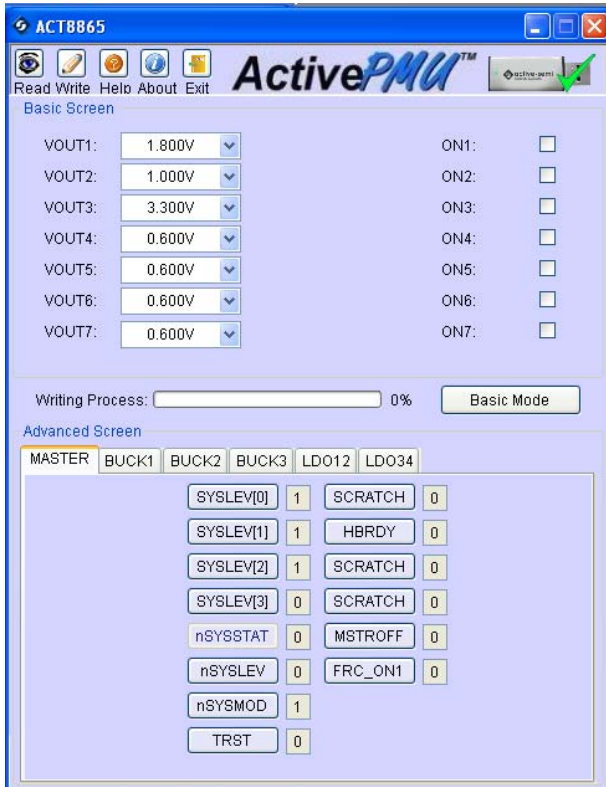
After reading from IC, output value will be appear in form. With Basic Mode selected, only the output settings are shown.

Click on the Combo boxes or checkboxes to set the value for outputs.

Click the "Advanced Mode" button to see all available user programmable options. With Advanced Mode, additional user programmable features can be selected using the radio buttons, combo boxes.



**Figure 11:**  
**Advanced Mode Screen**



### 3. Writing the Configuration to the PMU

To write the configuration selected to the PMU, click the “Write” button in main window.

*Note: The “Read/Write Progress bar” indicates the status of the writing operation.*

**Figure 12:**  
**Writing to IC**



The Advanced/Basic configuration modes are available for both reading and writing the PMU.

### 4. Help

Addition information and hints can be found by clicking the “Help” button in the toolbar.

### 5. Exit

To exit this software, click on the “Exit” button in the toolbar.