



life.augmented

ST's solutions for mobile devices





Content

Introduction	4
MEMS and Sensors.....	5
Imaging solutions.....	12
Audio solutions.....	15
Mobile security solutions.....	17
NFC tags	19
Serial EEPROM.....	21
Signal conditioning	23
Microcontrollers.....	24
Radio frequency	32
Smart antenna tuning.....	34
Interfaces.....	37
Protection and EMI filtering	40
Power management.....	44





Introduction

STMicroelectronics is a leading semiconductor supplier in the mobile industry and provides solutions to both mobile platform suppliers and mobile device manufacturers (OEM/ODM). ST has proven products for the cellular handset and mobile device markets and ships billions of products to the mobile industry every year.

These products include the world's most deployed MEMS accelerometers, gyroscopes, magnetometers, pressure sensors, compasses and inertial modules, state-of-the-art analog and digital MEMS microphones, high-quality audio headphone and speaker amplifiers, touch-sensor controllers with multi-touch capabilities, Near Field Communication Secure MCUs for SIM, M2M SIM and Secure Elements, a wide RF product offer based on Integrated passive device technology, ESD protection and EMI filtering products (IPAD™), interface devices, level translators, I/O expanders, antenna tuner, analog switches, supervisors and smart resets, imaging solutions with photonic sensors like proximity and gesture sensors, ranging sensors, ambient light sensors, high-efficiency power management devices and innovative lighting management solutions. ST is an active player in all major standardization initiatives.

- High-volume manufacturing capacity
- Multiple production sites
- Integrated HW and SW solutions
- High-quality products, already tested in different application fields
- Strong commitment to Sustainable Technology

4

IMAGING SOLUTIONS

Proximity and gesture sensors, ranging sensors, and ambient light sensors

MEMORY

Serial EEPROM
(2 Kbits up to 2 Mbits) in a miniature packages

SENSORS AND USER INTERFACES

Accelerometers, gyroscopes, pressure sensors, iNEMO-Inertial modules, digital compasses, proximity sensors, touchscreen controllers, optical finger navigation sensors, and temperature sensors

RADIO FREQUENCY

Couplers, diplexers, baluns, and band-pass filters

PROTECTION AND EMI FILTERING

ESD and EOS protections, EMI filtering

SIGNAL CONDITIONING

Op amps, comparators

INTERFACE AND INTERCONNECTED DEVICES

Level translators, I/O expanders, camera interfaces, analog switches, supervisors and smart resets

MICROCONTROLLERS

32-bit STM32 ARM® Cortex® -based MCUs and 8-bit STM8 MCUs offer a wide choice of solutions

NFC, SIM AND SECURE ELEMENTS

NFC controllers and transceivers, and secure MCUs

AUDIO SOLUTIONS

MEMS digital and analog microphones, headphone and speaker amplifiers

POWER MANAGEMENT

LDO and DC-DC converters, battery management, Flash LED and backlight drivers, and OLED display power supplies, battery monitoring

SMART ANTENNA TUNING

Tunable RF capacitors, and dynamic impedance matching controllers



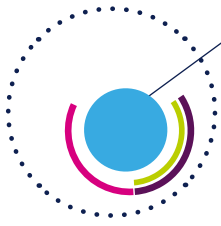

MEMS and Sensors



Enhanced user interfaces, gaming, OIS and much more

ST has shipped 10 billion micro-electromechanical sensors and has one of the industry's most extensive MEMS portfolio including accelerometers, gyroscopes, digital compasses, inertial modules, MEMS microphones, and environmental sensors including pressure, temperature, and humidity sensors.

5

Digital compasses: accurate compass heading in any conditions

ST's digital compasses include combo solutions, with an accelerometer and magnetic sensor integrated in a single LGA package, to give the possibility of designing a solution locating the magnetic sensor in the suitable position of printed circuit board (PCB).

Accurately detecting the direction and magnitude of external magnetic fields and using accelerometer measurements for tilt compensation, ST's digital compasses ensure very accurate compass heading even when the portable device is inclined.

ST's low-noise e-compasses offer better than 3 mGauss resolution and a wide range of full scales, all selectable by the user: up to $\pm 16g$ full scale acceleration and up to ± 16 Gauss magnetic field full scale. The compass family includes embedded self-test and smart power functionalities to minimize current consumption. The LSM303C is board- and software-compatible with the latest generation of accelerometers, thus offering maximum design flexibility.

KEY BENEFITS

- Superior sensing precision combined with low power consumption
- Extended magnetic-scale range
- Minimized measurement noise
- Very small package to address footprint reduction
- Temperature detection for advanced thermal drift compensation
- New possibilities for advanced navigation and location-based services in increasingly-portable consumer devices



Accelerometer + gyroscope SIP solution featuring multiple degrees of freedom

iNEMO inertial modules integrate complementary types of sensors to offer more compact, robust and easy-to-assemble solutions compared to discrete MEMS products. iNEMO solutions bring motion sensing systems to the level required for the most demanding applications, such as enhanced gesture recognition, gaming, augmented reality, indoor navigation, and localization-based services.

THE 6-AXIS ACCELEROMETER AND GYROSCOPE FAMILY

offers best-in-class accuracy, stability and resolution ensuring ultra-low-power, always-on activity for advanced tracking and smart motion capture.

Part number	Power consumption (mA) (high perf mode)	EIS/OIS features	Package size (mm)	Digital interface	Gyro ODR (Hz)
LSM6DS3H	1.1	yes/yes	2.5x3x0.83	I ² C/SPI + aux SPI for OIS/EIS	3333
LSM6DS3	1.25	yes/no	2.5x3x0.83	I ² C/SPI	1666
LSM6DS33	1.25	yes/no	3x3x0.86	I ² C/SPI	1666



2.5 x 3.0 x 0.83 mm



2.5 x 3.0 x 0.83 mm



3 x 3 x 0.86 mm

Digital gyroscopes

ST'S NEW DIGITAL GYROSCOPES ARE THE PERFECT SYNTHESIS OF ACCURACY AND DESIGN FLEXIBILITY

ST's latest gyroscopes feature excellent accuracy as a result of their unique and patented mechanical structure based on a single driving mass.

ST developed specific gyroscopes for addressing user interface (L3GD20H) or Optical Image Stabilization (L2G2IS) applications boasting superior output stability over time and temperature, removing the need for any further calibration on customer side.

They offer user-selectable full scales, ranging from ±100 to ±2000 dps, to cater for gaming, navigation, and OIS applications.

L3GD20H FEATURES

- Full scale ±245/±500/±2000 dps for UI, ±100/±200 dps for OIS
- I²C/SPI digital interface
- 16-bit data output
- 8-bit (UI) and 12-bit (OIS) temperature data output
- Wide supply voltage: up to 3.6 V
- Low-voltage compatible IOs (1.8 V)
- Embedded power-down and sleep modes
- Embedded temperature sensor
- Fast turn-on and wake-up
- User-enabled integrated filters
- Embedded 32 levels of 16-bit data output FIFO (UI)
- ECOPACK[®] RoHS and "Green" compliant
- High shock survivability



KEY BENEFITS

- High performance in terms of accuracy, and stability
- Design flexibility
- Extremely low power consumption lengthens battery life
- Temperature detection for advanced thermal drift compensation
- Enables faster system wake up

L2G2IS FEATURES

- $\pm 100/\pm 200$ dps full-scale range
- 3- and 4-wire SPI digital interface
- Embedded temperature sensor
- Integrated low- and high-pass filters with user-selectable bandwidth
- Wide supply voltage range: 1.71 to 3.6 V
- Embedded self-test
- Power-down and sleep modes for smart power saving
- ECOPACK®, RoHS and «Green» compliant

KEY BENEFITS

- Low noise and low latency device
- High stability in temperature reducing OIS algorithm complexity
- Embedded temperature sensor data can be accessed through SPI digital interface by application
- Robustness for ultrasonic cleaning process



DEVICE SUMMARY

Features	L3GD20H	L2G2IS
Typ. angular rate range (FS) (dps)	$\pm 245/\pm 500/\pm 2000$	$\pm 100/\pm 200$
Driving frequency (kHz)	20	20
Angular rate noise density ($^{\circ}/s/\sqrt{Hz}$)	0.011	0.006
ODR (Hz)	up to 800	9090
Programmable interrupts	2	N/A
Embedded FIFO	32 levels of 16-bit data output	N/A
Typ. current consumption (mA)	5	3.8
Supply voltage range (V)	2.2 to 3.6	1.71 to 3.6
Operating temperature range ($^{\circ}C$)	-40 to +85	-40 to +85
Applications	Gaming, pointing devices, navigation and motion control	Optical image stabilization (OIS)
Digital interfaces	I ² C/SPI	SPI (3/4 W)
Size (mm)	3 x 3 x 1	2.3 x 2.3 x 0.7

3-axis digital accelerometers

ST'S ULTRA-LOW-POWER ACCELEROMETERS FOR ADVANCED MOTION RECOGNITION AND POWER MANAGEMENT FEATURES

Housed in ultra-small packages and featuring excellent stability over time and temperature, ST's accelerometers are the ideal choice for all the most demanding consumer and industrial applications. The LIS3DSH, LIS3DH, LIS2HH12, LIS2DH12, LIS2DE12, and LIS2DS12 accelerometers are able to operate in ultra-low-power modes, thus lowering the overall system power consumption and extending the device's battery life. They also offer smart motion features, such as sleep-to-wakeup and return-to-sleep functions, to easily design the most intuitive and precise user interfaces.

KEY FEATURES

- Selectable full-scale up to $\pm 16g$
- High resolution
- Power-down, sleep and ultra-low-power operating modes for advanced power saving
- Smart embedded functions such as 4D/6D orientation detection auto wakeup and return-to-sleep
- Programmable interrupts and embedded FIFO
- Embedded digital functions (pedometer, step detector, step counter, and SMD)
- Embedded state machines for custom motion recognition (LIS3DSH)
- Digital interfaces: I²C/SPI
- Output data rates from 1 Hz to 6.4 kHz
- Embedded temperature sensor



KEY BENEFITS

- Extremely accurate motion-sensing capabilities in ever smaller and sleeker consumer gadgets
- Design flexibility
- Extremely low power consumption maximizes battery life
- Embedded FIFO for smart data storage and power saving
- State machines enable custom motion recognition inside the sensor, further reducing system complexity
- Temperature detection for advanced thermal drift compensation

DEVICE SUMMARY

Features	LIS2DS12	LIS3DSH	LIS3DH	LIS2HH12	LIS2DH12	LIS2DE12
Full scale	$\pm 2g/4g/8g/16g$	$\pm 2g/4g/8g/16g$	$\pm 2g/4g/8g/16g$	$\pm 2g/4g/8g$	$\pm 2g/4g/8g/16g$	$\pm 2g/4g/8g/16g$
Output resolution	14 bit	14 bit	12 bit	14 bit	12 bit	8 bit
Noise density ($\mu g/\sqrt{Hz}$)	120	150	220	130	220	350 $\mu g/\sqrt{Hz}$ ODR = 1600Hz
Output data rate (Hz)	1, 12.5, 25, 50, 100, 200, 400, 800, 1600, 3200, 6400	3.125, 6.25, 12.5, 25, 50, 100, 400, 800, 1600	1, 10, 25, 50, 100, 200, 400, 1250, 1600, 5000	10, 50, 100, 200, 400, 800	1, 10, 25, 50, 100, 200, 400, 1620, 5376	1, 10, 25, 50, 100, 200, 400, 1620, 5376
Programmable interrupts	2	2	2	2	2	2
Embedded FIFO	256 level	32 level	32 level	32 level	32 level	32 level
Supply voltage (V)	1.62 to 1.98	1.7 to 3.6	1.7 to 3.6	1.7 to 3.6	1.7 to 3.6	1.7 to 3.6
Temperature range (°C)	-40 to +85	-40 to +85	-40 to +85	-40 to +85	-40 to +85	-40 to +85
Digital interfaces	I ² C/SPI	I ² C/SPI	I ² C/SPI	I ² C/SPI	I ² C/SPI	I ² C/SPI
Size (mm)	2 x 2 x 0.86	3 x 3 x 1	3 x 3 x 1	2 x 2 x 1	2 x 2 x 1	2 x 2 x 1
Advanced digital functions	Basic function and pedometer, step detector and step counters, tilt function, sensor hub, and always-on experience	Basic function and programmable motion detection by FSM	Basic function: 6D/4D orientation detection, free-fall detection, motion detection, click - double click, and wake up	Basic function and anti-aliasing filter: 6-axis detection, 6D/4D orientation detection	Basic function: 6D/4D orientation detection, free-fall detection, motion detection, click - double click, and wake up	Basic function: 6D/4D orientation detection, free-fall detection, motion detection, click - double click, and wake up

MEMS pressure sensors

MEMS PRESSURE SENSOR: 260-1260 hPa ABSOLUTE DIGITAL OUTPUT BAROMETER

STMicroelectronics LPS25HB and LPS22HB pressure sensors integrate ST's consolidated technology with the new fully molded package to further improve robustness, reliability, and moisture resistance while reducing package thickness.

With their ultra-low height of 0.76 mm, LPS25HB and LPS22HB sensors offer high design flexibility and easy implementation into multi-functional applications: from smartphones, tablets, and wearable technology such as sports watches, smart watches, fitness bands, and Internet-of-Things (IoT) products.

APPLICATIONS

- Weather forecast
- Barometric altitude
- Ascent/descent detection
- Vertical speed indication
- Indoor navigation (floor detection)
- Enhanced GPS navigation

KEY FEATURES

- 260 to 1260 hPa digital output barometer
- Current consumption: 4 μ A
- Selectable ODR from 1 to 25 Hz
- SPI and I²C
- Embedded FIFO
- Supply voltage: 1.7 to 3.6 V
- Package: 2.5 x 2.5 x 0.76 (typ.) or 2 x 2 x 0.8 (max.) mm

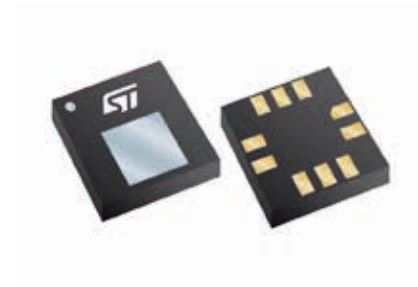

Touch sensing

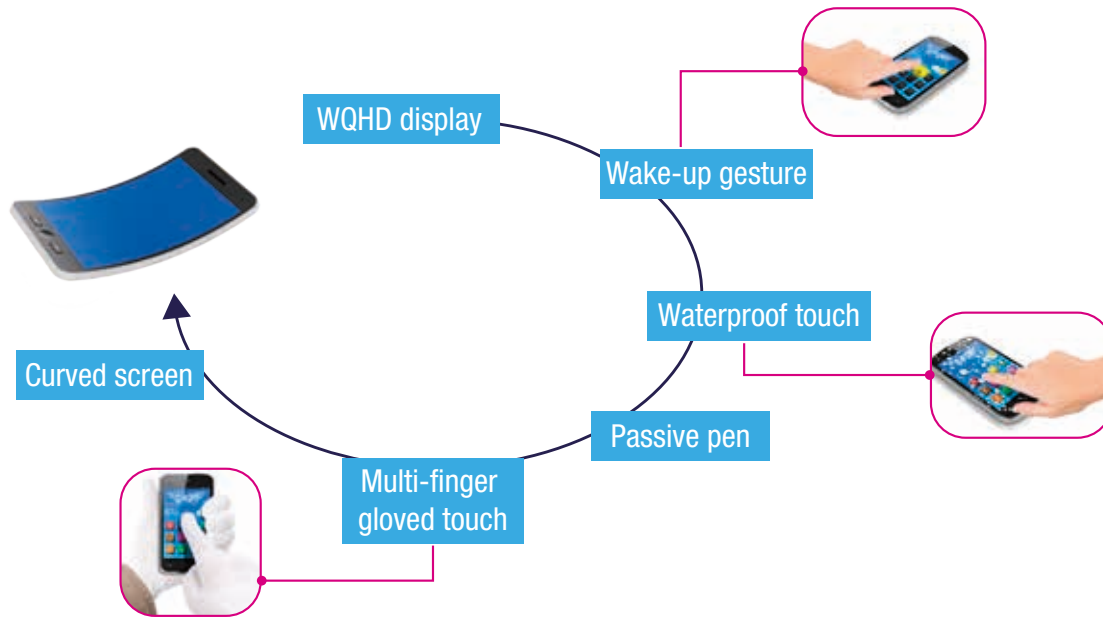

ULTRA-LOW POWER CAPACITIVE MULTI-TOUCH SCREEN CONTROLLER FOR 2" TO 13" SCREENS

FingerTip capacitive touchscreen controller

FingerTip provides an optimal mix of low power, small size, low external part count and versatile features with unmatched true multi-touch performance in a single-chip touchscreen controller.

The touchscreen controller can detect, classify, and track 10 finger touches with fast a report rate and response times.

The touch acquisition analog front-end has a wide dynamic range capable of coping with touchscreens of different sizes and configurations.

This offers the flexibility to use FingerTip with multiple touchscreens using different ITO designs and overlay materials. One- or two-layer ITO sensors are supported using glass or PET substrates. FingerTip provides support for curved displays through proprietary node compensation hardware.

FingerTip's low-noise capacitive analog front-end provides enhanced noise suppression capabilities for various noise sources such as display, 3-phase noise and severe common mode noise introduced by battery chargers.

The device utilizes ST proprietary hardware and firmware techniques to significantly reduce power in low-power active and low-power idle modes, and incorporates multiple TX driving methods that can further boost the SNR and report rate.

Advanced features

- Multi-mode sensing technology: Detects water on the top of the screen without false touch or line breaking
- Multi-finger glove operation
- Small passive stylus

All types of SYNC mode (HSYNC and VSYNC) support, which enables touch sampling to be synchronized with the display SYNC signal to work even with quad high definition displays.

The main processor implements a powerful 32-bit ARM Cortex-M3 core with Flash memory that is capable of providing a high level of overall touch performance in terms of noise rejection, response time, and power consumption.

The device supports an I²C serial interface, I²C master interface, HID over I²C interface, and SPI interface for greater flexibility.

KEY FEATURES

- Touch screen size with round or square form factor
- Support all types of Touch ITO
- I²C interface
- Ultra-low power modes for longer battery life
- Small and thin QFN (4 x 4 x 0.4 mm)
- Scan rate > 150 Hz
- High SNR
- Noise immunity to all sources
- GPIO for button support
- Support for multi-finger, thick glove, wet fingers and 1mm passive pen touches

Temperature sensors

DIGITAL TEMPERATURE SENSOR

STTS751

ST's digital temperature sensors are high-precision CMOS ICs with a delta-sigma analog-to-digital converter (ADC) and I²C compatible serial digital interface. The on-board delta-sigma ADC converts the measured temperature to a digital value that is calibrated in degrees Celsius. These temperature sensors feature low power consumption, up to 12-bit resolution and can operate over a temperature range as wide as -40 to +125 °C.

KEY FEATURES

- Accuracy: ±1.0 °C (typ.), ±1.5 °C (max.) from 0 to +85 °C
- Operating voltage: 2.25 to 3.6 V
- Operating temperature: -40 to +125 °C
- Dual alarm
- Programmable resolution
- Tiny packages
UDFN-6L (2 x 2 mm),
SOT23-6L (1.69 x 2.9 mm)
- 9- to 12-bit resolution
- Low operating current: 50 µA (typ.)
- Low standby current: 3 µA (typ.)
- One-shot mode for power saving
- Supports 400 kHz serial clock

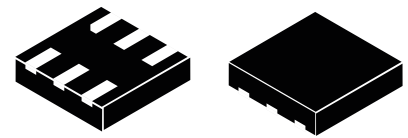

UDFN-6L, 2 x 2 x 0.5 mm

ANALOG TEMPERATURE SENSOR

STLM20 ultra-low-power precision temperature sensor

The analog temperature sensors feature ultra-low power consumption and provide superior linearity at much lower currents than a high accuracy thermistor and can operate over a temperature range as wide as -55 to +130 °C. They are ideal for regulating the gain of the power amp of any RF device including eReader, GPS devices, and medical instrumentation, where low power, small size, accuracy, and linearity over the full temperature range are fundamental.

KEY FEATURES

- Precision analog voltage output temperature sensor
- ±1.5 °C temperature accuracy at 25 °C
- Ultra-low quiescent supply current:
 - 4.8 µA (typ.), 8.0 µA (max.)
- Operating voltage range: 2.4 to 5.5 V
- Operating temperature range: -55 to 130 °C
- Packages: ultra-small
UDFN-4L (1 x 1.3 mm),
SOT323-5L (2 x 1.25 mm)

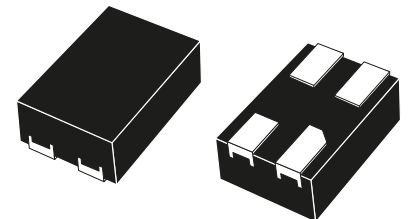

UDFN-4L, 1 x 1.3 x 0.5 mm



Imaging solutions



VL6180X combines an IR light source, a proximity sensor and an ambient light sensor in a single integrated module

12

STMicroelectronics offers a family of high-accuracy and target-independent ranging sensors, leveraging ST's own patented technology called FlightSense™ using the Time-of-Flight (ToF) principle. ST's family of products featuring high performance, small footprint and low power consumption is ideally suited for wireless applications and handheld devices.

First to enable high-volume production of fully integrated and small-sized Time-of-Flight products, ST's Imaging solutions are opening for more innovative use-cases and for user-experience enhancements for a wide variety of devices and application markets.

ST's internal manufacturing and supply chain guarantees supply as required by high-volume applications such as mobile phones or tablets.

KEY BENEFITS

- Fully integrated module: IR laser emitter, ranging sensor and ALS. No need for external LEDs
- Only SPAD (single photon avalanche diode) array-based product on market
- Absolute distance measurement (in millimeters, register output)
- Independent of target reflectance: works with dark colours, gloves
- Can work with coverglass (offset and crosstalk compensation)
- Accurate and low power

KEY APPLICATIONS

- Mobile devices
 - Proximity detection
 - Ambient light sensing
 - Simple but robust gesture control
- Home appliances
 - Power on/off, volume +/-
 - Collision avoidance for cleaning robots (wall and cliff)
 - User detection
 - Automatic faucet control
- Industrial
 - Object detection and ranging
 - Human-machine interface

KEY FEATURES

- 3-in-1 Time-Of-Flight module: proximity sensor, ALS (ambient light sensing) and basic gesture control
- Development tools and technical support
- Driver and API available
- Full set of documentation on www.st.com/VL6180X
- Proximity sensor NUCLEO expansion board compatible with STM32 NUCLEO family

SYSTEM ARCHITECTURE

The VL6180X contains an array of SPAD (Single Photon Avalanche Diode) detectors. The SPAD array forms part of an advanced system architecture that can detect the arrival of individual photons and hence calculate the time taken for the photon to leave the module, hit the target and then return back to the module. Actual distance measurement combined with signal amplitude allows simple, but robust, gesture recognition to enable multiple use cases.

Furthermore, the VL6180X's ultra-low-power system architecture is perfectly suited to the demanding requirements of wireless and consumer products.

MODULE DESIGN

All components needed to support the proximity sensor and ambient light sensor are embedded in the simple optical module. No mechanical gaskets or additional lens systems are required to complete the industrial design.

The module can be mounted on the host PCB using a standard reflow profile or flex attached.

Its unique time-of-flight properties allow the module to be hidden behind a wide variety of cover-glass materials. This enables very innovative product design with the possibility of removing the hole that normally forms part of the industrial design.

SYSTEM BLOCK DIAGRAM

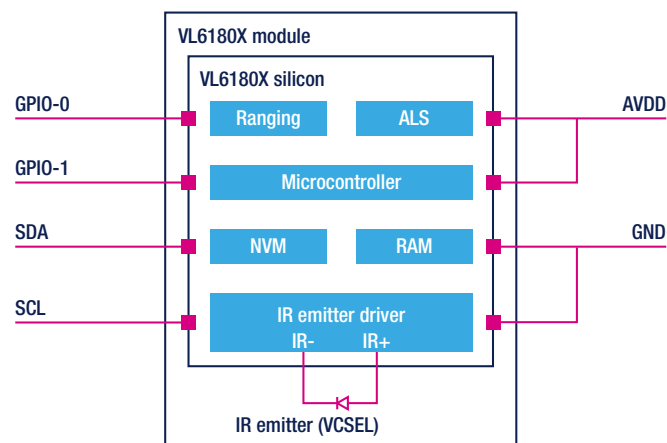

VL6180X MODULE



VL6180X NUCLEO EXPANSION BOARD



TIME-OF-FLIGHT PRINCIPLE

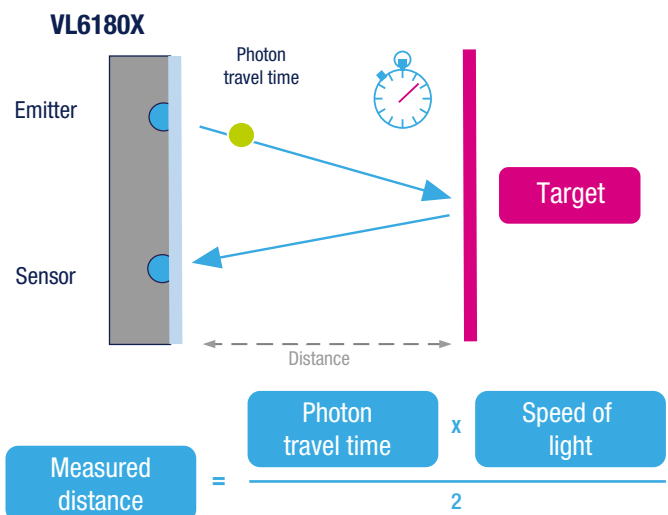

SENSORS AND HUMAN INTERFACE PRODUCTS

Accelerometers	
LIS2DS12	Ultra-low-power, high-performance 3-axis digital output accelerometer, embedded smart digital features, 2x2 LGA package, 12 bit
LIS3DSH	Ultra-low-power high-performance 3-axis nano accelerometer, embedding 2 finite-state machines
LIS3DH	Ultra-low-power, high-performance 3-axis digital output accelerometer, 3x3 LGA package, 12 bit
LIS2HH12	High-performance 3-axis digital output accelerometer, 2x2 LGA package, 14 bit
LISDH12	Ultra-low-power, high-performance 3-axis digital output accelerometer, 2x2 LGA package, 12 bit
LISDE12	Ultra-low-power, high-performance 3-axis digital output accelerometer, 2x2 LGA package, 8 bit
Digital gyroscopes	
L3GD20H	3-axis digital output gyroscope for User Interface
L2G2IS	2-axis digital output gyroscope for OIS
iNEMO inertial modules	
LSM6DS3H	3D accelerometer and 3D gyroscope, 2.5x3 LGA package, supporting multimode connections, high performance for OIS
LSM6DS3	3D accelerometer and 3D gyroscope, 2.5x3 LGA package, supporting multimode connections
LSM6DS33	3D accelerometer and 3D gyroscope, 3x3 LGA package
Digital compasses	
LSM303C	Ultra-compact, high-performance e-compass 3D accelerometer and 3D magnetometer module
Pressure sensors	
LPS25HB, LPS22HB	260 to 1260 mbar absolute digital output barometer
iNEMO engine sensor fusion libraries	
iNEMOEngine_LI3	A free software library for motion-detection system evaluation
iNEMOEngine_PI3P	A compiled software library with data-fusion algorithms for multiple sensor output processing
Proximity sensors	
VL6180X	Proximity sensor, gesture and ambient light sensing (ALS) module
Humidity and temperature sensor	
HTS221	Capacitive digital sensor for relative humidity and temperature
Digital / Analog temperature sensors	
STTS751	2.25 V low-voltage local digital temperature sensor
STLM20	Ultra-low-current 2.4 V precision analog temperature sensor
Touchscreen controllers	
FingerTip	Ultra-low power capacitive multi-touch screen controller for 2" to 13" screens
Display driver	
STLED524	5 x 24 dot intelligent matrix LED display driver

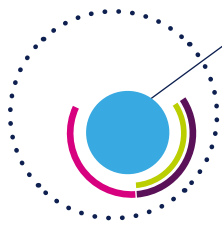

Audio solutions



MEMS microphones and audio subsystems

High-quality audio is the differentiating factor for multimedia-rich mobile platforms. ST manufactures state-of-the-art analog and digital microphones with MEMS technology enabling crystal-clear sound and conversations. Our audio amplifier portfolio ranges from class G headphone drivers to class D speaker drivers that deliver high-quality sound extremely efficiently. Customers can also tune the complete audio system with ST's APWorkbench™ software.

MEMS MICROPHONES

MEMS microphones target all audio applications where small size, high sound quality, reliability, and affordability are key. Our microphones meet price points set by the traditional electret condenser microphones (ECM), while featuring superior reliability and robustness. ST's MEMS microphones perfectly pair with our latest generation of Sound Terminal® audio processing devices, that feature a dedicated built-in interface for direct connection of a MEMS microphone, saving part count and cost.

HEADPHONE AMPLIFIERS

Very high audio quality and low power consumption with capacitor-less class G architectures in tiny flip-chip packages.

SPEAKER AMPLIFIERS

Wide range of filterless class D audio amplifiers for mono and stereo applications with gain control, 3D sound effects, and anti-clipping.

KEY FEATURES

- Microphones: Excellent SNR (>63 dB) with full frequency response (20 Hz to 20 kHz) in small package (3 x 4 x 1 mm)
- Headphone and speaker amplifiers: High audio quality (PSRR, SNR, THD+N) for headsets in high-efficiency class G topologies; high power in low battery voltages with Class D technology
- Audio system design: ST's APWorkbench™ software to browse through ST's audio portfolio, and select, control and tune the complete audio system easily and accurately

FEATURED PRODUCTS

HIGH-PERFORMANCE, LOW-POWER DIGITAL MEMS MICROPHONE WITH 63 DB SNR

MP34DT01/ MP34DT01-M

The MP34DT01 and MP34DT01-M are ultra-compact, low-power, omnidirectional, digital MEMS microphones built with a capacitive sensing element and an IC interface. The sensing element that detects the acoustic waves is manufactured using a special silicon micromachining process dedicated to producing audio sensors. The IC interface is manufactured using a CMOS process so that a dedicated circuit may be designed to provide a digital signal externally in PDM format. The MP34DT01 and MP34DT01-M have an acoustic overload point of 120 dB SPL with a 63 dB signal-to-noise ratio and -26 dBFS sensitivity. The MP34DT01-M is assembled in metal cap package.



KEY FEATURES

- Single supply voltage
- Low power consumption
- 120 dB SPL acoustic overload point
- 63 dB signal-to-noise ratio
- Omnidirectional sensitivity:
 - -26 dBFS sensitivity
- PDM output
- HCLGA package
- Top port design
- SMD compliant
- EMI shielded

TOP PORT MEMS AUDIO MICROPHONE WITH ANALOG OUTPUT IN 3.35 X 2.5 X 0.98 METAL PACKAGE

MP23AB02B

The MP23AB02B is a compact, low-power microphone built with a low-profile sensing element.

The sensing element, capable of detecting acoustic waves, is manufactured using a specialized silicon micromachining process to produce audio sensors.

The MP23AB02B has an acoustic overload point of 125 dB SPL with a 64 dB signal-to-noise ratio.

The MP23AB02B is available in a package compliant with reflow soldering and is guaranteed to operate over an extended temperature range from -40 to +85 °C.

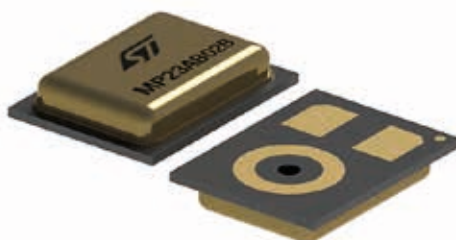

KEY FEATURES

- SNR: 64 dB
- Sensitivity: -38 dBFS
- Acoustic overload point: 125 dB SPL
- Supply voltage: 1.6 to 3.6 V
- Current consumption: 150 μ A
- Flat frequency response
- Size: 3.35 x 2.5 x 0.98 mm



Mobile security solutions

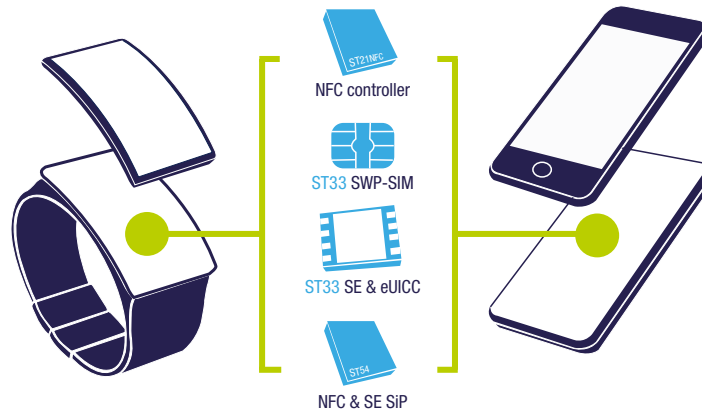

NFC and secure element

Near field communication (NFC) technology is at the heart of an expanding spectrum of easy-to-use, intuitive, contactless applications. These target a broad range of electronics devices such as handsets, wearables, and other consumer electronics devices.

STMicroelectronics provides a global offer of products and solutions for NFC enablement. This includes state-of-the-art NFC controllers and a set of secure 32-bit Flash-based microcontrollers to address SWP-SIM, embedded secure elements (SE), M2M SIM, and eUICC. Secure solutions are delivered as discrete ICs, or system-in-package for optimized solutions.

NFC CONTROLLER

The ST21NFC product family is based on a microcontroller architecture with embedded EEPROM and multiple connectivity channels. The devices comply with all relevant standards, that address all possible NFC use cases.

- ISO/IEC 14443 A, B, F
- ISO/IEC 15693 and ISO/IEC 18092 compliant
- Active load modulation is already included in the above standards
- Extremely low power consumption
- Up to 3 SWP for UICC, eUICC and SE
- Card, reader/writer and peer-to-peer modes
- Power by RF field capability

SECURE ELEMENT, SWP-SIM, EUICC

The ST33 family has been designed to meet the advanced EAL5+/EMVCO security and performance requirements, combining the latest Flash technologies with the highest security levels on the secure ARM® Cortex™ SC300 core.

- 32-bit ARM® SecureCore® SC300™ core
- From 512 Kbytes to 1.2 Mbytes of Flash memory
- 1.8 V, 3 V and 5 V V_{CC} range
- High-performance cryptographic engine
- SWP, ISO and SPI interfaces
- EMVCo and CC-EAL5+ certifications
- Optional MIFARE® and M4M® support
- Wafer, micro-module, DFN8, and WLCSP packages

KEY BENEFITS

- No compromise on security
- Multiple application support
- Design flexibility
- One stop shop

SECURE ELEMENT

Lowering the complexity of secured OS management, the ST33 secure element is an ST33 with a pre-loaded state-of-the-art Global Platform GP2.2 OS. A wide range of configurations are available to meet market demand.

- Java JC 3.0.1
- Global Platform GP2.2 Amendment A, C, D, E
- Up to 600 Kbytes of user Flash memory
- EMVCo and CC EAL5+
- Multiple TSM support
- Optional MIFARE® Classic, DESFire® and Mifare4Mobile®

NFC CONTROLLER SECURE ELEMENT COMBO

As part of global NFC offer and to minimize the PCB footprint impact of NFC, the ST54 product family is a system in package made by stack an ST21NFC NFC controller and an ST33 secure element.

- Turnkey stack solution
- All NFC use cases supported
- BGA 4.0 x 4.0 x 0.9 mm
- Pin compatibility with ST21NFC

NFC COMPONENTS AND ARCHITECTURES (*)

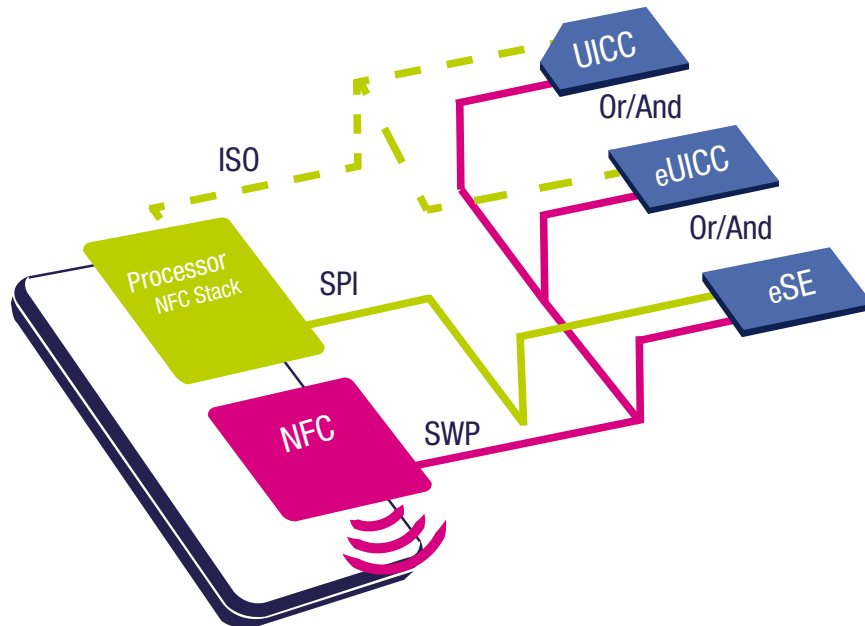

(*) ST also offers NFC tags, please refer to section NFC tags

NFC AND SECURE ELEMENT PRODUCTS

Accelerometers	
ST21NFCB	NFC controller with I ² C, SPI, GPIOs and SWP interfaces Multiple secure element capable with automatic AID routing via SWP
ST21NFCC	NFC controller with I ² C, SPI, GPIOs and SWP interfaces Multiple secure element capable with automatic AID routing via SWP, supporting active booster front-end
ST33G1M2	Secure MCU with 32-bit ARM® SecurCore® SC300™ CPU, MIFARE®, SWP, ISO, SPI, GPIO interface and high-density Flash memory (1280 Kbytes)
ST33H768	Secure MCU with 32-bit ARM® SecurCore® SC300™ CPU, MIFARE®, SWP, ISO, SPI, GPIO interface and high-density Flash memory (768 Kbytes)
ST54D	SIP (System In Package) with NFC controller, 32-bit secure microcontroller and Global Platform GP2.2 OS
ST54E	SIP (System In Package) with NFC controller, 32-bit secure microcontroller and Global Platform GP2.2 OS, supporting RF front-end booster

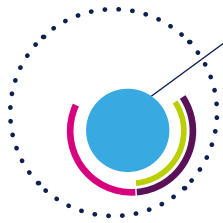

NFC tags

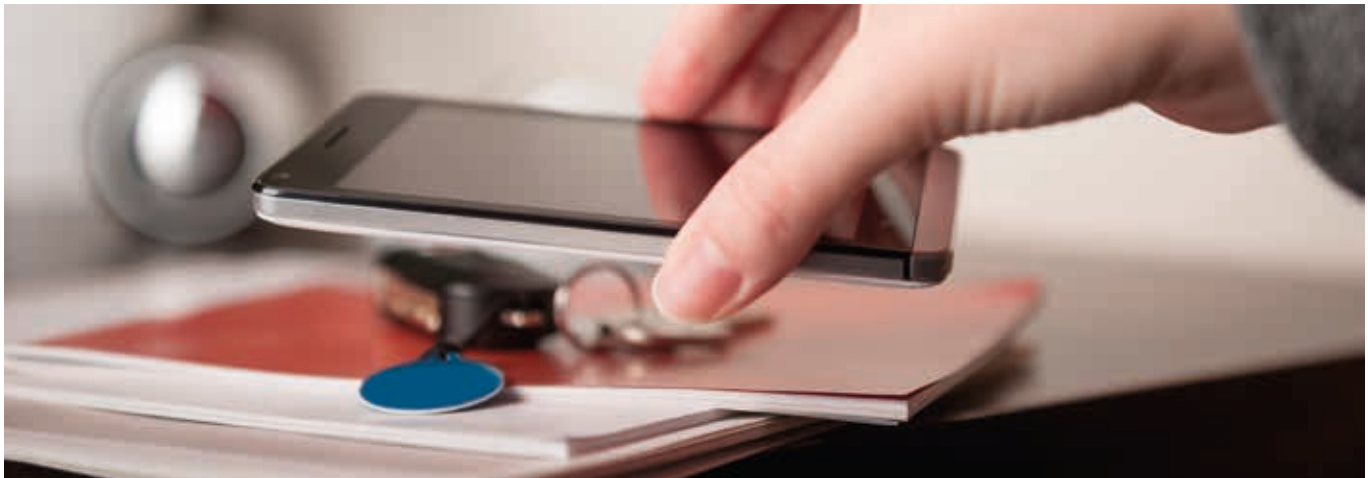

NFC/RFID tags with ISO/IEC 14443 Type A RF interface, NDEF memory and 128-bit password protection

ST's ST25TA ICs provide the NFC Forum Type 4 Tag RF interface and built-in NDEF (NFC Data Exchange Format) message support. The embedded EEPROM memory density spans from 512 bits to 64 Kbits, covering a wide spectrum of applications including content-rich virtual business cards and smart signs. The ST25TA series delivers state-of-the-art RF performance and features a user-programmable digital CMOS General Purpose Output (GPO) that eliminates the need for an external component to trigger the host wake-up.

KEY BENEFITS

- Wide memory density options from 2 K to 64 K bits
- High-reliability EEPROM
- Built-in NDEF format support
- Strong password protection scheme
- Read or Write operations counter
- Flexible user-programmable GPO

KEY APPLICATIONS

- Smart posters
- NFC business cards
- Consumer electronics
- Wireless handover
- Gaming
- Industrial
- Traceability
- Wearable electronics

KEY FEATURES

- ISO/IEC 14443 Type A
- NFC Forum Type 4 Tag
- 13.56 MHz carrier frequency
- 512-bit, 2-Kbit, 16-Kbit and 64-Kbit densities
- 56-bit unique identifier
- 128-bit password protection
- Optional 20-bit counter
- Optional RF status digital output
- 5- and 8-lead UDFPN packages
- Bumped wafer die form packages
- 25 or 50pF tuning capacitance
- 200 years data retention
- 1 million write erase cycles

DEVICE SUMMARY

Part number	RF interface	Memory size	Data protection (128 bit password)	20 bit Counter	Package	RF status output
ST25TA512	ISO 14443A Type A	512 bits	Yes	Yes	SBN12 *	No
ST25TA02K	ISO 14443A Type A	2 Kbits	Yes	Yes	SBN12 *	No
ST25TA02K-P	ISO 14443A Type A	2 Kbits	Yes	Yes	UFD5FN5 and 8, SBN12 *	Yes
ST25TA16K	ISO 14443A Type A	16 Kbits	Yes	No	SBN12 *	No
ST25TA64K	ISO 14443A Type A	64 Kbits	Yes	No	SBN12 *	No

* SBN12: Sawn and Bumped wafer (die form), 120µm thickness

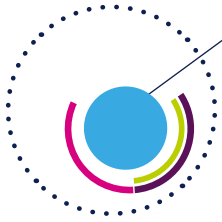

Serial EEPROM

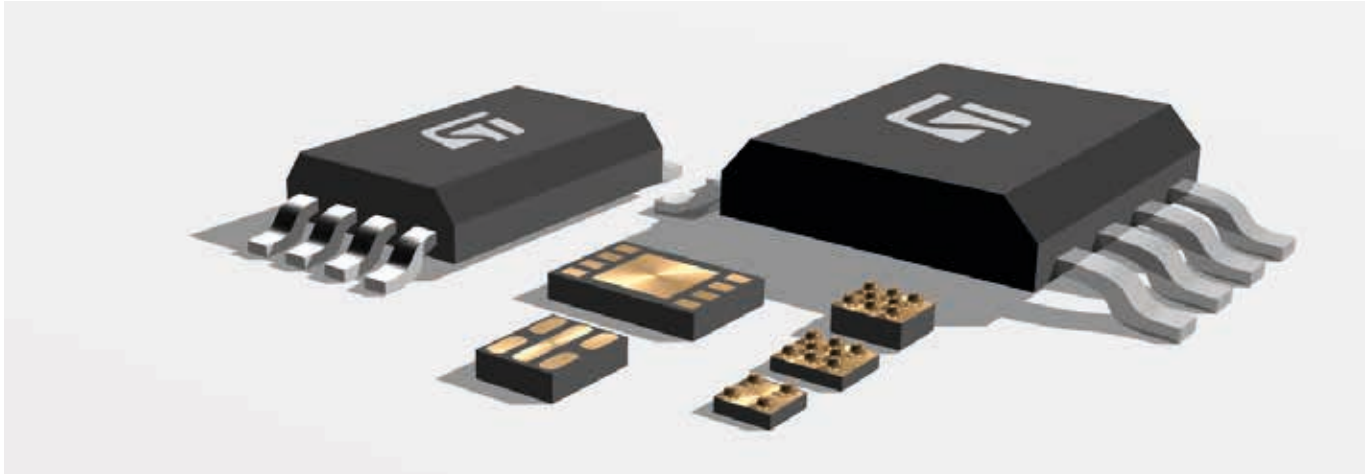

ST's EEPROMs perfectly meet the major market requirement of flexibility, with a complete portfolio of densities from 2 Kbits up to 2 Mbits. I2C and SPI buses are offered in standard and miniature packages, accommodating power supplies from 1.6 to 5.5 V. ST guarantees its portfolio at 4 million E/W cycles per byte, 100 million cycles per device, and 200 years data retention.

Standard EEPROM in WLCSP are recommended each time non-volatile memory is required and available board space is less than 1 mm²:

- Communication modules
- Display drive modules
- Camera modules

UDFPN5 package (1.4 x 1.7 mm) with reduced footprint is also available.

This makes ST's EEPROMs the first choice for parameter and data management in Mobile applications.



Million cycles per byte
Ideal choice for heavy cycling



WLCSP package
Wide portfolio with high compatibility



Less than 1 mA
Low power consumption compared
to other NVMs



UDFPN5 package
16-Kbit up to 128-Kbit I²C

KEY BENEFITS

- Optimized footprint
- Thinnest profile
- Protect the whole/defined blocks of the EEPROM by software, against undesirable write instructions even if device has no hardware write protect pin (4-ball design)
- Mount several EEPROMs on the same I²C bus, even if device has no chip enable pin (4-ball design)

KEY FEATURES

- Reduced dimension at 0.72 mm² for 128-Kbit EEPROM
- Thickness less than 0.3 mm
- Software write protect feature
- Device select code option

WLCSP series	Part number	Memory density	Software write protect	Dimension		Profile max. (mm)	Ball size typ. (mm)	Pinout compatibility	Min pitch (mm)	Back side coating	Device select code
				max. X (mm)	max. Y (mm)						
SWP 4-ball design	M24C32S-FCU6T/T	32-Kbit	Yes	0.853	0.853	0.300	0.185	M24C64S	0.4 x 0.5	No	1010 001x
	M24C32S-FCU6T/TF	32-Kbit	Yes	0.853	0.853	0.330	0.185	M24C64S	0.4 x 0.5	Yes	1010 001x
	M24C64S-FCU6T/T	64-Kbit	Yes	0.853	0.853	0.300	0.185	M24128S	0.4 x 0.5	No	1010 001x
	M24C64S-FCU6T/TF	64-Kbit	Yes	0.853	0.853	0.330	0.185	M24128S	0.4 x 0.5	Yes	1010 001x
	M24128S-FCU6T/T	128-Kbit	Yes	0.853	0.853	0.300	0.185	M24C64S	0.4 x 0.5	No	1010 001x
	M24128S-FCU6T/TF	128-Kbit	Yes	0.853	0.853	0.330	0.185	M24C64S	0.4 x 0.5	Yes	1010 001x
	M24C32T-FCU6T/TF	32-Kbit	Yes	0.853	0.853	0.330	0.185	M24C64T	0.4 x 0.5	Yes	1010 000x
	M24C64T-FCU6T/TF	64-Kbit	Yes	0.853	0.853	0.330	0.185	M24128T	0.4 x 0.5	Yes	1010 000x
	M24128T-FCU6T/TF	128-Kbit	Yes	0.853	0.853	0.330	0.185	M24C64T	0.4 x 0.5	Yes	1010 000x
Compatible 4-ball design	M24C08-FCT6TP/T	8-Kbit	No	0.715	0.705	0.330	0.185	M24C16	0.4 x 0.4	No	1010 0zzx
	M24C16-DFCU6TP/K	16-Kbit	No	0.745	0.839	0.300	0.185	M24C08	0.4 x 0.4	No	N/A
	M24C32-FCU6TP/TF	32-Kbit	No	0.815	0.694	0.345	0.160	M24C64-FCU	0.4 x 0.4	Yes	1010 000x
	M24C32M-FCU6T/TF	32-Kbit	No	0.815	0.694	0.345	0.160	M24C64M-FCU	0.4 x 0.4	Yes	1010 100x
	M24C64-FCU6TP/TF	64-Kbit	No	0.815	0.694	0.345	0.160	M24C32-FCU	0.4 x 0.4	Yes	1010 000x
	M24C64M-FCU6T/TF	64-Kbit	No	0.815	0.694	0.345	0.160	M24C32M-FCU	0.4 x 0.4	Yes	1010 100x



Signal conditioning



Operational amplifiers and comparators for handheld devices

STMicroelectronics is a leading supplier of power-saving and space-saving op amps and comparators offering a wide portfolio of products.

ST's op amps and comparators enhance the signal chain by being the perfect companion chips for ST's microcontrollers and analog sensors.

In addition to providing industry-standard solutions supported with a large production capability, ST offers upgraded versions of op amps and comparators that include better accuracy, standby functions and tiny packages. On top of upgraded versions, ST also offers high-performance zero-drift and nanopower op amps and comparators.

- Heart-rate monitoring by light reflection
- Gesture recognition by electromyography
- Infrared emitter-receiver for remote control
- Ultra-violet light measurement
- Air quality sensor signal conditioning
- Wireless battery charging



DEVICE SUMMARY

Part number	Description	Supply current (μ A)	Package
TSU101, TSU102, TSU104	Nanopower 5 V CMOS op amp	0.58	SC70-5, DFN8 2 x 2, QFN16 3 x 3
TSZ121, TSZ122, TSZ124	Very high accuracy (5 μ V) zero drift micropower 5 V op amp	31	SC70-5, DFN8 2 x 2, QFN16 3 x 3
TSV711, TSV712, TSV714	High accuracy ($V_{io} < 200 \mu$ V) micropower CMOS op amp	10	SC70-5, DFN8 2 x 2, QFN16 3 x 3
TSV731, TSV732, TSV734	High accuracy ($V_{io} < 200 \mu$ V) micropower CMOS op amp	60	SC70-5, DFN8 2 x 2, QFN16 3 x 3
TSV991A	Rail to rail input/output high merit factor op amp	820	DFN6 1.3 x 1.6
TS881, TS882, TS884	Rail-to-rail 0.9 V nanopower comparator	0.21	SC70-5, DFN8 2 x 2, QFN16 3 x 3



Microcontrollers

STM32 SMART AND WIDE CHOICE OF SOLUTIONS FOR WEARABLE DEVICES



By choosing one of ST's microcontrollers for mobile application, you gain from our leading expertise in MCU architecture, technology, multi-source manufacturing and support. ST's product portfolio contains a comprehensive range of microcontrollers, from robust, low-cost 8-bit MCUs, 32-bit ARM®-based Cortex®-M0 and M0+, Cortex®-M3, Cortex®-M4 and up to Cortex®-M7 Flash microcontrollers with a great choice of peripherals. Leveraging its wide and market-proven portfolio, ST offers a selection of STM32 microcontrollers perfectly fitting wearable devices targeting applications such as:

- Healthcare and consumer fitness and wellness
- Medical
- Portable infotainment
- Monitoring and safety in industrial applications

In these applications, high precision, low power consumption, compact form factor, and outstanding performance are a must and ST's products take into account the needs of the most recent and innovative wearable devices.

- Wide range of processing performance
- Low power and energy efficiency
- Multiple and flexible power modes
- Wide voltage operation range
- Batch acquisition mode (BAM)
- LCD drivers
- Serial audio interfaces
- RTC with Calendar
- Multiple peripherals
- Advance analog features
- WLCSP packages
- Small and thin UQFN packages

24

8-bit MCUs

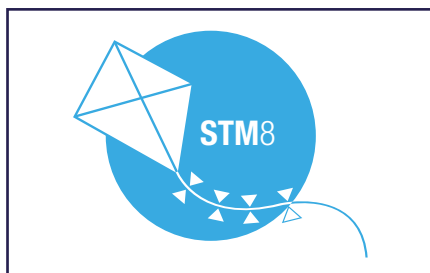

32-bit MCUs



Ultra-low-power

Mainstream

High-performance

ST MCU Finder: All ST MCUs in your hand

The ST MCU Finder app for mobile devices is the best way to explore the STM32 and STM8 portfolio of more than 700 references of microcontrollers and development boards.

Define the part that best fits your application with the powerful search engine: choose and save your search criteria, compare and sort the results. Instantly access technical documentation, key features, functional block diagrams, and prices for our MCUs and development tools. Share your results with colleagues and directly buy online at our distributors.

Download the complete documentation library and stay synced with the latest releases from ST.

Stay connected and keep up to date with the STM32 and STM8 world through our social media, community and news feeds.

Supported languages: English, Chinese (simplified and traditional), and Japanese.



STM32 – THE REFERENCE IN SENSOR HUBS



A complete microcontroller offer including ultra-low-power STM32L as well as high-performance and power-efficient STM32F401/411 to address sensor hub applications in smartphones, tablets, and wearable devices. STM32 sensor hub microcontrollers enable low power, low latency sensor fusion and implement an innovative batch acquisition mode (BAM) allowing ultra-low-power sensor data acquisition. The application range is wide and covers from simple activity trackers (suggestion) implementing a single accelerometer up to smartphones with 9-axis accelerometer, gyroscope & magnetometer combined with environmental sensor and audio with MEMS microphones. STM32 sensor hub microcontrollers are available with 3rd party motion processing libraries including Always-on sensor fusion, gesture recognition, activity & sleep monitoring, context awareness, and indoor navigation with map matching on both Android™ and Windows® platforms.

KEY FEATURES

- Cortex®-M0+, M3 and M4 devices
- Up to 100 MHz with FPU
- Up to 125 DMIPS, 339 CoreMark
- Up to 1 Mbyte of Flash memory and 128 Kbytes of RAM
- Batch Acquisition Mode (BAM)
- Current down to 87 µA/MHz in Run mode
- Current down to 300 nA in Stop mode
- I²C, SPI/I²S, USB, USART, and SDIO
- ADC and DFSDM (PDM to PCM)
- From WLCSP25 down to 2 x 2.2 mm

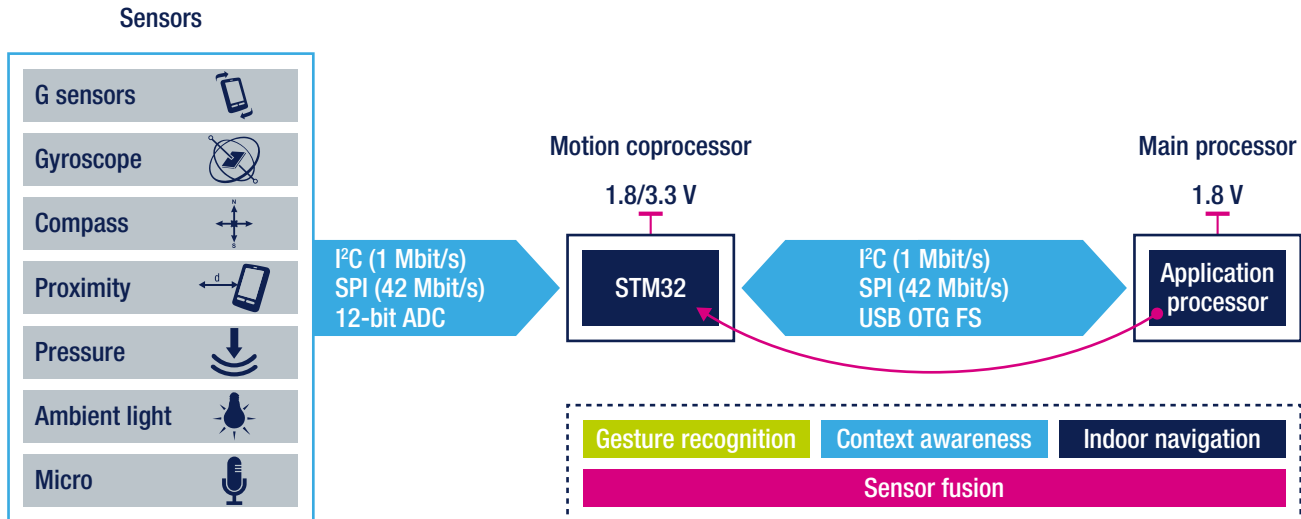

STM32 Dynamic Efficiency™

Less dynamic power
More performance



STM32L

Ultra-low-power MCUs

STM32 – THE REFERENCE IN ADVANCED GRAPHIC USER INTERFACES

Enhanced user experience with the Chrom-ART Accelerator™



STM32 high-performance products take full advantage of ST's proprietary Chrom-ART Accelerator™ to offer advanced graphic capabilities with minimum processing overhead.

Through the combination of processing acceleration, rich connectivity and optimized architecture, STM32 high-performance MCUs can handle both the demanding real-time processing and enhanced GUI that would otherwise require even more powerful – and more power-hungry – processors.

KEY FEATURES

- Chrom-ART Accelerator™ enabling efficient 2D copy, transparency effects and pixel format conversion independently from the main CPU
- MIPI-DSI controller supporting up to 720 p / 30 Hz resolution
- TFT-LCD controller supporting up to XGA resolution
- LCD parallel interface supporting 8080/6800 modes
- Power efficiency
- Maximum integration

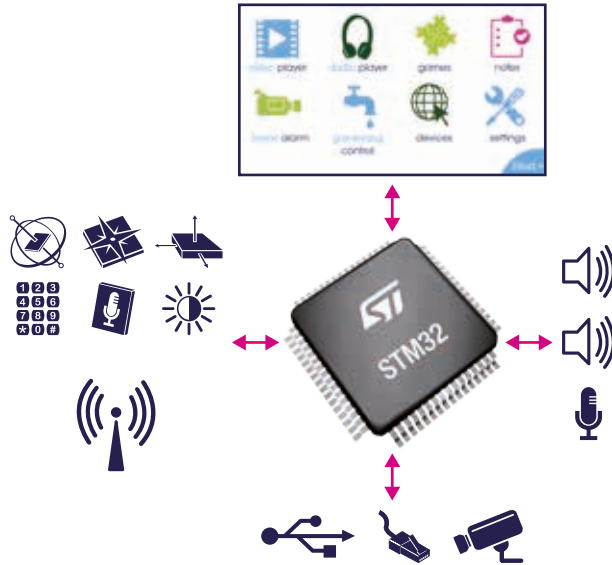

Support for the most advanced display technology

ST introduced the world's first MIPI-Display Serial Interface (DSI) -enabled microcontroller, opening the door to the most advanced displays from the mobile phone industry with higher pixel density and lower power consumption. Efficiently combining the Chrom-ART Accelerator™ and the new MIPI-DSI interface, ST's latest STM32 high-performance microcontrollers enable high resolution and enhanced user experience in the smallest product form factors.

Rich graphic ecosystem

The STM32 ecosystem offers a large choice of advanced graphic libraries taking the full advantage of the Chrom-ART Accelerator™ and simplifying your GUI design.



STM32 – THE REFERENCE IN AUDIO AND VOICE

Low-power audio DSP replacement



STM32L4 ultra-low-power and STM32F4 Dynamic Efficiency™ product lines combine advanced processing capabilities, outstanding low power consumption, and maximum integration to offer the ideal low-power audio and voice solutions for wearable

applications.

Leveraging ST's proprietary ART Accelerator™, the two product lines achieve zero wait state execution from internal Flash memory and deliver the full processing capabilities of the Cortex-M4 core running at up to 80 and 100 MHz. The Cortex-M4 DSP instruction set and the embedded floating point unit boost the performance capabilities, enabling advanced audio processing.

STM32L4 ultra-low-power and STM32F4 Dynamic Efficiency™ access lines achieve an outstanding 100 µA/MHz power consumption in Run mode and offer a Batch Acquisition Mode (BAM) enabling extended battery life by exchanging batches of data through communication peripherals while maintaining the rest of the system, including the CPU, in power-saving modes.

- 100/125 DMIPS
- DSP & FPU
- 100 µA/MHz in Run mode
- Batch Acquisition Mode
- Maximum integration

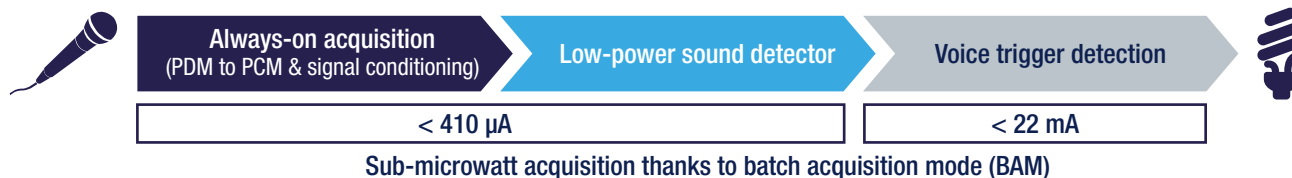
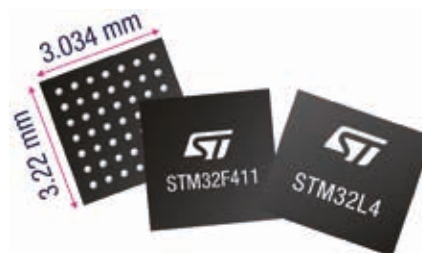

Wide range of processing performance, connectivity features and optimized software

ST's scalable STM32 microcontroller portfolio offers a wide range of processing performance and embedded SRAM sizes to meet a large number of audio application requirements. In addition, STM32 microcontrollers embed numerous audio interfaces with I²S, TDM and PDM support as well as audio dedicated PLLs to achieve audio accuracy.

STM32 microcontrollers also offer rich connectivity features with USB, SDMMC, camera, and display interfaces to meet the requirements for the most advanced applications.

Equally important, the STM32 software ecosystem facilitates the development of audio and voice applications by providing optimized internal and third-party audio software as well as hardware kits for prototyping. The software offer includes internal voice and audio codecs with MP3, AAC, WMA, Speex, ADPCM, G711, and G726 support. It also includes synchronization software, as well as audio post-processing solutions with SRC, equalization, bass management, smart volume control, and visualization. The STM32 ecosystem also gives access to a wide range of optimized third-party software including voice command solutions.



STM32 AND STM8 – THE REFERENCES IN TOUCH SENSING AND WIRELESS

STM32 and STM8L families: Integrated touch-sensing functions



Certain STM32 microcontrollers feature a full hardware touch-sensing acquisition module based on self-capacitance technology. These devices include several I/Os (up to 24 channels)

for integrating multiple touch keys and providing developers with a single-device solution.



Microcontroller-based I/Os internally coupled to touch sensing controller with up to 24 channels

Touch sensing acquisition < 5% CPU load. Based on charge transfer acquisition

Free-of-charge software libraries (C source code, firmware examples)

Adapted development tools: STM-STUDIO and STM32CubeMX

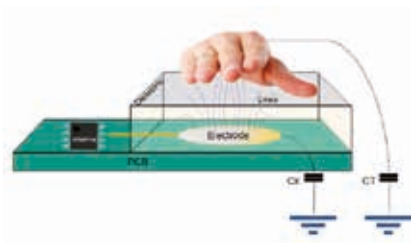

Self -capacitance

STM8 - STM32 families: Wireless charging system

From basic waveform generation for low-end devices up to complex waveform generation, our MCU mainstream series ensures extreme flexibility for the digital control of the coil.

Timers with flexible PWM generation, dead-time management, or complemented output.

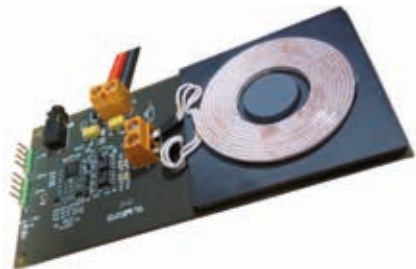

- ARM Cortex-M4 + FPU at 72 MHz – 90 DMIPS
- From 16 to 512 Kbytes of Flash memory
- Mixed-signals: CCM-SRAM, 16-bit $\Sigma\Delta$ ADC, hi-res timer



- ARM Cortex-M3 at 72 MHz – 61 DMIPS
- From 16 Kbytes to 1 Mbyte of Flash memory
- STM32 foundation: USB, Ethernet, CEC...



- ARM Cortex-M0 at 48 MHz – 38 DMIPS
- From 16 to 256 Kbytes of Flash memory
- Entry-level, cost-sensitive: 32-bit MCU at 32 cents, USB, CAN...



- STM8 core at 24 MHz
- From 4 to 128 Kbytes of Flash memory, plus E²Data
- Robust and reliable for basic functions

STM32 AND STM8 – THE REFERENCES IN POWER MANAGEMENT

STM8L family: 8-bit ultra-low-power MCU family

The STM8L, based on the 8-bit STM8 core, benefits from our proprietary ultra-low-leakage process, shared with the STM32L family, and features an ultra-low power consumption of 0.30 μA with the lowest power mode.



- Entry-level in ultra-low-power performance
- Targeting cost-sensitive applications



- Ultra-low-power market-proven solutions
- Best in class in ultra-low-power performance

STM32L family: the 32-bit ultra-low power MCU family

ST's ultra-low-power MCU platform is based on a proprietary ultra-low-leakage technology. STM32L0 (ARM® Cortex®-M0+), STM32L1 (Cortex-M3), STM32L4 (Cortex-M4) and the STM8L (8-bit proprietary core) represent a large range of devices addressing devices supplied from batteries or through energy harvesting and grant an optimized cost/performance ratio in all kinds of low-power applications.

This ultra-low-power platform with the industry's lowest current variation between 25 and 125 °C ensures outstandingly low current consumption at elevated temperatures. The MCUs reach the industry's lowest power consumption of 350 nA in Stop mode (with SRAM retention), while maintaining the wakeup time as low as 3.5 μs .

The new STM32L4 is the convergence of the ultra-low-power and high performance providing 100 DMIPS with DSP instructions and floating point unit, more memory (up to 1 Mbyte of Flash memory) and innovative features.

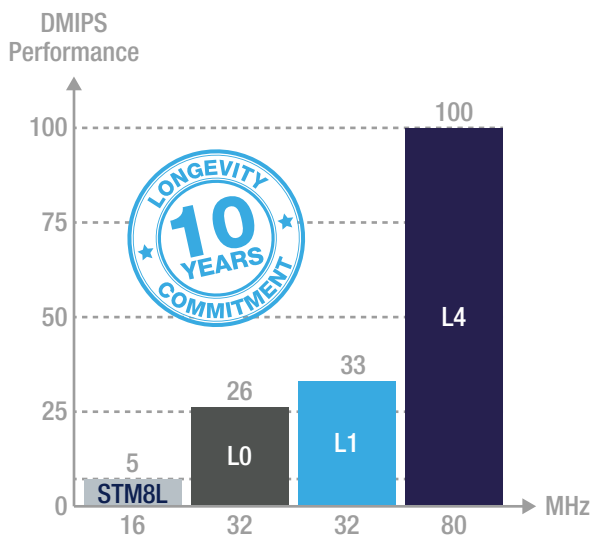

- 32-bit ARM Cortex-M4 core with floating point unit (FPU)
- From 256 Kbytes to 1 Mbyte of Flash memory
- Lowest power mode + RAM + RTC: 0.6 μA



- 32-bit ARM Cortex-M3 at 32 MHz
- From 32 to 512 Kbytes of Flash memory
- Lowest power mode + RAM + RTC: 1.2 μA



- 32-bit ARM Cortex-M0+ at 32 MHz
- From 8 to 192 Kbytes of Flash memory
- Lowest power mode + RAM + RTC: 0.8 μA



- 8-bit STM8 core at 16 MHz
- From 2 to 64 Kbytes of Flash memory
- Lowest power mode + RAM + RTC: 0.5 μA

STM32 - BRIDGING BETWEEN VOLTAGE DOMAINS



The STM32F0x8 and STM32F3x8 are specific low-voltage lines, helping overcome the challenges when adding a companion chip to a low-voltage host processor. The microcontrollers with Cortex M0 or Cortex M4 cores connect to the same digital power domain as the host, such as a 1.8 V power supply, while allowing on-chip peripherals to operate from higher voltages such as 3.3 V.

This combination of 1.8 V digital supply voltage and independent analog domain is particularly strong where a wide analog dynamic range is required, or for connecting directly to USB devices. It leads to an immediate cost advantage in mobile system architectures.

KEY FEATURES

- Multiple voltage domains in one chip
- No level shifter required
- Cortex-6M0 or Cortex-6M4
- Up to 90 DMIPS
- Small footprint (WCSP package down to 2.6 x 2.7 mm)

1.8V STM32

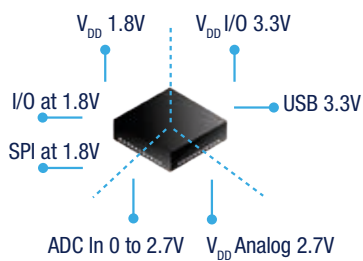

ADC of STM32F3x8 fully functional down to 1.865 V

1.8V STM32 bridges mobile platform subsystems



STM32 FOR ANTENNA TUNING



Thanks to their low pin count and ultra-small footprint, STM32F0 and L0 MCUs are ready to be used for simple auxiliary functions like flexible switches or control elements for antenna tuning. A rich peripheral set, wide operating range, and low power consumption values allow easy integration into mobile architectures, while 38 DMIPS give enough headroom for execution of control algorithms.

KEY FEATURES

- Low pin count QFN or WLCSP down to 4.4 mm²
- ARM Cortex-M0/M0+
- Up to 38 DMIPS
- Ultra-low current consumption

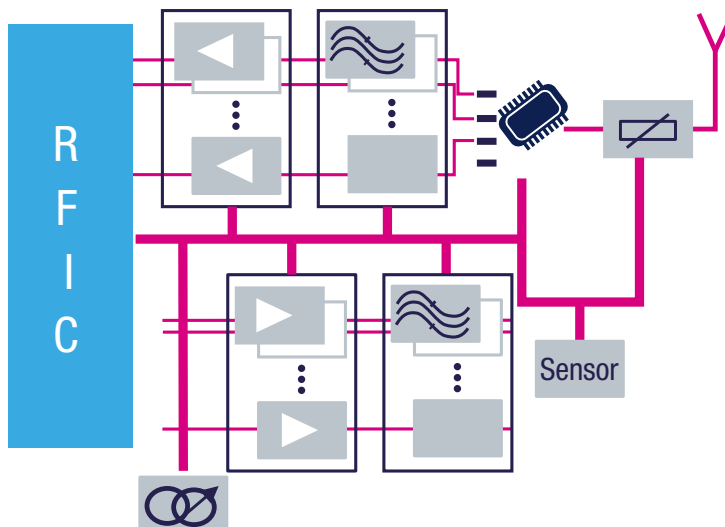

STM32CUBEMX POWER CONSUMPTION CALCULATOR WIZARD

With the STM32CubeMX configuration and initialization C code generator, select your chip and configure its peripherals and power supply. Then use its Power Consumption Calculator wizard to define a sequence of steps representing your application and analyze its power consumption and battery life results.

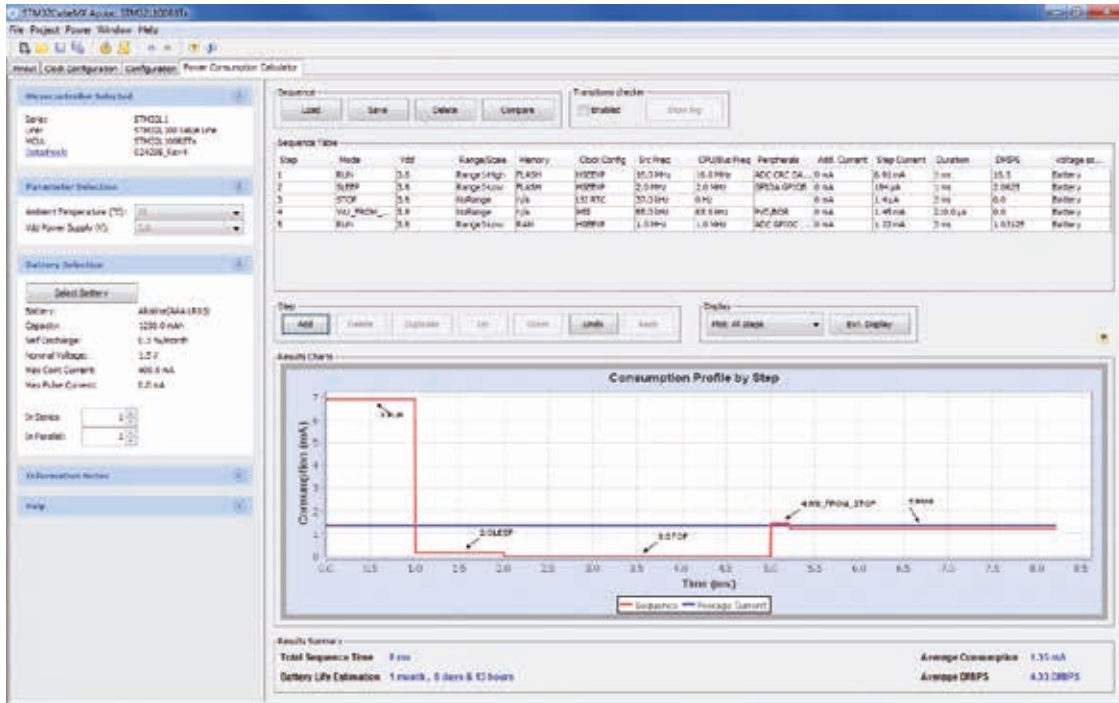



Radio frequency



Integrated passive devices for RF front-end antenna tuners

STMicroelectronics provides a wide RF product offer based on its integrated passive device (IPD) technology. IPD solutions based on glass substrate can offer a low parasitic and high-Q solution suitable for RF applications.

32

BALUNS

Baluns use ST's process to integrate high-quality RF passive components on a single glass substrate. As well as balanced/unbalanced conversion, they can also integrate a matching network in a footprint smaller than 1 mm² for the complete function.

DIPLEXERS

Cost- and size-efficient way to combine different complementary radio access paths into a single antenna, combine dual antenna feeds into single feeds or vice versa.

COUPLERS

Wideband couplers use ST's process to integrate high-quality RF passive components on a single glass substrate. They are intended for cellular applications (GSM, WCDMA, LTE). The range includes high-directivity, frequency selector and various coupling factor devices.

BAND-PASS FILTERS

Improves RF system performance through cost-efficient frequency filtering for cellular and ISM bands. RF IPDs provide high-performance RF solutions with low sensitivity to top shielding.

KEY BENEFITS

- Size: up to 80% board saving
- Cost: up to 40% cost saving
- Performance: improved RF immunity
- Low component height compared to low-temperature co-fired ceramic technologies
- Fewer board placement variation effects than discrete due to monolithic implementation
- High predictability from simulation enabling fast production response time

FEATURED PRODUCTS

SMALLEST HIGH-DIRECTIVITY WIDE-BAND COUPLERS WITH INTEGRATED ATTENUATORS

CPL and DCPL series

The CPL and DCPL are single- and dual-path antenna couplers used to closely monitor the forward and reverse power between the RF power amplifier and the antenna. By also integrating attenuators on coupled and isolated ports, the antenna couplers simplify circuit design while saving cost and PCB space. This additional integration is achieved using ST's proprietary integrated passive device (IPD) technology. Other types of couplers need separate attenuators.

In addition, insulated glass-substrate fabrication and wafer-level packaging reduce total device height and footprint compared to alternative low-temperature co-fired ceramic (LTCC) technology. ST now offers a range of couplers with various coupling levels and an integrated flattener.

KEY FEATURES

- 50-ohm nominal input/output impedance
- Operating frequency range: 700 to 2700 MHz
- Less than 0.2 dB insertion loss
- 20 to 40 dB typical coupling factor
- 25 dB typical directivity
- Component and PCB area:
 - 1.3 mm² for single path (incl. integrated attenuators)
 - 2.4 mm² for dual path (incl. integrated attenuators)

LOW-LOSS FREQUENCY DIPLEXER

DIP1524-01D3

The DIP1524-01D3 is a diplexer to separate GPS/Glonass signals and WLAN, Bluetooth or LTE band VII signals received on the same antenna. The 20 dB of attenuation between bands guarantees a good separation between GPS and the other RF signals. This diplexer uses ST's proprietary integrated passive device (IPD) technology developed to address the needs of passive integration in RF applications.

The DIP1524-01D3 is available in a flip-chip package with a pitch of 0.4 mm and does not require any extra PCB land around the component such as for LTCC packages. ST's solution is extremely small and saves over 50% more PCB space than conventional solutions.

KEY FEATURES

- Operating frequency range: 1600 MHz and 2400 to 2700 MHz
- 0.65 to 0.85 dB insertion loss
- 20 dB attenuation between bands
- -20 to -10 dB return losses
- Component and PCB area: 1.1 mm²
- 50% space saving versus LTCC solutions

DEVICE SUMMARY

Balun companion chip	
BALF-SPI-01D3	50 Ohm / Conjugate match balun to SPIRIT1 at 868/915 MHz
BALF-SPI-02D3	50 Ohm / Conjugate match balun to SPIRIT1 at 433 MHz
BAL-CC1101-01D3	50 Ohm / Conjugate match balun to CC1101 at 868/915 MHz
BAL-NRF01D3 + 0.8 pF	50 Ohm / Conjugate match balun to nRFnRF51422-QFAACA/C0, nRF51822-QFAACA/C0, nRF51822-QFABAA/A0
BAL-NRF01D3	50 Ohm / Conjugate match balun to nRF24LE1, nRF24AP2-1CH, nRF24AP2-8CH
BAL-NRF02D3	50 Ohm / Conjugate match balun to nRF51822-CEAA, nRF51422-CEAA, nRF51822-CDAB, nRF51822-CFAC, nRF51422-CDAB, nRF51422-CFAC
BALF-NRF01D3	50 Ohm / Conjugate match balun to nRF51422-QFAADAA/E00, nRF51422-QFABA00, nRF51822-QFAAFA0/GC0/G00, nRF51822-QFABB00
BALF-NRF01E3	50 Ohm / Conjugate match balun to nRF51422-QFAADAA/E00, nRF51422-QFABA00, nRF51822-QFAAFA0/GC0/G00, nRF51822-QFABB00, nRF51822-QFAAH00, nRF51822-QFABC00, nRF51822-QFACA00
BALF-2690-02D3	50 Ohm / Conjugate match balun to STLC2690
BALF-NRG-01D3	50 Ohm / Conjugate match balun to BlueNRG
DLPF-GP-01D3	Dual low-pass filter matched to GreenPeak GP540/560 RF IC
BAL-CC25-01D3	50 Ohm / Conjugate match balun to CC2540/44, CC2530/31/33, CC8520/21/30/31
BAL-CC25-02D3	50 Ohm / Conjugate match balun to CC2541

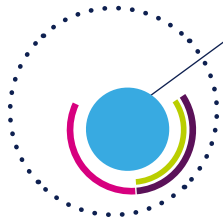

Smart antenna tuning



RF front-end antenna tuners

34

ST's smart antenna tuners offer high quality and high reliability RF tunable capacitors based on a ferroelectric material composed of baryum strontium and titanate (BST). This new tunable material allows the implementation of dynamic impedance matching for wireless handsets, which improves power amplifier efficiency and battery life while simultaneously reducing the likelihood of dropped or missed calls.

TUNABLE CAPACITORS

The STPTIC series of integrated tunable capacitors offers excellent RF performance, low power consumption, and high linearity required in adaptive RF tuning applications. Standard capacitor values ranging from 1.5 to 8.2 pF with a tuning ratio of 3.5:1 or 5:1. They are available in miniature chip-scale packages.

BST CONTROLLERS

The STHVDAC series are dedicated devices able to control tunable capacitors. They provide a high-voltage digital-to-analog converter (DAC), specifically designed to control and meet the wide tuning bias voltage requirement of BST tunable capacitors. Devices include SPI and MIPI RFFE serial interfaces.

KEY FEATURES

- High tuning range (5:1)
- Excellent RF linearity (IP3 > 65 dB)
- High Q factor (Q > 60 @ 1 GHz)
- Miniature CSP package with single footprint all PTIC values
- Battery-powered operation with low-power mode to reduce power consumption
- Compliant with MIPI RFFE interface for easy integration in mobile phone RF front-ends
- Dynamic control to optimize capacitor transition time thanks to turbo and glide modes

FEATURED PRODUCTS

SMALLEST HIGH QUALITY FACTOR RF TUNABLE CAPACITOR

STPTIC G2 series

The STPTIC G2 series of integrated tunable capacitors offers excellent RF performance, low power consumption, and high linearity required in adaptive RF tuning applications. These tunable capacitors are controlled through an extended bias voltage ranging from 1 to 24 V to provide a 5:1 tuning ratio. Capacitor values are range from 1.5 to 8.2 pF and are packaged in a 4-ball chip-scale package to allow designers to use a single footprint for all PTIC values. The G2 series features 70dBc 3rd harmonic rejection. When higher harmonic rejection is required, the L2 series is also available. The implementation of STPTIC G2 series of tunable capacitors in mobile phones enables significant improvement in term of radiated performance, making the performance almost insensitive to the external environment.

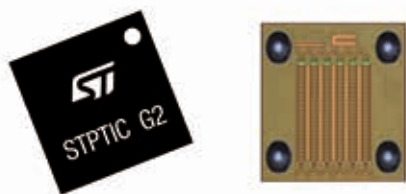

KEY FEATURES

- Miniature CSP package with single footprint all PTIC values
- Capacitor can be connected in a shunt or series configuration
- Capacitor bias is low frequency, low noise ANALOG control
- Number of capacitors in the stack is increased for higher linearity: 24 (standard) for G series (x24) and 48 (high)for L series
- High tuning range (5:1)
- Excellent RF linearity (IP3 > 65 dB)
- High Q factor $Q > 60 @ 1 \text{ GHz}$

NEW ANTENNA-TUNING CIRCUIT BOOSTS LTE SMARTPHONE PERFORMANCE

STHVDAC series

ST's STHVDAC-253M integrates three high-voltage DACs, allowing it to simultaneously optimize antenna performance in three different frequency bands. It supports all MIPI RFFE features such as extended mode, triggers, 26 MHz clock operation, and brings stronger signal/more bars, fewer dropped calls, faster downloads, and longer battery life. Housed in a flip-chip 0.4 mm pitch package, the STHVDAC-253M embodies the best-in-class antenna performance in a compact and cost-effective solution.



KEY FEATURES

- 16-bump chip-scale package (1.7 x 1.7 mm) with 0.4 mm pitch
- Battery-powered operation with low power mode to reduce power consumption
- Integrated boost converter with 3 programmable outputs (from 0 to 24 V)
- Compliant with MIPI RFFE interface for easy integration in mobile phone RF front-end
- Dynamic control to optimize capacitor transition time thanks to turbo and glide mode

DEVICE SUMMARY

Tunable capacitors F1 series	
STPTIC-xxF1M6	Tunable capacitor, 3.5:1 tuning ratio QFN 1.2x1.6 mm
Tunable capacitors G1 series	
STPTIC-xxG1H5	Tunable capacitor, 3.5:1 tuning ratio CSP 0.5 mm pitch
Tunable capacitors L1 series	
STPTIC-27L1M6	2.7 pF Tunable capacitor, 3.5:1 tuning ratio QFN 1.2x1.6 mm, high linearity
Tunable capacitors G2 series	
STPTIC-15G2C5	1.5 pF Tunable capacitor, 5:1 tuning ratio CSP 0.4 mm pitch
STPTIC-27G2C5	2.7 pF Tunable capacitor, 5:1 tuning ratio CSP 0.4 mm pitch
STPTIC-33G2C5	3.3 pF Tunable capacitor, 5:1 tuning ratio CSP 0.4 mm pitch
STPTIC-39G2C5	3.9 pF Tunable capacitor, 5:1 tuning ratio CSP 0.4 mm pitch
STPTIC-47G2C5	4.7 pF Tunable capacitor, 5:1 tuning ratio CSP 0.4 mm pitch
STPTIC-56G2C5	5.6 pF Tunable capacitor, 5:1 tuning ratio CSP 0.4 mm pitch
STPTIC-68G2C5	6.8 pF Tunable capacitor, 5:1 tuning ratio CSP 0.4 mm pitch
STPTIC-82G2C5	8.2 pF Tunable capacitor, 5:1 tuning ratio CSP 0.4 mm pitch
Tunable capacitors L2 series	
STPTIC-27L2C5	2.7pF Tunable capacitor, 5:1 tuning ratio CSP 0.4 mm, high linearity

BST controllers	
STHV DAC-303F6	3 outputs, 30 V , 0.5 mm pitch CSP package, SPI interface
STHV DAC-253MF3	3 outputs, 25 V, 0.4 mm pitch CSP package, MIPI RFFE interface
STHV DAC-253MTGF3	3 outputs, 25 V, 0.4 mm pitch CSP package, MIPI RFFE interface, turbo and glide modes
STHV DAC-256MTGF3	6 outputs, 25 V, 0.4 mm pitch CSP package, MIPI RFFE interface, turbo and glide modes



Interfaces

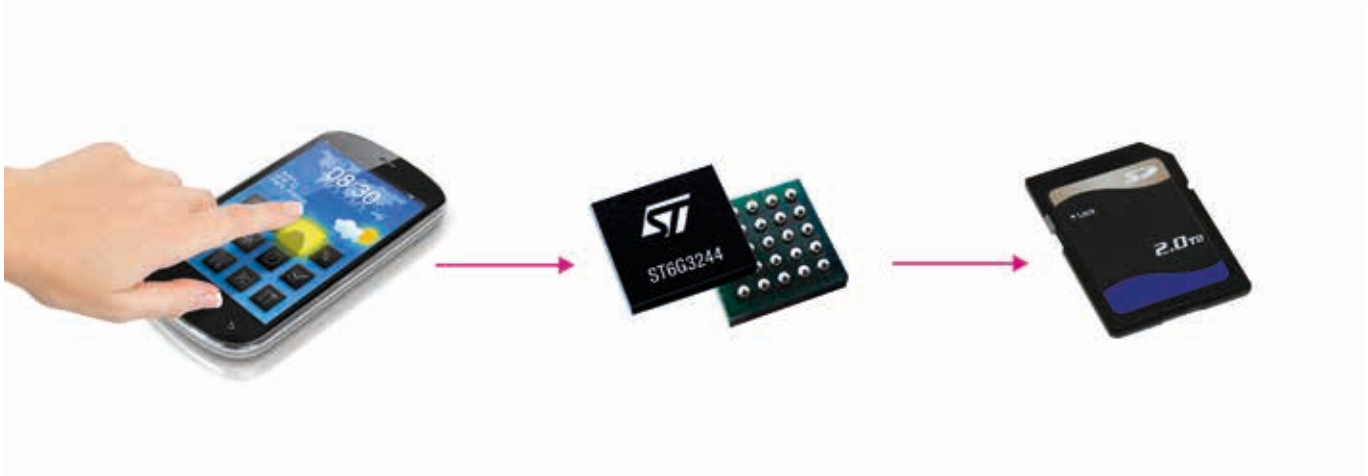

Interface secure digital (SD) cards with ST level translators.

Increase the number of I/O ports and enhance the control capability of existing platforms with ST's Xpander™ technology.

Direct audio and data signals on mobile devices with audio and high-speed switches.

Improve design and user experience with ST's smart reset devices that remove the need for dedicated reset buttons or having to remove the battery when a device freezes.

Prevent over-discharging and system start-up with low battery with supervisor devices.

LEVEL TRANSLATORS

ST's dual-supply level translators are the ideal solution for bidirectional level translation with mixed voltage systems of 1.8 V, 3.3 V and 5 V.

I/O EXPANDERS

I/O expanders with advanced features: keypad scanning, PWM and rotator general I/O expanders with 8-16 I/Os.

CAMERA INTERFACES

Deserializer for SMIA CCP1 and CCP2.
Dual mode deserializer for SMIA/CCP2 and MIPI/CSI-2.

KEY BENEFITS

- Flexibility in system design versus monolithic implementation
- Easier verification of subsystems
- Faster development time by using discrete components
- Deserializer enables use of parallel interface baseband with serial cameras

Analog switches

ANALOG SWITCHES

When multiplexing audio lines, ST's special negative power supply rail reduces the audible click/pop noise when switching between multiple sources.

HIGH-SPEED SWITCHES

For high-frequency lines such as USB and CCP (compact camera port), ST's offers a choice of switches compliant with USB 2.0 (HS) specifications and bandwidths up to 950 MHz.

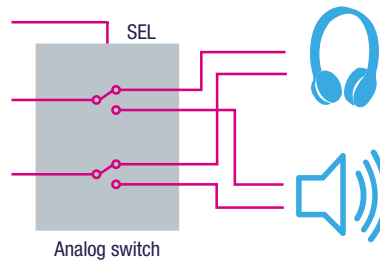

KEY BENEFITS

- Flexibility in system design versus monolithic implementation
- Easier verification of subsystems
- Faster development time by using discrete components

Real-time clock

ST's M41T62LC6F real-time clock is the perfect match for wearable devices when size, weight, and power-efficiency matters. It offers a very low frequency error at 25 °C which equates to about 5 seconds per month, an ultra-low power consumption of 350 nA in standby, and comes in an ultra-small 1.5 x 3.2 mm package with an embedded crystal oscillator.

KEY BENEFITS

- Ultra-small package with embedded crystal oscillator
- 1.5 x 3.2 x 0.8 mm
- Ultra-low power consumption (350 nA in standby)

- Timekeeping voltage down to 1 V
- Programmable alarms with wakeup functions
- ± 2 ppm accuracy by digital calibration
- Compatible with Li-Ion battery voltages

Supervisors and smart resets

38

SMART RESETS

ST's family of Smart Reset™ ICs provides dual-assert manual-reset (push-button) inputs called smart reset inputs that make it possible to reliably resolve system hang or freeze conditions.

Dual-assert manual-reset inputs require the user to assert two inputs simultaneously to initiate the system reset function.

STM6519 and STM6524 are single- and dual- push-button smart reset ICs that add flexibility and user convenience at reduced size.

SUPERVISORS

Smart voltage supervisors with on/off controls; prevents over-charging and starting system with low battery.

KEY APPLICATIONS

- Smartphones, tablets, smart watches
- Wearable / IoT devices
- Multimedia and MP3 players
- Activity trackers
- Portable navigation devices
- Any application that requires 1 or 2 delayed push buttons

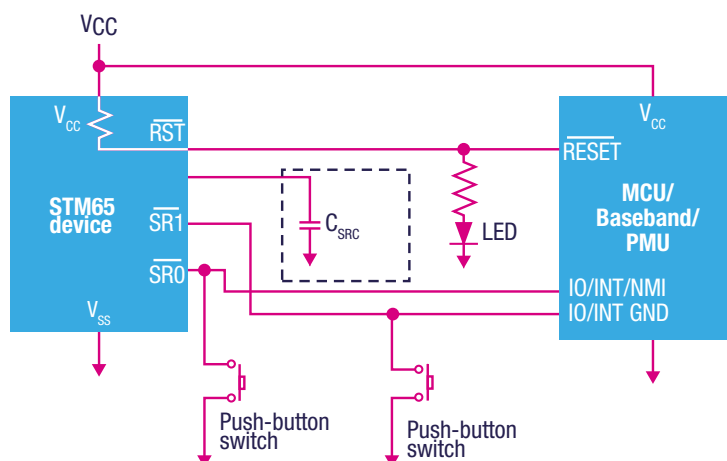

KEY BENEFITS

- Ideal for touch screen devices with non-removable batteries
- Reuses existing keys for reset, no need for dedicated reset key

FEATURED PRODUCTS

HIGH-PERFORMANCE SD CARD LEVEL TRANSLATOR

ST6G3244

The ST6G3244 is a dual-supply, low-voltage 6-bit bidirectional CMOS level translator for SD, miniSD and microSD cards. Designed for use as an interface between baseband and memory cards, it achieves high-speed operation while maintaining CMOS low power dissipation. This device is intended for two-way asynchronous communication between data buses. All inputs are equipped with protection circuits against electrostatic discharge, giving them ESD and transient excess voltage immunity.

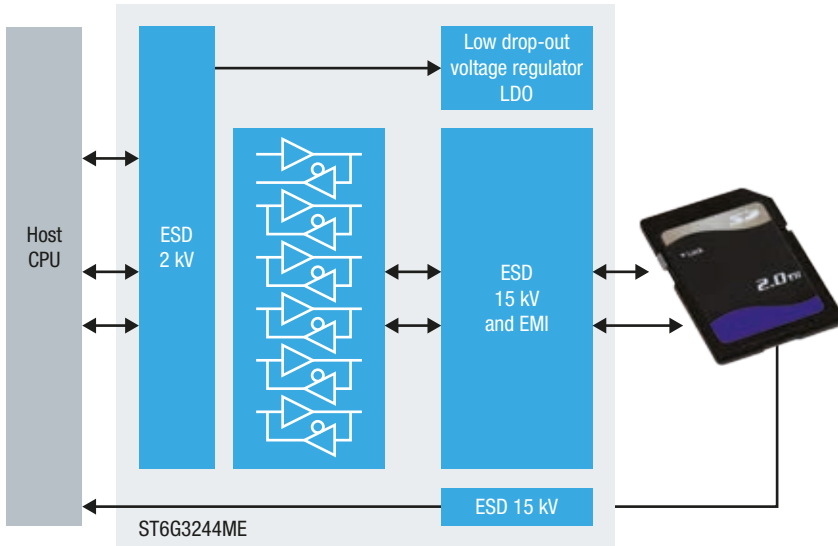

KEY FEATURES

- Supports 60 MHz clock rate
- Supports DDR mode for SD Card™
- Compliant with
 - SD Specification Part 1 Physical Layer Specification 3.00 (SDR12, SDR25, DDR50)
 - SD Specification Part 1 Physical Layer Specification 2.00
- Bidirectional with direction control pin
- EMI filtering and signal conditioning

DEVICE SUMMARY

Level translators	
ST2378E	8-bit, auto directional, OE, 15 kV ESD
ST6G3244	6-bit, SD3.0 card I/F, CSP25
I/O expanders	
STMPE1600	16-bit basic I/O expander, low power
STMPE1801	18-bit enhanced I/O expander
Analog switches	
STG5123	Single SPDT, 1 Ω, DFN6
STG3692	Quad SPDT, USB2, QFN16
STG3696	Dual SPDT, USB2, QFN10
STG4158	Single SPDT, 0.6 Ω, CSP6
STG4160	Single SPDT, 0.5 Ω, CSP8
STG3220	Dual SPDT, USB2, QFN10
STG5678	Dual SPDT, negative rail, CSP12
Smart resets	
STM6519	Single push button, DFN6
STM6524	Dual push button, DFN6
Supervisors	
STBP110	1.2 A, 170 mΩ $R_{DS(on)}$, DFN8
STBP120	2.0 A, 90 mΩ $R_{DS(on)}$, DFN10
Real-time clock	
M41T62	Ultra-low-power serial real-time clock, LCC8 package (3.2 x 1.5 mm), supply current 350 nA, supply voltage 1.3 to 4.4 V



Protection and EMI filtering

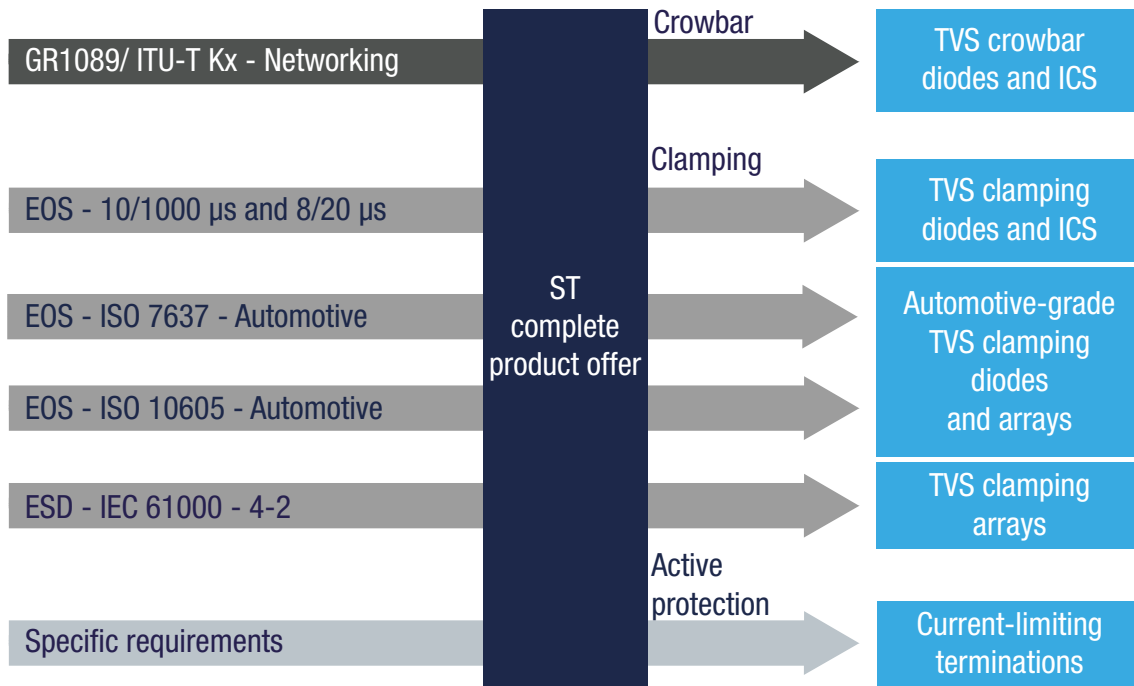

Protection devices

IPAD™ products integrate the various functions required by wireless applications, such as ESD protection diodes, EMI low-pass or common-mode filters, line terminations, and pull-up or pull-down resistors. ST's complete protection and filtering range with integrated or standalone solutions offers design flexibility while bringing space saving and high system immunity.

ESD PROTECTION

Our solutions are not only specified against the highest level of IEC 61000-4-2 for robustness, but also target the lowest clamping voltages, and lowest residual currents for the highest protection efficiency. Protective devices for clamping arrays, rail-to-rail topologies, USB ports and high-speed ports are driven by requirements for robustness, efficiency, and transparency.

EOS PROTECTION

ST proposes dataline and powerline high power-density protection, rated against IEC 61000-4-5. These EOS 8/20 μ s protection devices are available in a large choice of packages, from 0402 to SMC, bringing flexibility to designers and reliability to the application.

KEY FEATURES

- Robust ESD protection at system level including high-speed serial interfaces

EMI and common mode filtering



AUDIO AND VIDEO IPAD

ST has developed a complete range of EMI filter and CMF (ECMF™) components dedicated to audio and video interfaces such as microphones, headsets, speakers, earphones, and analog TV out or HDMI. These devices provide efficient filtering of wireless frequencies above 800 MHz as well as superior ESD protection with extremely low clamping voltages.

DISPLAYS AND CAMERAS

ST's ECMF™ series offers silicon common-mode filters combined with high-efficiency ESD protection. Now available in micro-QFN and CSP packages, this series offers ultra-compact form factors and covers high-speed serial interface standards including MIPI. The ECMF devices are designed to avoid RF antenna desense and to protect ICs against destructive electrostatic discharges (ESD). They are particularly well suited for applications frequently subjected to RF link-loss, due to the high-speed differential links – USB or MIPI – combined with antenna RF, Bluetooth, or Wi-Fi connectivity.

MEMORY AND SIM CARD IPAD

A complete range of IPAD™ components dedicated to memory-card interfaces such as used for microSD, T-Flash or SIM cards. These devices provide efficient filtering of wireless frequencies above 800 MHz as well as superior ESD protection with extremely low clamping voltage. Available in CSP or micro-QFN packages, these filters cover new standards such as SDA3.0 (SDR 104).

STANDARD MULTILINE BUS IPAD

A complete range of IPAD™ components designed for bottom connectors and general-purpose uses for mobile phones. These devices provide efficient filtering of wireless frequencies above 800 MHz as well as superior ESD protection with extremely low clamping voltages. Available in CSP or micro-QFN packages, RC or LC topologies, low- or high- line capacitance, these multiline filters immunize both digital and analog lines.

USB IPAD

These devices combine EMI low-pass or common-mode filters, ESD protection, and pull-up or pull-down resistors to support USB 2.0 and USB 3.1 specifications.

KEY FEATURES

- Single chip interface integrating resistors, capacitors, inductors, and ESD components
- PCB space saving up to 80% of board area compared to equivalent discrete solutions

FEATURED PRODUCTS

USB FLOW-THRU ESD PROTECTION

HSP051-4N10

ST's new HSP051-4N10 alleviates the increasing sensitivity to ESD events from the user through the external connector of high-speed differential-line transceivers such as USB 3.1 (10 Gbit/s) or HDMI 2.0 4K (5.94 Gbit/s) interfaces. This ESD array is compatible with USB Type C connectors and protects ICs from contact discharges up to 8 kV as defined by IEC 61000-4-2 Level 4, with very low dynamic resistance (0.48 Ω). Its 1.9 mm² and 4-channel flow-through μ QFN-10L package is only 0.32 mm thick with a 0.4 mm pitch, and minimizes impedance mismatch. With only 0.35 pF line capacitance, signal integrity is preserved, providing a 10 GHz bandwidth.

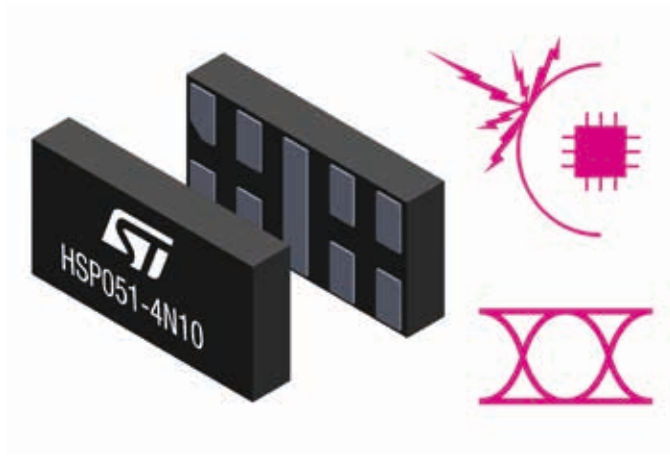

KEY FEATURES

- Flow-through routing to keep signal integrity
- Ultralarge bandwidth: 10 GHz
- Ultralow capacitance:
 - 0.2 pF (I/O to I/O)
 - 0.35 pF (I/O to GND)
- Very low dynamic resistance: 0.48 Ω
- Low leakage current: 100 nA at 25 $^{\circ}$ C

42

COMMON-MODE FILTERS WITH INTEGRATED ESD PROTECTION

ECMF04-4HSWM10

Smartphones are exposed to antenna input power sensitivity decrease due to common-mode noise radiating in Rx bands coming from USB data transmissions. This may lead to RF link loss and consequently to user frustration. The latest common-mode filter in ST's ECMF™ series – the ECMF04-4HSWM10 – features deep attenuation of common-mode noise at GSM, W-CDMA, LTE, GPS, BT and Wi-Fi (2.4 GHz and 5 GHz) frequencies, combined with a robust +8 kV contact discharge ESD protection. Housed in a tiny μ QFN package, it is compatible with the new USB Type C connector, and saves up to 30% of the PCB area compared to an equivalent discrete solution.



KEY FEATURES

- Ultra wide differential bandwidth: up to 7 GHz
- High common-mode attenuation (Scc21): from 800 MHz to 5 GHz
- Compliance with IEC 61000-4-2 discharge with low clamping voltage
- Low DC resistance
- 60% PCB space saving versus discrete solution

DEVICE SUMMARY

Display, camera and keypad IPAD	
ECMF04-4HSM10	2-pair common-mode filter with integrated ESD protection in micro-QFN
ECMF06-6HSM16	3-pair common-mode filter with integrated ESD protection in micro-QFN
EMIF0x-1502Mx	4/6/8-line low-capacitance EMI filter and ESD protection in micro-QFN
ECMF04-4AMX12	2-pair common-mode filter with integrated ESD protection in micro-QFN
ECMF06-6AM16	3-pair common-mode filter with integrated ESD protection in micro-QFN
Audio jack IPAD	
EMIF04-EAR02M8	2-line EMI filter for earphones + 2-line EMI filter for microphones with integrated ESD protection in micro-QFN
EMIF02-SPK03F2	2-line EMI filter and ESD protection for speakers with 0.07 Ω typ. DC line
EMIF02-SPK02F2	2-line EMI filter and ESD protection for speakers with 0.35 Ω typ. DC line resistance
ESDA5-1BF4	Single line bidirectional ESD protection in 0201 package with < 10 V remaining voltage
Memory and SIM card IPAD	
EMIF03-SIM03F3	3-line EMI filter and ESD protection for SIM card interfaces in chip scale package 0.4 mm
EMIF03-SIM05F3	3-line EMI filter and ESD protection for SIM card interfaces + NFC in chip scale package
EMIF06-MSD02N16	6-line EMI filter and ESD protection for mini and microSD cards, SD3.0 in micro-QFN
EMIF06-HSD04F3	6-line EMI filter and ESD protection for mini and microSD cards, SD3.0 UHS-1 in chip scale package
USB 2.0 High Speed	
ECMF02-2BF3	Single-pair common-mode filter with integrated ESD protection in chip scale package 0.4 mm
ECMF02-2AMX6	Single-pair common-mode filter with integrated ESD protection in micro-QFN
ECMF02-4CMX8	Single-pair common-mode filter + ID pin + V_{BUS} with integrated ESD protection in micro-QFN
ECM02-0730V12M12	Single-pair ESD + common-mode filter + ID pin & Vbus 9 V ESD protection
USBULC6-3F3	3-line ESD protection with 8.5 GHz bandwidth in chip scale package
Standard multiline bus IPAD	
EMIF01-1003M3	1-line EMI filter with integrated ESD protection in micro-QFN
EMIF02-1003M16	2-line EMI filter with integrated ESD protection in micro-QFN
EMIF04-1005M8	4-line EMI filter with integrated ESD protection in micro-QFN
EMIF06-1005M/N12	6-line EMI filter with integrated ESD protection in micro-QFN
EMIF08-1005M/T16	8-line EMI filter with integrated ESD protection in micro-QFN
Super speed USB and HDMI 2.0	
HSP051-4M5 ⁽¹⁾	4-line ultra-large bandwidth (12 GHz) ESD protection in 1.3 x 0.8 mm pitch μ QFN flow-thru package
ESDAXLC6-1BU2	Single-line ESD protection for high-speed lines in 0201 package
HSP051-4N10	4-line ultra-large bandwidth ESD protection in 1.9 x 1.0 mm flow-thru package
ESDARF02-1BU2CK	Single-line extra-low-capacitance (20 GHz bandwidth) bidirectional ESD protection in 0201 package
Clamping array	
ESDALC6V1-5T6	5-line 1 x 1 mm ESD protection in micro-QFN
ESDALC6V1M3	Dual low-capacitance for ESD protection in micro-QFN
ESDAVLC5-1BF4	Single-line very-low-capacitance (7 pF max) bidirectional ESD protection in 0201 package
ESDAULC5-1BF4	Single-line ultra-low-capacitance (3 pF max) bidirectional ESD protection in 0201 package
EOS protection for USB power delivery (pin Vbus)	
SMM4F24A	20 V / 60 A (8/20 μ s) EOS and ESD protection
SMM4F13A	13 V / 85 A (8/20 μ s) EOS and ESD protection
ESDA7P60-1U1M	5 V / 60 A (8/20 μ s) EOS and ESD protection
ESDA13P70-1U1M ⁽¹⁾	9 V / 70 A (8/20 μ s) EOS and ESD protection

Note: 1. Under development - target datasheet and samples available upon request.



Power management



ST's power management ICs especially designed for use in mobile devices provide high efficiency and low standby power consumption with high power density for a wide range of functions including solutions for battery charging and monitoring, LED drivers for backlights and camera flashes, power supplies for OLEDs as well as switching and linear voltage regulators and are available in a choice of miniature packages for reduced footprint and height.

44

LDO regulators

Our range of LDOs features an optimal combination of low dropout voltage, low quiescent current, fast transient response, low noise and high power supply rejection even with no external capacitor. With output voltages ranging from 0.8 to 5 V and current from 50 to 300 mA, they are available in miniature packages making them ideal for use in mobile devices.

FEATURED PRODUCTS

LDBL20

200 mA - low quiescent LDO in ultra-miniature bump-less CSP
Small is good in mobile devices. Smallest is best: LDBL20 is world's smallest 200 mA LDO with its amazing 0.47x0.47 mm bump-less chip-scale package (CSP). In addition to its low quiescent current, shutdown feature, a large selection of output voltages and tiny size makes it a great help for designers.

KEY FEATURES

- Large selection of output voltages and currents
- Miniature DFN, SOT and chip-scale packages
- Very low quiescent current
- Ultra-low noise and high PSRR for RF circuit power supplies
- Requires no bypass capacitor

KEY FEATURES

- 200 mV typical dropout at 200 mA
- Low quiescent current
 - 20 μ A @ no load
 - 100 μ A @ 200 mA
 - 0.03 μ A in OFF mode
- Output voltage range from 0.8 to 5 V in 50 mV steps
- Bump-less CSP (0.49 x 0.49 mm)

DC-DC Converters

In mobile, battery-operated applications high efficiency and small size are paramount and that's what drove us in the development of our dedicated DC-DC converters. Available in step-down, step-up and buck-boost topologies, they feature high switching frequencies and low quiescent current and are hosted in miniature DFN or chip-scale packages.

FEATURED PRODUCTS

ST1S15, 500 mA step-down converter

The ST1S15 is a high-efficiency miniaturized step-down converter with 500 mA output current from an input voltage ranging from 2.3 to 5.5 V. Thanks to its capability to run at a 6 MHz switching frequency, the ST1S15 can use the smallest nominal values for the inductor (470 nH) and for the output capacitor (4.7 μ F) still providing very good load and line transients. Hosted in a small 6-bump chip-scale package, it provides invaluable help in reducing size and efficiency.



KEY FEATURES

- Miniature chip-scale packages
- Very low quiescent current
- High switching frequency for reduced losses and size
- Step-down, step-up and buck-boost topologies supported

KEY FEATURES

- 500 mA output with 85% efficiency
- 45 μ A quiescent current
- PFM or PWM operation for highest efficiency over whole load range
- Ultra-fast load and line transient
- Flip-chip package (1.19 x 0.93 mm)

Battery management

ST's range of battery management solutions includes linear and single- or dual-input switching chargers, a chipset for wireless charging for implementations compliant with industry standards, standalone gas-gauge for accurate battery state-of-charge reporting and PMIC with charger, gas gauge and LDOs. Many solutions for a single problem: keeping your battery in great shape for a prolonged, useful life.

FEATURED PRODUCTS

STWBC and STWLC03, RX and TX chipset for wireless chargers

The STWBC and STWLC03 form a complete transmitter and receiver chip-set for wireless chargers. With their optimized set of analog peripherals – such as ADCs and timers for PWM generation - their efficient CPU and the on-chip of non-volatile memory, they require just a handful of external components to implement a complete wireless chargers that can be easily made to comply with PMA and Qi industry standards.

KEY FEATURES

- Extensive integration for reduced external component count and size
- Miniature QFN, DFN and chip-scale packages
- Very low quiescent current
- High efficiency

KEY FEATURES

- Qi and PMA standards supported
- Extensive set of on-chip peripherals
- Integrated synchronous rectification DC-DC converter (STWLC03)
- Native support for half- and full-bridge topologies (STWBC)
- On-chip NVM memory

STBCFG01, battery charger with OTG boost and voltage mode fuel gauge for single-cell Li+ batteries

The STBCFG01 is a highly integrated power management IC with all the necessary functions to charge single cell Li-Ion batteries, monitor the battery charge and generate 5 V to supply USB OTG bus powered devices. High switching frequency and low quiescent current ensure high efficiency in the charger section while the voltage mode fuel gauge provides accurate estimation of the state of requiring no external sensing resistor to keep external part count low and size small also thanks to a small 2.3 x 2.2 mm CSP.



KEY FEATURES

- High efficiency switching battery charger
- 1.2 A max. charging current and 20 V max tolerant input with OVP
- 500 mA supply for USB OTG
- High accuracy voltage mode fuel gauge
- Small-footprint flip-chip package, 25 bumps (2.3 x 2.2 mm)

Battery monitoring

46

Gas gauge IC for handheld applications

The STC3115 and STC3117 include the hardware functions required to implement a low-cost gas gauge for battery monitoring. The devices use current sensing, Coulomb counting and accurate measurements of the battery voltage to estimate the state-of-charge (SOC) of the battery. An internal temperature sensor simplifies implementation of temperature compensation.

An alarm output signals a low SOC condition and can also indicate low battery voltage. The alarm threshold levels are programmable.

The STC3115 and STC3117 offer advanced features to ensure high-performance gas gauge functions in all application conditions.

The devices are available in a 10-bump CSP package (1.4 x 2.0 mm) and in a 9-bump CSP package (1.5 x 1.6 mm) perfect for ultra-mobile, small form-factor applications, and the STC3115 also comes in a 10-lead DFN package (2.0 x 3.0 mm) that is easier to solder and has greater PCB bending tolerance.



LED drivers and display supplies

The many LEDs used in modern mobile terminals require driving solutions that are optimized for the different uses of the light source. ST offers a large portfolio of energy-efficient display supplies and drivers designed for boost topologies used by high-brightness LED solutions with multiple dimming controls for backlight LEDs as well as for high-efficiency, synchronous buck-boost topologies designed for driving a single or multiple strings of white LED for electronic flash units. We offer also highly-integrated optimized low-noise DC-DC converters for passive (PMOLED) and active (AMOLED) OLEDs with negative voltage capability.

KEY FEATURES

- Extensive integration for reduced external component count and size
- Very low quiescent current
- High efficiency, low noise
- Miniature QFN, DFN and chip-scale packages

FEATURED PRODUCTS

STOD32W, triple DC-DC converter for AMOLED display supplies.

Integrating a main step-up converter, an inverting DC-DC converter, and an auxiliary step-up converter – with programmable output voltage - the STOD32W provides an optimized solution for AMOLED display panel supplies as well as an optimized TDMA noise filter to minimize flickering. The STOD32W comes in an optimized flip-chip package to help reduce the size of the final application.



KEY FEATURES

- 100 mA/4.6 V main step-up converter
- Negative step-up with up to -4.6 V programmable output voltage
- 55 mA auxiliary step-up with up to 7.6 V programmable output voltage
- High efficiency, low noise
- Miniature flip-chip package (1.6 x 1.7 mm)

DEVICE SUMMARY

LDO regulators	
LDBL20	200 mA, low-quiescent current and High PSRR in 0.49 x 0.49 mm bump-less csp
LD39130S	300 mA, ultra-low-quiescent current with automatic green-mode
LD39115J	150 mA, ultra-low-drop, low IQ, low noise
LD39050	500 mA, ultra-low-drop and power good
LD39030SJ	300 mA, ultra-low-drop, soft start
LD39020	200 mA, low quiescent current and High PSRR
LD59015	150 mA, very-low-noise, high PSSR
LDCL015	150 mA, capacitor less, ultra low drop
LDLN015	150 mA, ultra-low-noise, high PSRR
LDK120	200 mA low quiescent current and low noise
LDK130	300 mA low quiescent current and low noise
STLQ50	50 mA, ultra-low IQ, very low drop
STLQ015	150 mA, ultra-low IQ, very low drop
DC-DC converters	
ST1S15	500 mA, 6 MHz, PFM/PWM step-down converter
STBB2	800 mA 2.5 MHz, high-efficiency dual mode buck-boost DC-DC converter
STBB3J	2 A, 2 MHz, high-efficiency dual mode buck-boost DC-DC converter
STBB3JCC	2 A, high-efficiency single inductor buck-boost DC-DC converter and high brightness white LED driver
Battery management	
STBCFG01	Switch-mode single cell Li+ battery charger with OTG boost, voltage mode fuel gauge and LDO
STBC02 ⁽¹⁾	450 mA linear battery charger with switch matrix and LDO
STBC03 ⁽¹⁾	650 mA linear battery charger with switch matrix and LDO
L6924D	1 A wall/USB charger for Li-ion and Li-Po
L6924U	Single cell Li-Ion battery charger IC for USB port and AC adapter
STNS01	Li-Ion Linear Battery Charger with LDO
STWBC	Digital controller for wireless battery charger transmitters Qi 1.1.2 A11 certified, PMA compatible
STWLC03 ⁽¹⁾	Dual mode Qi/ PMA wireless power receiver
LED and Display supply	
STOD32W	100 mA triple DC-DC converter for AMOLED displays
STOD1317B	170 mA 13 V, high-efficiency boost converter with LDO for AMOLED displays
STP4CMP	Low-voltage 4-channel constant current LED driver with charge pump for backlight
STCF04	High-power white LED SuperCap driver with I ² C interface

Note: 1. Under Development

life.augmented



© STMicroelectronics - December 2015 - Printed in United Kingdom - All rights reserved
The STMicroelectronics corporate logo is a registered trademark of the STMicroelectronics group of companies
All other names are the property of their respective owners

