

zoomingADC

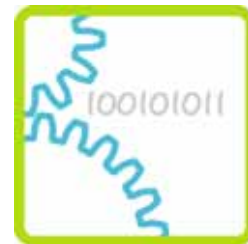

XE8000EV110 Evaluation board for XE88LC02MIO35 User's Guide V1.0

For further information please contact
XEMICS SA
E-mail: info@xemics.com
Web: <http://www.xemics.com/>

TABLE OF CONTENTS

XE8000EV110 Evaluation board for XE88LC02MIO35	1
1 General Introduction	3
1.1 1.1 Introduction.....	3
1.2 1.2 Highlights.....	3
1.3 1.3 About this Guide.....	3
1.4 1.4 Documentation Updates.....	3
1.5 1.5 Recommended Reading	3
1.6 1.6 Troubleshooting.....	3
1.7 1.7 The XEMICS Internet Web Site	3
1.8 1.8 Customer Support	3
2 Overview and installation.....	4
2.1 Introduction.....	4
2.2 Highlights.....	4
2.3 What is XE8000EV110.....	4
2.4 XE8000EV110 components	4
2.5 How XE8000EV110 helps you	4
2.6 Installing XE8000EV110 hardware	5
2.6.1 Placing the chip on the ZIF socket.....	5
2.6.2 Using an external power supply	5
2.6.3 Using a button type battery	5
2.6.4 Using the ProStart II as power supply and programmer.....	5
2.6.5 Using an external clock source	5
2.6.6 Measuring the circuit consumption	5
2.6.7 How to use the on-board EEPROM	5
3 Electrical specifications and hardware description.....	6
3.1 Introduction.....	6
3.2 Hardware layout	6
3.3 LCD Board.....	7
3.4 Hardware layout of the LCD board.....	7
3.5 LCD connector	7
3.6 LCD specifications.....	8
3.7 LCD display mechanical specifications	8
3.8 Segments mapping	9
4 Troubleshooting.....	10
4.1 Introduction.....	10
4.2 Highlights.....	10
4.3 XE8000EV110 functionality	10
4.4 XE8000EV110 hardware.....	10
5 Schematics	11

TABLE OF FIGURES

Figure 1 Position of the chip in the ZIF socket	5
Figure 2 Board elements	6
Figure 3 detailed view of the header	6
Figure 4 LCD board hardware layout	7
Figure 5 EV110 LCD connector (top view)	7
Figure 6 EV110 LCD connector (side view)	7
Figure 7 LCD display mechanical data	8
Figure 8 Segments naming convention	9
Figure 9 XE8000EV110 Schematic	11

TABLE OF TABLES

Table 1 LCD display vs XE8000 registers mapping	9
Table 2 Manufacturers LCD segment mapping.....	9

1 GENERAL INTRODUCTION

1.1 Introduction

This first chapter contains general information that will be useful to know before using the XE8000EV110

1.2 Highlights

The information you will gain from this chapter:

- About this Guide
- Recommended Reading
- Troubleshooting
- The XEMICS Internet Web Site
- Customer Support

1.3 About this Guide

This document describes how to use The XE8000EV110 as an evaluation board to develop and debug programs on the XE88LC02 microcontroller in TQFP100 package.

The manual Layout is as follows:

- Chapter 2 : Overview and Installation
- Chapter 3 : Electrical specifications and hardware description
- Chapter 4 : Troubleshooting
- Chapter 5 : Schematics

1.4 Documentation Updates

All documentation evolves and this User's Guide is no exception. Since XE8000EV110 and other XEMICS tools are constantly evolving to meet customer needs, some tool descriptions may differ from those in this document. Please refer to our web site at www.xemics.com to obtain the latest documentation available.

1.5 Recommended Reading

This user's guide describes how to use The XE8000EV110. Other useful documents are listed below:

- Datasheet XE88LC02.
- ProStart II (XE8000MP) user guide
- XEMICS Application notes (AN8000.xx).

These can be found on our web site www.xemics.com/products/XE8000

1.6 Troubleshooting

See Chapter 4 for information on common problems.

1.7 The XEMICS Internet Web Site

XEMICS provides on line support on the XEMICS World Wide Web site. The web site is used by XEMICS as a means to make files and information easily available to customers. It is at <http://www.xemics.com>

1.8 Customer Support

Customers should call their distributor, representative or field application engineer for support. Users of XEMICS products can receive assistance through several channels:

- Distributors or Representative, Local Sales Office
- Field Application Engineer (FAE)
- Third party for source code

2 OVERVIEW AND INSTALLATION

2.1 Introduction

This chapter gives you an overview of the XE8000EV110 evaluation board and then explains how to install the system hardware.

2.2 Highlights

The items discussed in this chapter include:

- What is XE8000EV110
- XE8000EV110 components
- How XE8000EV110 helps you
- Installing XE8000EV110 hardware

2.3 What is the XE8000EV110

The XE8000EV110 is the evaluation board for XE88LC02 microcontroller packaged in the TQFP100. This board is designed to be interfaced with the XE8000MP board also. Note that the combination of a XE8000MP and any XE8000EVXXX constitutes the ProStart II system. The XE8000EV110 allows the user to access to every pin of the chip, and provides external actuators and indicators such as LEDs and buttons.

2.4 XE8000EV110 components

The XE8000EV110 is delivered separately, with 3 XE88LC02 samples. However you need to have the XE8000MP to program these samples. Since one XE8000MP is compatible with the whole XE8000 family, this allows you to have multiple XE8000EVXXX without having to buy another XE8000MP.

XE8000EV110 packages contents:

- 1 XE8000EV110
- 1 Box
- 3 Samples

2.5 How the XE8000EV110 helps you

XE8000EV110 allows you to:

- Create an action on an input port with buttons (note that jumpers can disable this feature).
- Reset the circuit.
- See an action on an output port with LED (note that jumpers can disable this feature).
- Store data in an on board SPI EEPROM.
- Interface a RS232 line driver (with the help of the XE8000MP) to the UART peripheral.
- Use an on board 32kHz watch Xtal, or an external clock source.
- Measure the current consumption of the circuit.
- Power the board with three different sources :
 - An external power supply.
 - A button type battery.
 - The ProStart II board.
- Create a quick hardware application on an on-board engineering zone.

2.6 Installing XE8000EV110 hardware

2.6.1 Placing the chip on the ZIF socket

The XE88LC02 must be placed with the pin 1 marker aligned with the pin 1 marker of the board. See picture below:

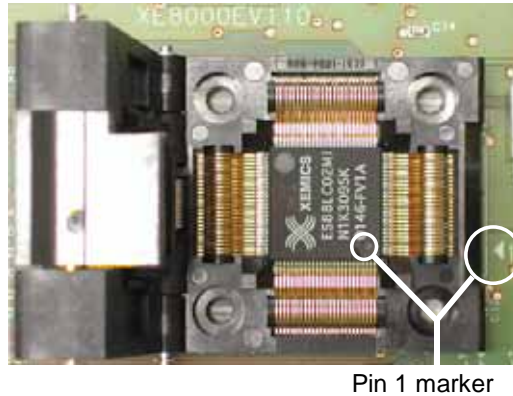

Figure 1 Position of the chip in the ZIF socket

2.6.2 Using an external power supply

To use an external power supply, the user must connect the pins labelled “+” and “-” (see Figure 2) on the header named “EXT POWER” near the battery carrier with regulated 1.2 to 5.5 Volts power supply. The switch must be in the “on” position.

Warning this power source is not protected by a fuse! The user can prevent destroying the board/chip by limiting the current of the power supply source.

2.6.3 Using a button type battery

To power the application with a battery, you may place a button battery of the type cr1620 on the carrier (+ on the top, diameter 16mm height 2.0mm). Since the carrier is flexible, the height can vary a little bit.

Warning this power source is not protected by a fuse!

2.6.4 Using the ProStart II as power supply and programmer

Please refer to ProStart II user guide to use the XE8000EV110 with the ProStart II as a power supply or a programmer.

Note : When the ProStart II (XE8000MP) is connected, all the other supply sources are bypassed, the default supply of the ProStart II (XE8000MP) is 3.0 Volts and the programming voltage is 5.0 Volts.

2.6.5 Using an external clock source

To use an external clock source, the user must disconnect the on onboard xtal by removing the br1 jumper, and place it's own source on the pin XIN on the header. (see Figure 3)

2.6.6 Measuring the circuit consumption

To measure the consumption of the XE88LC02, the user must remove the jumper named br_consumption and place an amperemeter between these two points.

2.6.7 How to use the on-board EEPROM

To use the on board EEPROM, place the jumpers br4 to br7, and for the software please check on our web site for the technical note TN8000.14 on <http://www.xemics.com/internet/support/download>

3 ELECTRICAL SPECIFICATIONS AND HARDWARE DESCRIPTION

3.1 Introduction

This chapter gives you a view of the main characteristics of the XE8000EV110 hardware.

3.2 Hardware layout

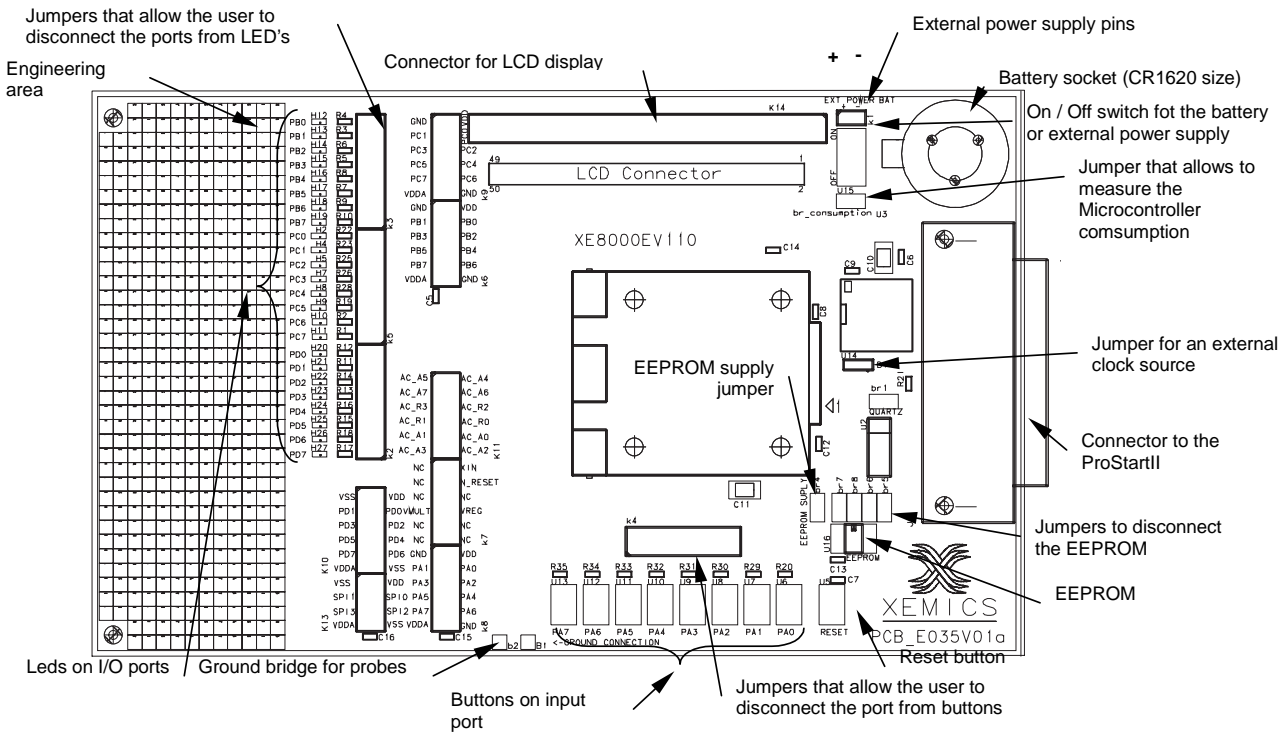

Figure 2 Board elements

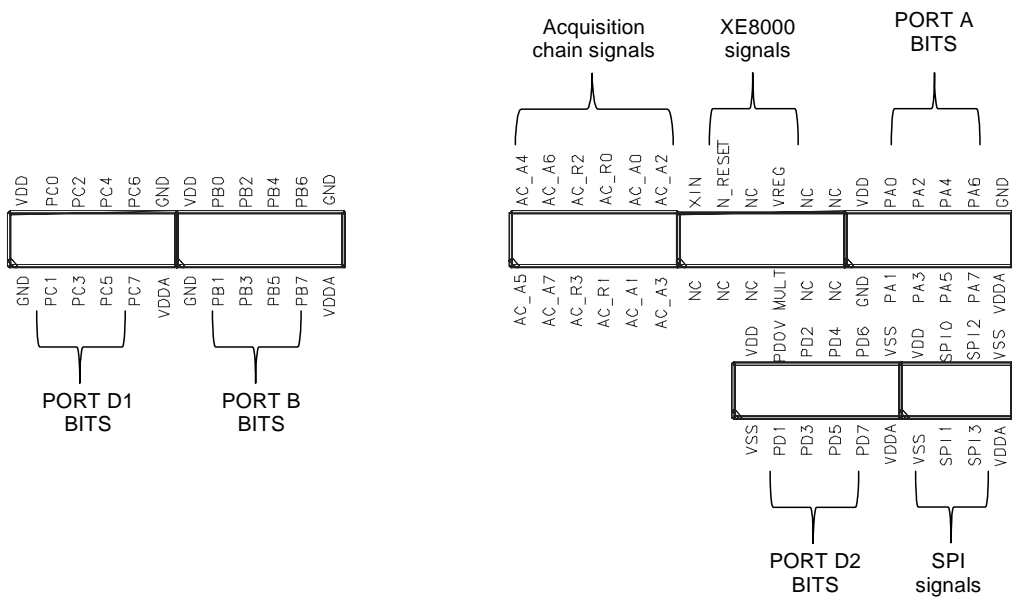

Figure 3 Detailed view of the header

3.3 LCD Board

XEMICS provides a LCD board with each EV110 in order to quickly set up an application using the LCD driver peripheral.

3.4 Hardware layout of the LCD board

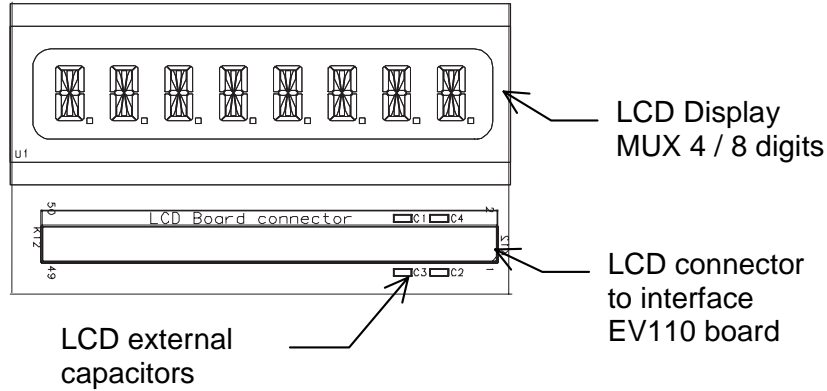

Figure 4 LCD board hardware layout

3.5 LCD connector

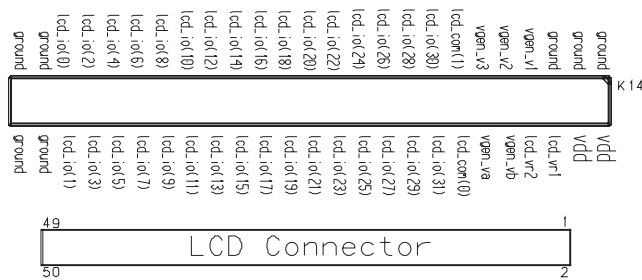

Figure 5 EV110 LCD connector (top view)



Figure 6 EV110 LCD connector (side view)

3.8 Segments mapping

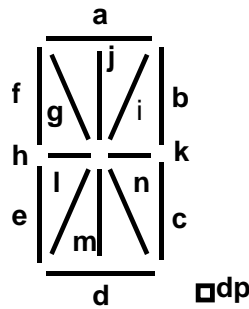

Figure 8 Segments naming convention

	LC02 registers	bit7	bit6	bit5	bit4	bit3	bit2	bit1	bit0
Digit 1	RegLcdData0	1d	1e	1f		1dp	1c	1b	1a
	RegLcdData1	1n	1k	1i	1j	1m	1l	1h	1g
Digit 2	RegLcdData2	2d	2e	2f		2dp	2c	2b	2a
	RegLcdData3	2n	2k	2i	2j	2m	2l	2h	2g
Digit 3	RegLcdData4	3d	3e	3f		3dp	3c	3b	3a
	RegLcdData5	3n	3k	3i	3j	3m	3l	3h	3g
Digit 4	RegLcdData6	4d	4e	4f		4dp	4c	4b	4a
	RegLcdData7	4n	4k	4i	4j	4m	4l	4h	4g
Digit 5	RegLcdData8	5d	5e	5f		5dp	5c	5b	5a
	RegLcdData9	5n	5k	5i	5j	5m	5l	5h	5g
Digit 6	RegLcdData10	6d	6e	6f		6dp	6c	6b	6a
	RegLcdData11	6n	6k	6i	6j	6m	6l	6h	6g
Digit 7	RegLcdData12	7d	7e	7f		7dp	7c	7b	7a
	RegLcdData13	7n	7k	7i	7j	7m	7l	7h	7g
Digit 8	RegLcdData14	8d	8e	8f		8dp	8c	8b	8a
	RegLcdData15								

Table 1 LCD display vs XE8000 registers mapping

Pin No.	Segment	Pin No.	Segment	Pin No.	Segment
1	, , , COM 4	13	3I, 3J, 3K 3N	25	3H, 3G, 3L, 3M
2	, 8F, 8E, 8D	14	, 2F, 2E, 2D	26	4A, 4B, 4C, 4DP
3	8I, 8J, 8K, 8N	15	2I, 2J, 2K, 2N	27	4H, 4G, 4L, 4M
4	, 7F, 7E, 7D	16	, 1F, 1E, 1D	28	5A, 5B, 5C, 5DP
5	7I, 7J, 7K, 7N	17	1I, 1J, 1K, 1N	29	5H, 5G, 5L, 5M
6	, 6F, 6E, 6D	18	, , COM 3 ,	30	6A, 6B, 6C, 6DP
7	6I, 6J, 6K, 6N	19	COM 1 , , ,	31	6H, 6G, 6L, 6M
8	, 5F, 5E, 5D	20	1A, 1B, 1C, 1DP	32	7A, 7B, 7C, 7DP
9	5I, 5J, 5K, 5N	21	1H, 1G, 1L, 1M	33	7H, 7G,, 7L, 7M
10	, 4F, 4E, 4D	22	2A, 2B, 2C, 2DP	34	8A, 8B, 8C, 8DP
11	4I, 4J, 4K, 4N	23	2H, 2G, 2L, 2M	35	8H, 8G, 8L, 8M
12	, 3F, 3E, 3D	24	3A, 3B, 3C, 3DP	36	, COM 2 , ,

Table 2 Manufacturers LCD segment mapping

4 TROUBLESHOOTING

4.1 Introduction

This section is intended to help the XE8000EV110 users to perform basic hardware debugging.

4.2 Highlights

This chapter contains the following points:

- XE8000EV110 functionality
- XE8000EV110 hardware

4.3 XE8000EV110 functionality

The software that should use the Xtal peripheral seems to be locked.	
Possible causes :	<ol style="list-style-type: none"> 1 The jumper br1 is removed 2 You disturb the xin and xout lines with an oscilloscope probe. 3 The Xtal is not correctly soldered on the board. 4 The Xtal is damaged.
The programme that should use the EEPROM interface or another SPI device is unable to communicate.	
Possible cause :	<ol style="list-style-type: none"> 1 The LED jumpers of the ports used are connected 2 The EEPROM jumpers (br5&6) are removed 3 The EEPROM power jumpers is removed
When using the ProStart II (XE8000MP) as power supply, the VDDA seems to be unstable.	
Possible causes :	<ol style="list-style-type: none"> 1 The PortB 7 is not used as UART RX and the RS232 line driver creates an output conflict, simply remove the RS232 cable from the ProStart II (XE8000MP) and the RS232 output will go to High Z. 2 The power consumption of your application is above 500mA

4.4 XE8000EV110 hardware

The board presents a short circuit between VDDA and GND.	
Possible causes :	<ol style="list-style-type: none"> 1 The battery carrier has been damaged and the + contact touches the - : just put a piece of paper between the two contacts 2 If you are measuring a signal on the board, be careful to not use the ground connection on the headers : There is a more accessible ground near the PA7 button.
The power supply of the battery is not present on the VDDA line.	
Possible causes :	<ol style="list-style-type: none"> 1 The power switch is in the wrong position, to use the battery the switch must be off. 2 The board is connected to a XE8000MP, in this case user power supplies are bypassed.
The LCD display doesn't display all the digits	
Possible causes :	<ol style="list-style-type: none"> 1 The connector is weak, try to move the board a little bit.

5 SCHEMATICS

XE88LC02 case QFP100 Eval board

PCB-E035V01A

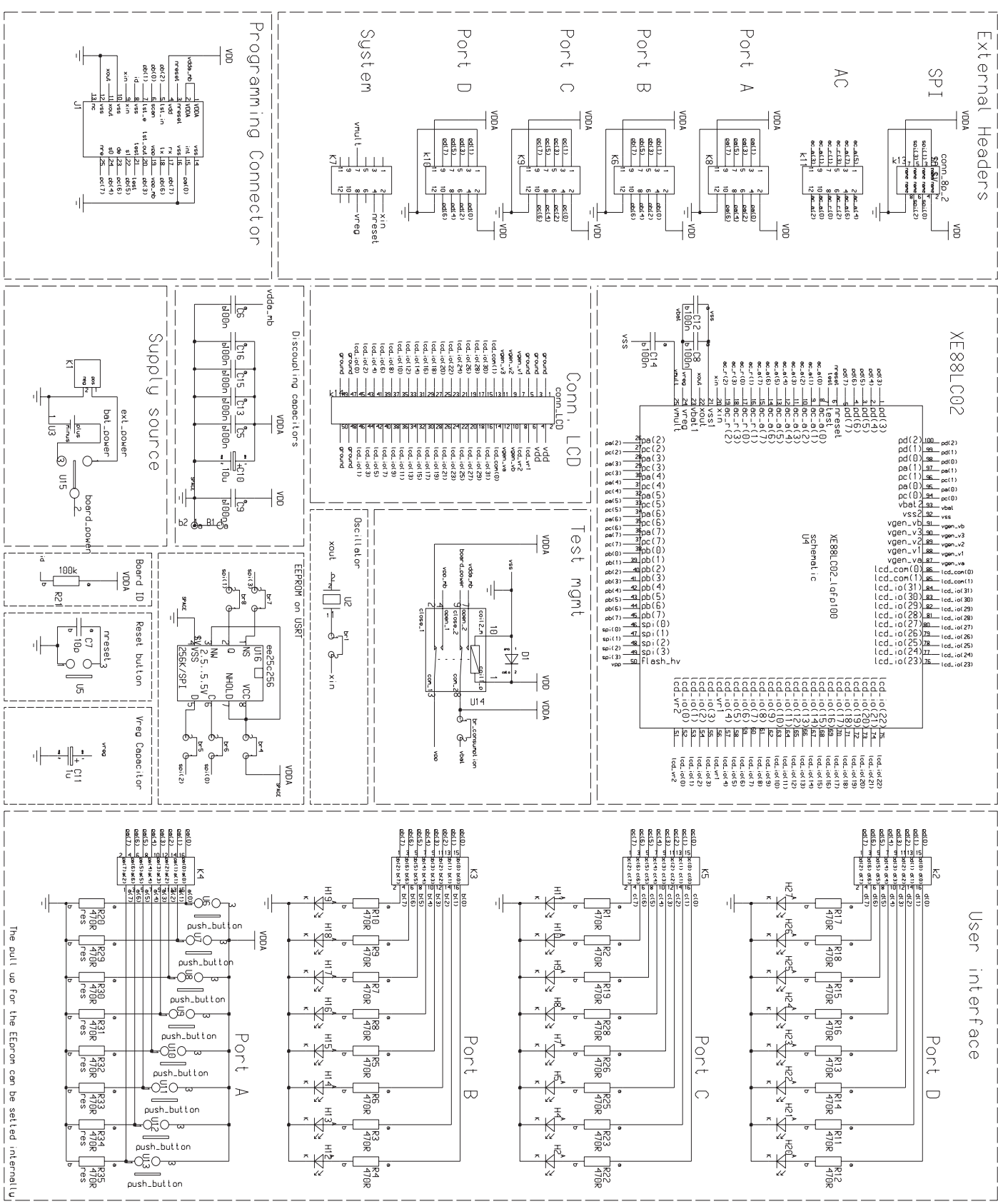

Figure 9XE8000EV110 Schematic

©XEMICS 2005

All rights reserved. Reproduction whole or in part is prohibited without the prior written consent of the copyright owner. The information presented in this document does not form part of any quotation or contract, is believed to be accurate and reliable and may be changed without notice. No liability will be accepted by the publisher for any consequence of its use. Publication thereof does not convey nor imply any license under patent- or other industrial or intellectual property rights.