

Datasheet

BTM510/511 Multimedia Module

Version 6.8 – Specific to FW v22.2.5.0

Note: For additional information on features and functionality of the BTM510/511, refer to the user guide and other documents found on the [Laird Embedded Wireless Support site's product page](#) for this module.

REVISION HISTORY

Version	Date	Notes	Approver
1.0	3/01/2012	Initial Release	Jonathan Kaye
2.0	3/30/2012	Updates and correct to firmware	Jonathan Kaye
3.0	4/13/2012	v18.1.3.0	Jonathan Kaye
4.0	10/16/2012	General reformatting edits	Jonathan Kaye
5.0	1/10/2013	Fixed Search bug.	Jonathan Kaye
6.0	3/22/2013	Fixed general formatting and hyperlink issues	Jonathan Kaye
6.1	13 Jan 2014	Update FCC and IC statements	Sue White
6.2	06 Feb 2014	Updated mechanical drawings	Jonathan Kaye
6.3	20 Feb 2014	Updated document for new firmware: v18.1.4.0/BTM51x - 08	Jonathan Kaye
6.4	15 Dec 2014	Separated document into two docs: Hardware Integration Guide and User Guide	Jonathan Kaye
6.5	22 Jan 2015	Updated Bluetooth SIG Qualification section	Jonathan Kaye
6.6	08 Jun 2015	Removed USB D+ and USB D- references	Jonathan Kaye
6.7	15 Nov 2015	Changed USB references to UART	Andrew Chen
6.8	08 Feb 2017	Fixed module height	Andrew Chen

CONTENTS

1	Overview	4
	Features	4
	Application Areas.....	4
2	Specifications.....	5
2.1	Detailed Specifications	5
2.2	Pin Definitions	6
2.3	Operating Parameters	9
2.4	Voltage Specifications	9
2.5	Audio Design Requirements	9
2.5.1	Speaker Output.....	11
3	FCC Regulatory Statements.....	11
3.1	BTM510 FCC and Industry Canada Statements.....	11
3.1.1	Considerations for OEM integration:	11
3.1.2	FCC Labelling Requirement.....	11
3.2	BTM511 FCC and Industry Canada Statements.....	12
3.2.1	Considerations for OEM Integration	12
3.2.2	FCC Labelling requirement	12
4	EU Declaration of Compliance.....	12
4.1	Declaration of Conformity – BTM510.....	12
4.1.1	Declaration	13
4.2	Declaration of Conformity – BTM511.....	13
4.2.1	Declaration	14
5	Mechanical Drawings	15
5.1	BTM510 Mechanical Drawings	15
5.4	BTM511 Mechanical Diagrams.....	17
6	Ordering Information	20
6.1	General Comments.....	20
7	Application Note.....	20
7.1	Introduction.....	20
7.2	Shipping	20
7.3	Reflow Parameters	21
8	Bluetooth SIG Qualification.....	22
9	Additional Assistance	23
10	Related Documents and Files.....	23

1 OVERVIEW

The BTM510 and BTM511 are low-power Bluetooth® modules designed for adding robust audio and voice capabilities. Based on the market-leading Cambridge Silicon Radio BC05 chipset, these modules provide exceptionally low power consumption with outstanding range. Supporting Bluetooth v3.0 specification, these modules provide the important advantage of secure simple pairing that improves security and enhances easy use.

At only 14 mm x 20 mm, the compact size of the BTM510 is ideal for battery-powered or headset form factor audio and voice devices. With a 16-bit stereo codec and microphone inputs to support both stereo and mono applications, these modules also contain a full, integrated Bluetooth-qualified stack along with SPP, HFP 1.6, HSP, AVRCP v1.5, and A2DP profiles.

The BTM510/511 modules include an embedded 32-bit, 64-MIPS DSP core within the BC05. This is integrated with the Bluetooth functionality which allows designers to add significant product enhancements including features such as echo cancellation, noise reduction, and audio enhancement using additional soft codecs. The availability of the 16MB of flash memory in the module allows complex functionality to be included. DSP routines can be licensed through a number of specialist partners. Typical applications for these modules include Bluetooth stereo headsets, VoIP phones, and wireless audio links.

To speed product development and integration, Laird Technologies has developed a comprehensive AT command interface that simplifies application development, including support for audio and headset functionality. Access to GPIO pins allows mapping for direct connection to actuator buttons on headsets. Combined with a low-cost development kit, Laird Technologies' Bluetooth® modules provide faster time to market.

Features

- Fully featured Bluetooth® multimedia module
- Bluetooth® v3.0 (FW v22.2.5.0 onwards)
- Supports mono and stereo headset applications
- Adaptive Frequency Hopping to cope with interference from other wireless devices
- 32-bit Kalimba DSP for enhanced audio applications
- Support for Secure Simple Pairing
- External or internal antenna options
- HSP, HFP, A2DP, and AVRCP audio profiles
- 16-bit stereo codec and microphone input
- Integrated audio amplifiers for driving stereo speaker
- Comprehensive AT interface for simple programming
- Bluetooth END product qualified
- Compact size
- Class 2 output – 4 dBm
- Low power operation
- Wi-Fi co-existence hardware support

Application Areas

- High-quality stereo headsets
- Mono voice headsets
- Hands-free devices
- Wireless audio cable replacement
- MP3 and music players
- Phone accessories
- VoIP products
- Cordless headsets
- Automotive

2 SPECIFICATIONS

2.1 Detailed Specifications

Table 1: Detailed specifications

Categories	Feature	Implementation
Wireless Specification	Standards Supported	Bluetooth® v3.0
	Transmit Class	Class 2
	Frequency	2.402 – 2.480 GHz
	Channels	79 channels Frequency Hopping Adaptive Frequency Hopping
	Maximum Transmit Power	+4 dBm @ antenna pad – BTM510 +4 dBm from integrated antenna – BTM511
	Minimum Transmit Power	-27 dBm @ antenna pad – BTM510 -27 dBm from integrated antenna – BTM511
	Receive Sensitivity	Better than -86 dBm
	Data Transfer Rate	Up to 300 kbps
	Range	Up to 30 meters
	Antenna Modes	External Antenna
Integrated Antenna		+0 dB multilayer ceramic – BTM511
UART Interface	Serial Interface	RS-232 bi-directional for commands and data
	Baud Rate	16550 compatible
	Bits	Configurable from 1,200 to 921,600 bps
	Parity	Non-standard baud rates supported
	Stop bits	8
	Default Serial parameters	Odd, even, none
	Levels	1 or 2
	Modem Control	9600,n,8,1
General Purpose Interface	I/O	4 general purpose I/O pins
	I2S	Stereo Audio Digital Interface Bus
	LED	2
Audio	Codec	Integrated stereo codec with -95 dB SNR for DAC
	Amplifiers	Direct drive for 16 Ω Speakers
	Microphone	Input for low noise microphone
	Sample Rates (DAC and ADC)	8, 11.025, 16, 22.05, 32 & 44.1kHz
Protocols and Firmware	Bluetooth® Stack	V3.0 compliant. Fully integrated.
	Profiles	GAP Generic Access Profile SDP Service Discovery Profile SPP Serial Port Profile HSP – Audio Gateway and Headset unit HFP v1.6 – Audio Gateway and Handsfree A2DP – Source and Sink AVRCP v1.5 – Target and Controller
	Protocols	RFCOMM AVCTP AVDTP

Categories	Feature	Implementation
Command Interface	AT Instruction set	Comprehensive control of connection and module operation, including extensions for Audio control. Direct mapping of GPIO to audio functions, e.g. Play, Volume, etc. S Registers for non-volatile storage of parameters
	DSP	Kalimba DSP Integrated in BC05 32bit, 64MIPS, 16 Mbps Flash Memory (shared) Applications Available from partners
Current Consumption	Data Transfer	Typically < 35 mA
	Stereo Music	Typically < 70 mA (including speaker drive)
	Low Power Sniff Mode	Less than 1.5 mA
	Supply Voltage	Supply 3.0 V – 3.6 V DC I/O 1.7 V – 3.6 V DC UART 1.7 V – 3.6 V DC
Coexistence / Compatibility Connections	WLAN (802.11)	2-wire and 3-wire hardware coexistence schemes supported
	External Antenna (option)	Pad for 50 Ohm antenna – BTM510
	Interface	Surface Mount Pads
Physical	Dimensions	14.0 mm x 20.0 mm x 2.9 mm - BTM510 14.0 mm x 25.0 mm x 2.9 mm - BTM511
	Weight	3 grams
	Environmental	Operating Temperature -40° C to +85° C Storage Temperature -40° C to +85° C
Approvals	Bluetooth®	Qualified as an END product
	FCC	Limited Modular Approval – BTM510 Modular Approval (Integrated Antenna – BTM511)
	MIC	(Japan) Previously TELEC
	CE and R&TTE	Meets CE and R&TTE requirements
	Miscellaneous	Lead free Warranty
Development Tools	Development Kit	Development board and software tools

2.2 Pin Definitions

Table 2: Pin definitions

Pin	Signal	Description	Voltage Specification
1	GPIO_8 / DTR	Host I/O	VIO
2	GPIO_5 / BT_STATE / BT_PRIORITY	Host I/O, BT Co-existence	VIO
3	PCM_IN	PCM Data I/P	VIO
4	PCM_OUT	PCM Data O/P	VIO
5	PCM_SYNC	PCM Sync I/P	VIO
6	PCM_CLK	PCM CLK I/P	VIO
7	LED_EXT1	Host I/O	See Note 2
8	LED_EXT0	Host I/O	See Note 2
9	GND		
10	VDD_UART	UART supply voltage	
11	VDD_IO	I/O supply voltage	

Pin	Signal	Description	Voltage Specification
12	VDD_IN	Main supply voltage	
13	GND		
14	SPI_CS	SPI bus chip select I/P	VIO
15	SPI_MISO	SPI bus serial O/P	VIO
16	SPI_CLK	SPI bus clock I/P	VIO
17	SPI_MOSI	SPI bus serial I/P	VIO
18	GPIO_3 / DSR	Host I/O	VIO
19	GPIO_4 / RI	Host I/O	VIO
20	GPIO_2 / DCD	Host I/O	VIO
21	GPIO_1 / BT_ACTIVE	Host I/O, BT Co-existence	VIO
22	GND		
23	AUDIO_GND	Audio ground	
24	SPKR_A_N	Speaker, channel A- (left)	See Audio Design Requirements
25	SPKR_A_P	Speaker, channel A+ (left)	See Audio Design Requirements
26	SPKR_B_N	Speaker, channel B- (right)	See Audio Design Requirements
27	SPKR_B_P	Speaker, channel B+ (right)	See Audio Design Requirements
28	MIC_BIAS	Microphone bias	See Audio Design Requirements
29	MIC_BP_C	Microphone, channel B+ (right)	See Audio Design Requirements
30	MIC_BN_C	Microphone, channel B- (right)	See Audio Design Requirements
31	MIC_AP_C	Microphone, channel A+ (left)	See Audio Design Requirements
32	MIC_AN_C	Microphone, channel A- (left)	See Audio Design Requirements
33	Unused		
34	ANT	Antenna connection – BTM510 only (50 ohm matched)	
35	Unused		
36	Unused		
37	Unused		
38	Unused		
39	Unused		
40	Unused		
41	Unused		
42	Unused		
43	Unused		
44	Unused		
45	Unused		
46	Unused		
47	GND		
48	UART_RTS	Request to Send O/P	VUSB
49	UART_CTS	Clear to Send I/P	VUSB
50	UART_TX	Transmit data O/P	VUSB
51	UART_RX	Receive data I/P	VUSB
52	GPIO_7 / RF_Active	Host I/O, BT Co-existence	VIO
53	GPIO_6 / WLAN_ACTIVE	Host I/O, BT Co-existence	VIO
54	Reset	Module reset I/P	See Note 1

Note:

1. Reset input is active low. Input is pulled up to VDD_IN via 22 k. Minimum reset pulse width is 5 ms.
2. LED drive pins are open drain outputs, so the external circuit to the right should be used. The voltage on the module pad should be maintained below 0.5 V in which case the RON of the FET is around 20 Ω. If this condition is met, the current flowing through the diode is as follows:

$$I_{led} = \frac{VDD - V_F}{R + 20}$$

Where VF is the forward bias voltage of the LED.

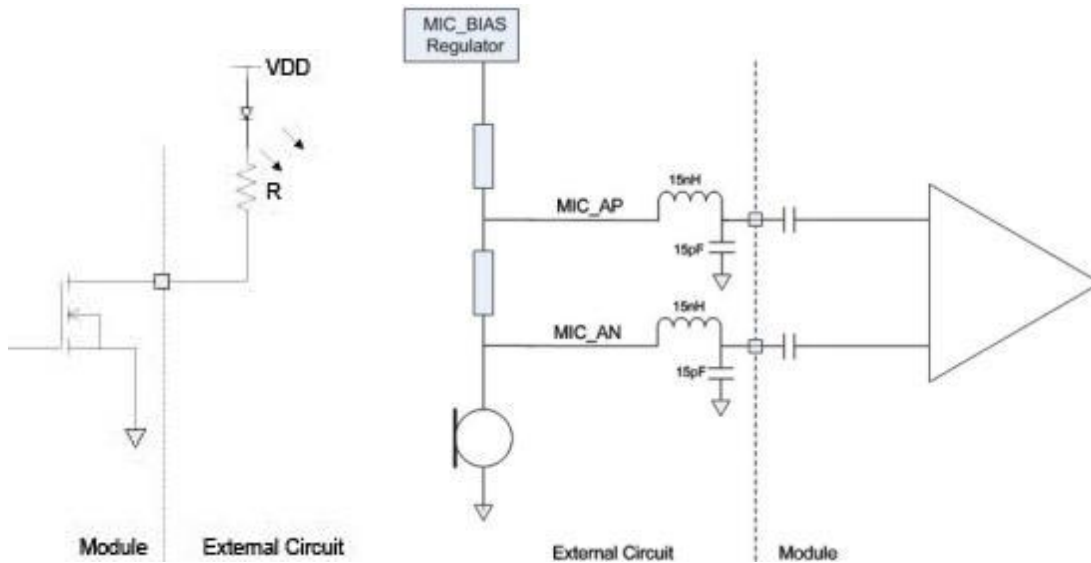

Figure 1: Microphone mode

The input impedance on the microphone inputs (in microphone mode) is typically 6kΩ. The audio input is designed for use with inputs of between 1 μA and 10 μA at 94 dB SPL. If the biasing resistors are set to 1 kΩ, this implies a microphone with sensitivity in the range -40 dBV to -60 dBV.

The low pass filter elements formed by the inductor and capacitor are necessary to eliminate RF pick up on the microphone inputs and should be placed as close to the module as possible. When operating in line input mode, the input can be connected directly to the module input pins in either single or double ended configuration as follows:

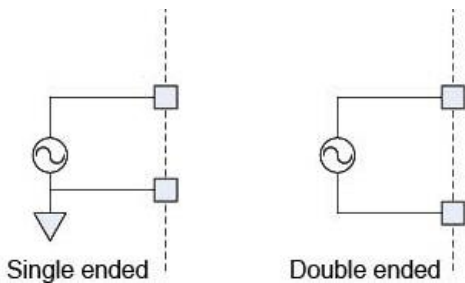

Figure 2: Line input mode

2.3 Operating Parameters

Table 3: Operating parameters

Recommended Operating Conditions		
Operating Condition	Min	Max
VDD_UART	1.7	3.6
VDD_IO	1.7	3.3
VDD_IN	3.0	3.6

2.4 Voltage Specifications

Table 4: Voltage specifications (VUART)

Logic Levels (VUART)			
Input Voltage Levels	Min	Typical	Max
V _{ih}	0.7VDD_UART		
V _{il}	-0.4		+0.8
OUTPUT VOLTAGE LEVELS			
V _{oh} (I _{out} = -4mA)	VDD_UART – 0.4		
V _{ol} (I _{out} = 4mA)	0		0.4

Table 5: Voltage specifications (VIO)

Logic Levels (VIO)			
INPUT VOLTAGE LEVELS	MIN	TYPICAL	MAX
V _{ih}	0.625 VDD_UART		VDD_IO+0.3
V _{il}	-0.3		0.25VDD_IO
Output Voltage Levels			
V _{oh} (I _{out} = -4mA)	0.75VDD_IO		VDD_IO
V _{ol} (I _{out} = 4mA)	0		0.125

Notes for PCB layout:

1. The RF output pin must match to a 50 Ω strip-line or coplanar waveguide on the BTM510 (no antenna).
2. Ensure there are no exposed conductors under the module to avoid shorts to the module test points.
3. The PCB footprint is provided for guidance only. Users may wish to modify the PCB land dimensions to suit their specific manufacturing or process.

2.5 Audio Design Requirements

The audio inputs of the BTM510/511 can operate in either line input mode or microphone mode. The input circuit has a two stage amplifier – the first stage provides a fixed 24 dB gain and the second a variable gain of between -3 dB and 18 dB. If an input gain of less than 24 dB is selected, then the first stage is switched out and the module is operating in line input mode. The BTM511 can support both Single-Ended and Fully Differential Stereo Line Input (Figure 3).

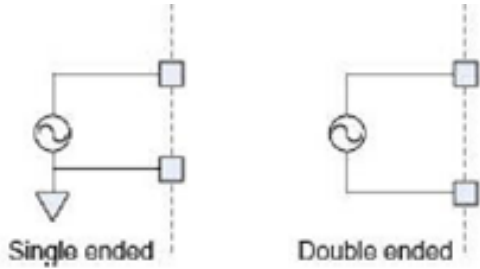

Figure 3: Single and Double Ended Line Inputs

A 15nH / 15pF low pass filter must be added to each input line and placed as close to the BTM511 input pins as possible. Otherwise the BT envelope may be demodulated, causing audio artifacts in the 800 – 1600kHz range that cannot be removed.

If using single-ended line input, it is only necessary to fit one low pass filter per channel. For both Stereo Line In and Microphone modes, you may connect the input signal to either the positive or negative side of the input. The unused input should be connected to either MIC_BIAS or AGND (Note: The ADK-BTM511-v04 design fits one low pass filter on each of the 4 channel inputs).

The Left channel (MIC_AP_C / MIC_AN_C) should be used as the standard mono channel, the Right channel inputs (MIC_BP_C / MIC_BN_C) can be used as an auxiliary mono channel or connected to AGND if unused (Remember to fit the low pass filter on one or both of the unused Right channel inputs).

A typical line input signal has a voltage of 1.75Vrms or 5Vpk-pk. However, the BTM511 can only tolerate 0.4Vrms on the audio inputs. A resistive network can be used to divide the input signal down to 0.4Vrms if necessary.

The audio inputs can operate in either line input mode or microphone mode. The input circuit has a two stage amplifier – the first stage provides a fixed 24 dB gain and the second a variable gain of between -3 dB and 18 dB. If an input gain of less than 24 dB is selected, then the first stage is switched out and the module is operating in line input mode.

When operating in microphone mode the microphone should be biased as shown in [Figure 4](#).

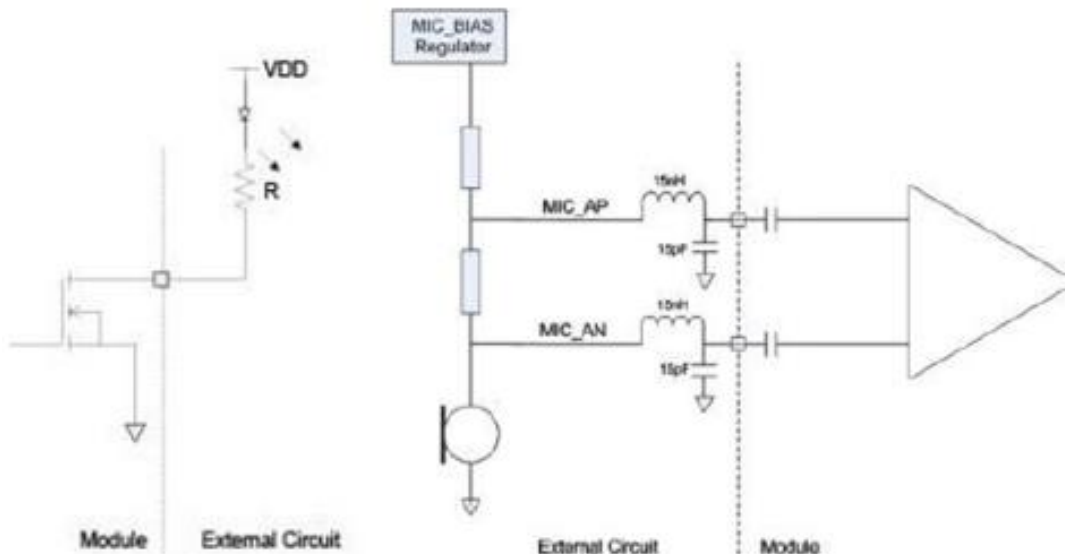

Figure 4: Microphone biasing for microphone mode

The input impedance on the microphone inputs (in microphone mode) is typically 6k Ω . The audio input is designed for use with inputs of between 1 μ A and 10 μ A at 94 dB SPL. If the biasing resistors are set to 1 k Ω , this implies a microphone with sensitivity in the range -40 dBV to -60 dBV.

2.5.1 Speaker Output

The speaker output is capable of driving loads with a minimum impedance of 16 Ω directly.

3 FCC REGULATORY STATEMENTS

3.1 BTM510 FCC and Industry Canada Statements

The Final Equipment user manual must show the following statements:

This device complies with part 15 of the FCC Rules. Operation is subject to the following two conditions: (1) This device may not cause harmful interference, and (2) this device must accept any interference received, including interference that may cause undesired operation.

Changes or modifications not expressly approved by the party responsible for compliance could void the user's authority to operate the equipment.

To comply with the FCC RF exposure compliance requirements, this device and its antenna must not be co-located or operating to conjunction with any other antenna or transmitter.

3.1.1 Considerations for OEM integration:

This module has a limited modular approval. Approval with any other antenna configuration or layout other than that approved will necessitate additional radiated emission testing to be performed.

To inherit the modular approval, the antennas for this transmitter must be installed to provide a separation distance of at least 20 cm from all persons and must not be co-located or operating in conjunction with any other antenna or transmitter.

This module was approved with the following antenna:

RF Solutions: ANT-24G-WHJ-SMA 0 dBi

Operation of this module with any other antenna will require additional testing to be performed.

Co-location with other radio transmitting devices operating concurrently in the same band will require additional testing and certification.

Designers should note the distinction that the FCC makes regarding portable and mobile devices. Mobile devices are defined as products that are not used closer than 20cm to the human body, whereas portable devices can be used closer than 20cm to the body. A device may be used in portable exposure conditions with no restrictions on host platforms when the averaged output power is less than the low power threshold for an uncontrolled environment $\leq 60/f$ (GHz) i.e. 25 mW for a 2.4 Ghz device. The Maximum Power Exposure for the BTM510 has been evaluated and found to comply with the low power threshold for an uncontrolled environment.

Refer to FCC document KDB 447498 for more information on RF exposure procedures and equipment authorization policies for mobile and portable devices.

3.1.2 FCC Labelling Requirement

If the FCC ID is not visible when the module is installed inside another device, then the outside of the device into which the module is installed must also display a label referring to the enclosed module. This exterior label can

use wording such as the following: “Contains Transmitter Module FCC ID: PI4510B” or “Contains FCC ID: PI4510B.” Any similar wording that expresses the same meaning may be used.

3.2 BTM511 FCC and Industry Canada Statements

The user manual must show the following statements:

This device complies with part 15 of the FCC Rules. Operation is subject to the following two conditions: (1) This device may not cause harmful interference, and (2) this device must accept any interference received, including interference that may cause undesired operation.

Changes or modifications not expressly approved by the party responsible for compliance could void the user’s authority to operate the equipment.

To comply with the FCC RF exposure compliance requirements, this device and its antenna must not be co-located or operating to conjunction with any other antenna or transmitter.

3.2.1 Considerations for OEM Integration

To inherit the modular approval, the antennas for this transmitter must be installed to provide a separation distance of at least 20 cm from all persons and must not be co-located or operating in conjunction with any other antenna or transmitter.

Co-location with other radio transmitting devices operating concurrently in the same band requires additional testing and certification.

Designers should note the distinction that the FCC makes regarding portable and mobile devices. Mobile devices are defined as products that are not used closer than 20cm to the human body, whereas portable devices can be used closer than 20cm to the body. A device may be used in portable exposure conditions with no restrictions on host platforms when the averaged output power is less than the low power threshold for an uncontrolled environment $\leq 60/f$ (GHz) i.e. 25 mW for a 2.4 Ghz device. The Maximum Power Exposure for the BTM511 has been evaluated and found to comply with the low power threshold for an uncontrolled environment.

Refer to FCC document KDB 447498 for more information on RF exposure procedures and equipment authorization policies for mobile and portable devices.

3.2.2 FCC Labelling requirement

If the FCC ID is not visible when the module is installed inside another device, then the outside of the device into which the module is installed must also display a label referring to the enclosed module. This exterior label can use wording such as the following: “Contains Transmitter Module FCC ID: PI4511B” or “Contains FCC ID: PI4511B.” Any similar wording that expresses the same meaning may be used.

4 EU DECLARATION OF COMPLIANCE

4.1 Declaration of Conformity – BTM510

Manufacturer:	Laird Technologies
Product:	BTM510
EU Directive:	RTTE 1995/5/EC

Reference standards used for presumption of conformity:

Article #	Requirement	Reference standard(s):
3.1a	Health and Safety	IEC 60950-1:2005 (2nd Ed); +Am 1:2009 +Am2:2013; EN 60950-1: 2006+A11+A1:2010+A12:2011+A2:2013
3.1b	Protection requirements with respect to electromagnetic compatibility	EN 301 489-1 V1.9.2 (2011-09) EN 301 489-17 V2.2.1 (2012-09) Emissions: EN55022:2010 /AC:2011, Class B Immunity: EN61000-4-2:2009 EN61000-4-3:2006 /A1:2008/A2:2010
3.2	Means of the efficient use of the radio frequency spectrum	EN 300 328 V1.8.1 (2012-06)

4.1.1 Declaration

We, Laird Technologies, declare under our sole responsibility that the essential radio test suites have been carried out and that the above product to which this declaration relates is in conformity with all the applicable essential requirements of Article 3 of the EU Directive 1995/5/EC, when used for its intended purpose.

Place of Issue: Laird
 11160 Thompson Ave.
 Lenexa, KS 66219
 USA

Date of Issue: February 2015

Name of Authorized Person: Daniel Waters/Certifications Specialist

Signature: 

4.2 Declaration of Conformity – BTM511

Manufacturer: Laird Technologies

Product: BTM511

EU Directive: RTTE 1995/5/EC

Reference standards used for presumption of conformity:

Article #	Requirement	Reference standard(s):
3.1a	Health and Safety	IEC 60950-1:2005 (2nd Ed); +Am 1:2009 +Am2:2013; EN 60950-1: 2006+A11+A1:2010+A12:2011+A2:2013
3.1b	Protection requirements with respect to electromagnetic compatibility	EN 301 489-1 V1.9.2 (2011-09) EN 301 489-17 V2.2.1 (2012-09) Emissions: EN55022:2010 /AC:2011, Class B Immunity: EN61000-4-2:2009 EN61000-4-3:2006 /A1:2008/A2:2010
3.2	Means of the efficient use of the radio frequency spectrum	EN 300 328 V1.8.1 (2012-06)

4.2.1 Declaration

We, Laird Technologies, declare under our sole responsibility that the essential radio test suites have been carried out and that the above product to which this declaration relates is in conformity with all the applicable essential requirements of Article 3 of the EU Directive 1995/5/EC, when used for its intended purpose.

Place of Issue:	Laird 11160 Thompson Ave. Lenexa, KS 66219 USA
Date of Issue:	February 2015
Name of Authorized Person:	Daniel Waters/Certifications Specialist
Signature:	

5 MECHANICAL DRAWINGS

5.1 BTM510 Mechanical Drawings

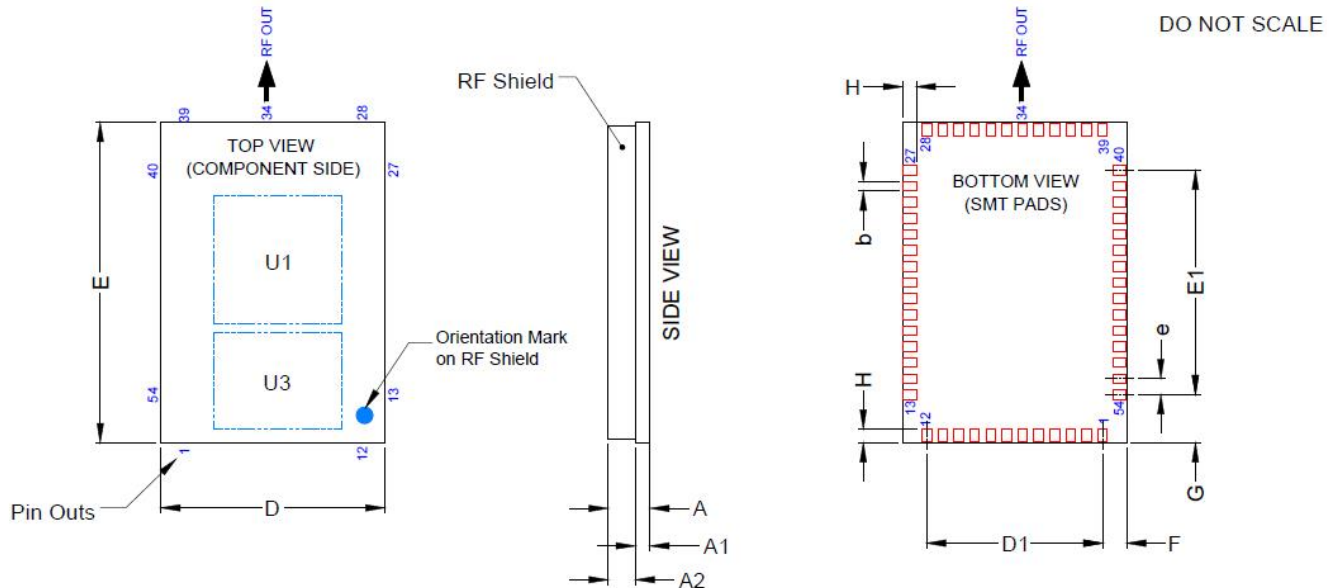

Description	BTM510			
Size	20.0 x 14.0 x 2.95mm			
Pitch	1.0mm			
Dimension	Minimum	Typical	Maximum	Notes
A	2.80	2.95	3.10	
A1	0.81	0.91	1.01	PCB Thickness
A2	1.99	2.04	2.09	RF Shield Height
b	0.55	0.60	0.65	Global pad width
D	13.87	14.0	14.13	
E	19.87	20.0	20.13	
e		1.0		Global pitch
D1		11.0		
E1		14.0		
F		1.50		Pad Centre to Board edge
G		3.00		Pad Centre to Board edge
H		0.85		Global length of pad to edge of board
Units	mm			

Laird TECHNOLOGIES			
Title: Module Package Dimensions			
TOLERANCE UNLESS STATED	MATERIAL	DRAWN	M. Welch
x +/-0.3	x.xx +/-0.03	FRESH	CHECKED N. Hunn
x.xx +/-0.1		COLOR	APPROVED N. Hunn
DIMENSIONS IN MM UNLESS STATED	SCALE	THIRD ANGLE PROJECTION	DWG No: BTV-R-003-POL-03 Page 1 of 3
PROJECT	BTM510		

Notes: An area of 1.5 mm around the module should be reserved as a keep-out area.
 The Development Kit Schematics for this product can be accessed from the following link: [Development Kit Schematics – BTM510](#)

5.2 BTM510 Mechanical Diagrams

PCB LAND PATTERN/DECAL DIMENSIONS

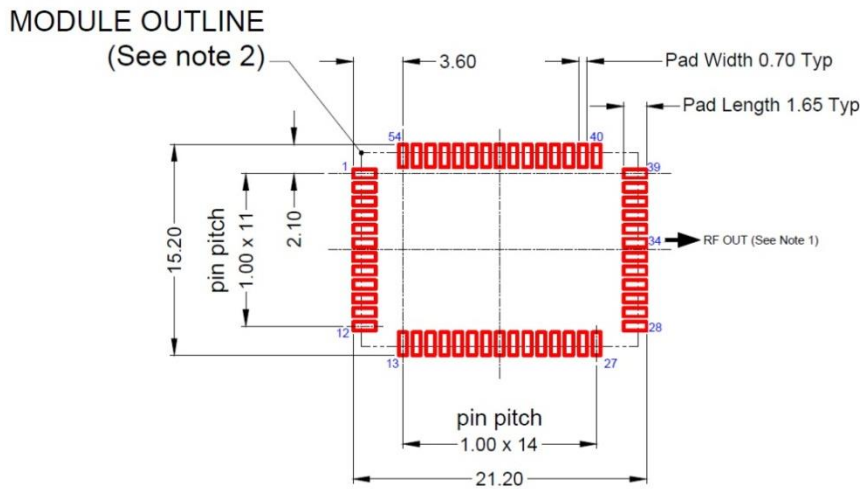

Notes

- 1 Connect External Antenna to RF I/O pin 34 with 50ohm microstrip or coplaner waveguide.
- 2: Ensure no exposed copper under module to avoid shorting to test points on underside of module.
- 3: The user may modify the PCB land pattern dimensions based on their experience and/or process capability.

Note: An area of 1.5 mm around the module should be reserved as a keep-out area. The Development Kit Schematics for this product can be accessed on the software downloads tab of the [BTM51x product page](#).

5.3 BTM510 Mechanical Diagrams

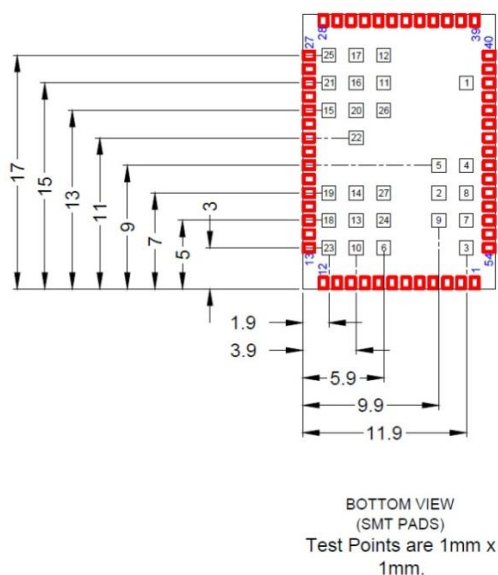

WARNING: Test point dimensions are for reference only. *DO NOT* make electrical connections to these test points. This voids the warranty. Laird does not recommend routing on the top layer underneath the module.

5.4 BTM511 Mechanical Diagrams

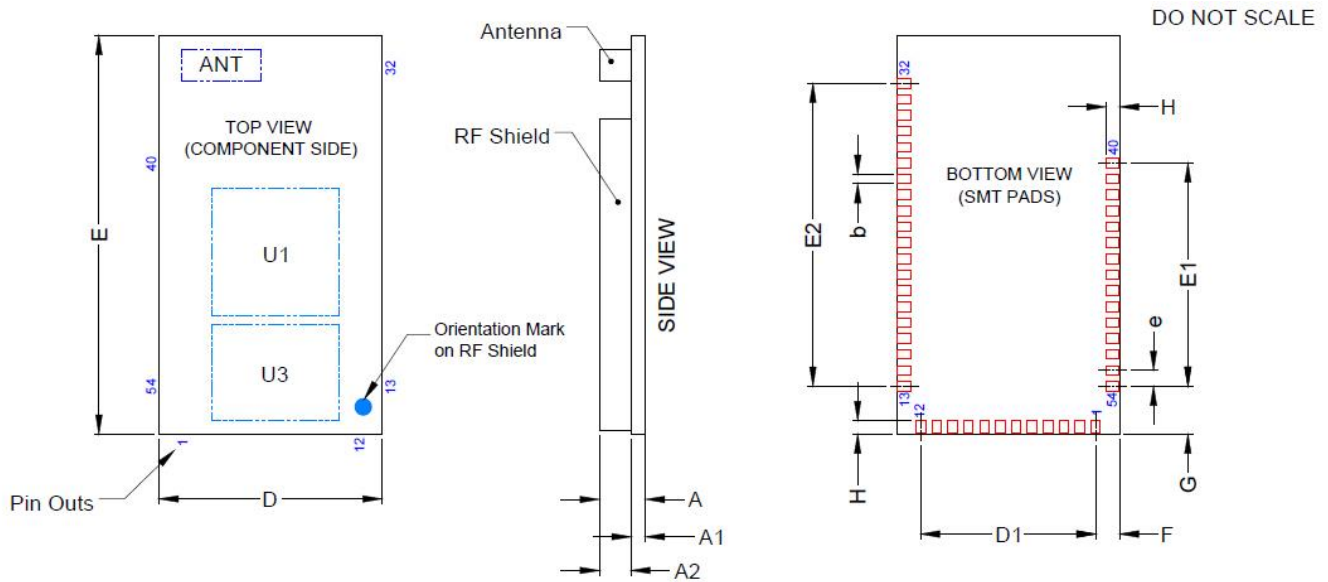

Description	BTM511			
Size	25.0 x 14.0 x 2.95mm			
Pitch	1.0mm			
Dimension	Minimum	Typical	Maximum	Notes
A	2.80	2.95	3.10	PCB Thickness
A1	0.81	0.91	1.01	
A2	1.99	2.04	2.09	
b	0.55	0.60	0.65	Global pad width
D	13.87	14.0	14.13	Global pitch
E	24.87	25.0	25.63	
e		1.0		
D1		11.0		Pad Centre to Board edge
E1		14.0		
E2		19.0		
F		1.50		Pad Centre to Board edge
G		3.00		Global length of pad to edge of board
H		0.85		
Units	mm			

Laird TECHNOLOGIES			
Module Package Dimensions			
TOLERANCE UNLESS STATED		MATERIAL	DRAWN M.Welch
x +/-0.3	x.xx +/-0.03	FINISH	CHECKED N.Hunn
x.xx +/-0.1		COLOR	APPROVED N.Hunn
DIMENSIONS IN MM UNLESS STATED	SCALE	THIRD ANGLE PROJECTION	DWG No: BTVA-R-001-POL-01
PROJECT BTM511			Page 1 of 3

Note: An area of 1.5 mm around the module should be reserved as a keep-out area. The Development Kit Schematics for this product can be accessed on the software downloads tab of the [BTM51x product page](#).

5.5 BTM511 Mechanical Diagrams

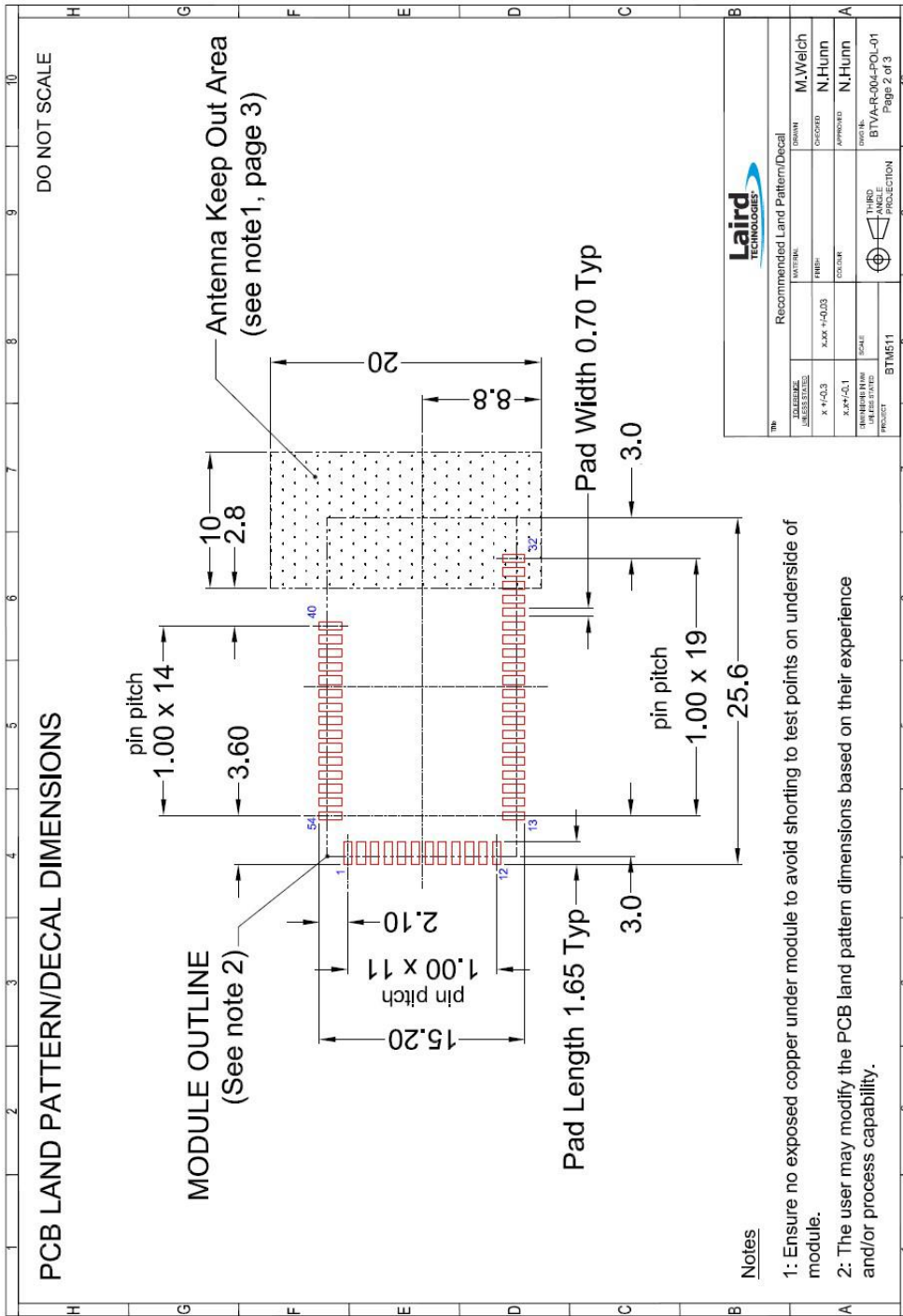

Note: An area of 1.5 mm around the module should be reserved as a keep-out area. The Development Kit Schematics for this product can be accessed on the software downloads tab of the [BTM51x product page](#).

5.6 BTM511 Mechanical Diagrams

APPLICATION NOTES

- 1.) Ensure there is no copper in the antenna keep out area on any layers of the host p.c. board. Also keep all mounting hardware or any metal clear of this area to prevent affecting proper antenna radiation.
- 2.) For best antenna performance the module should be placed on the edge of the host p.c. board and preferably in the corner with the antenna facing the corner.
- 3.) Antenna keep out area definition comes from the module's Developer Kit board which was used for module development and antenna performance evaluation.
- 4.) Ensure no exposed copper under module on host p.c. board to avoid shorting to test points on underside of module.
- 5.) The user may modify the PCB land pattern dimensions based on their experience and/or process capability.

Title		Application Notes	
DESIGNED BY	MATERIAL	DRAWN	M. Welch
CHECKED BY	FINISH	CHECKED	N. Hunn
x +/-0.3	x.xx +/-0.03	APPROVED	N. Hunn
x.xx +/-0.1	COLOR		
DIMENSIONS IN MM UNLESS STATED	SCALE	THIRD ANGLE PROJECTION DWG NO: BTVA-R-001-POL-01 Page 3 of 4	
PROJECT	BTM511		

5.7 BTM511 Mechanical Diagrams

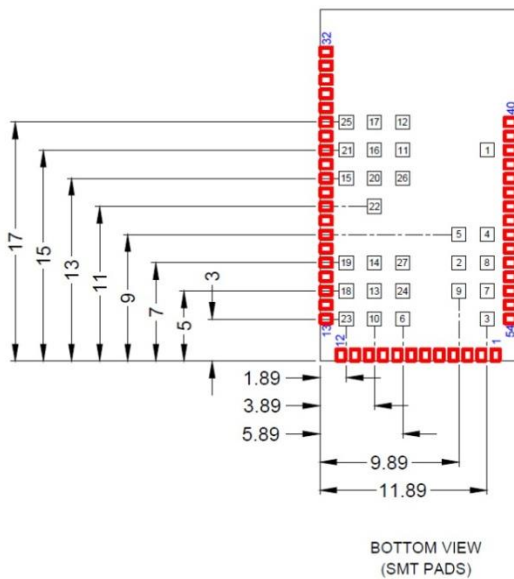

Test Points are 1mm x 1mm.

Title		Module Test Point Locations	
DESIGNED BY	MATERIAL	DRAWN	D Chapman
CHECKED BY	FINISH	CHECKED	
x +/-0.3	x.xx +/-0.03	APPROVED	
x.xx +/-0.1	COLOR		
DIMENSIONS IN MM UNLESS STATED	SCALE	THIRD ANGLE PROJECTION DWG NO: BTVA-R-001-POL-01 Page 4 of 4	
PROJECT	BTM511		

WARNING: Test point dimensions are for reference only. *DO NOT* make electrical connections to these test points. This voids the warranty. Laird does not recommend routing on the top layer underneath the module.

6 ORDERING INFORMATION

Part Number	Description
BTM510	Bluetooth® Multimedia Module (external antenna)
BTM511	Bluetooth® Multimedia Module with integrated antenna
DVK – BTM510	Development Board with BTM510 soldered in place
DVK – BTM511	Development Board with BTM511 soldered in place

6.1 General Comments

Refer to the schematic BTV-R-003.pdf for the Development Kit on the following two pages for examples of typical pin connections. A PDF of the schematic can be downloaded from the product web page.

7 APPLICATION NOTE

7.1 Introduction

Laird Technologies surface mount modules are designed to conform to all major manufacturing guidelines. This application note provides additional guidance beyond the information that is presented in the user’s manual. This application note is a living document and is updated as new information is presented.

The modules are designed to meet the needs of many commercial and industrial applications. The modules are designed to be easily manufactured and conform to current automated manufacturing processes.

7.2 Shipping

Modules are shipped in ESD (Electrostatic Discharge) safe trays that can be loaded into most manufacturers pick and place machines. Layouts of the trays are provided in [Figure 5](#).

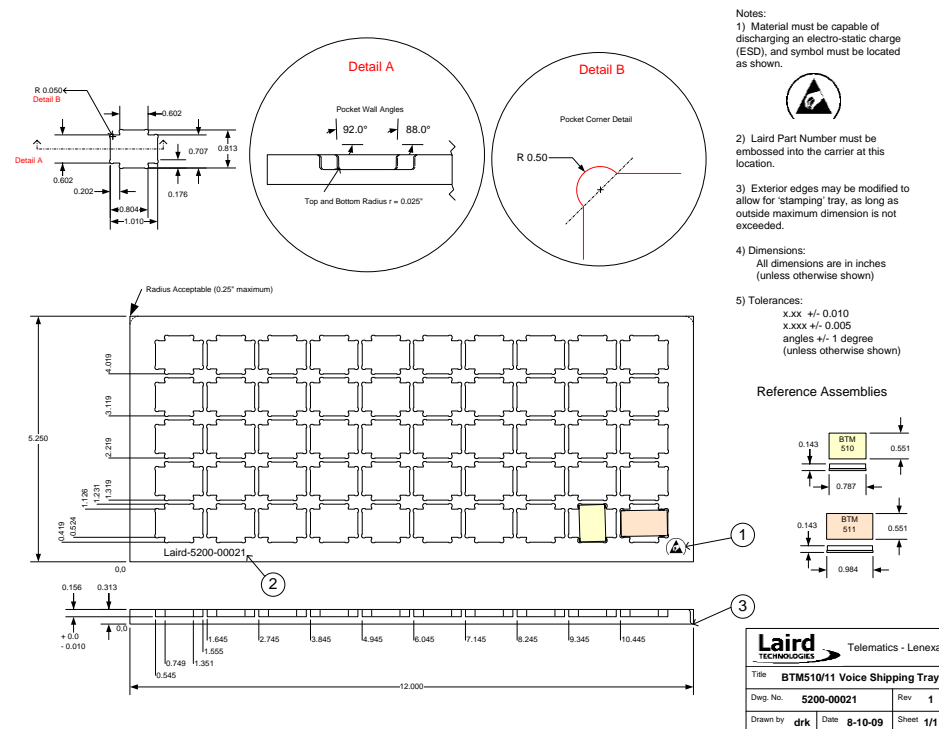

Figure 5: BTM510 and BTM511 shipping tray detail

7.3 Reflow Parameters

Laird surface mount modules are designed to be easily manufactured including reflow soldering to a PCB. It is the responsibility of the customer to choose the appropriate solder paste and to ensure oven temperatures during reflow meet the requirements of the solder paste. Laird’s surface mount modules conform to J-STD-020D1 standards for reflow temperatures.

Important: During reflow, modules should not be above 260° and not for more than 30 seconds.

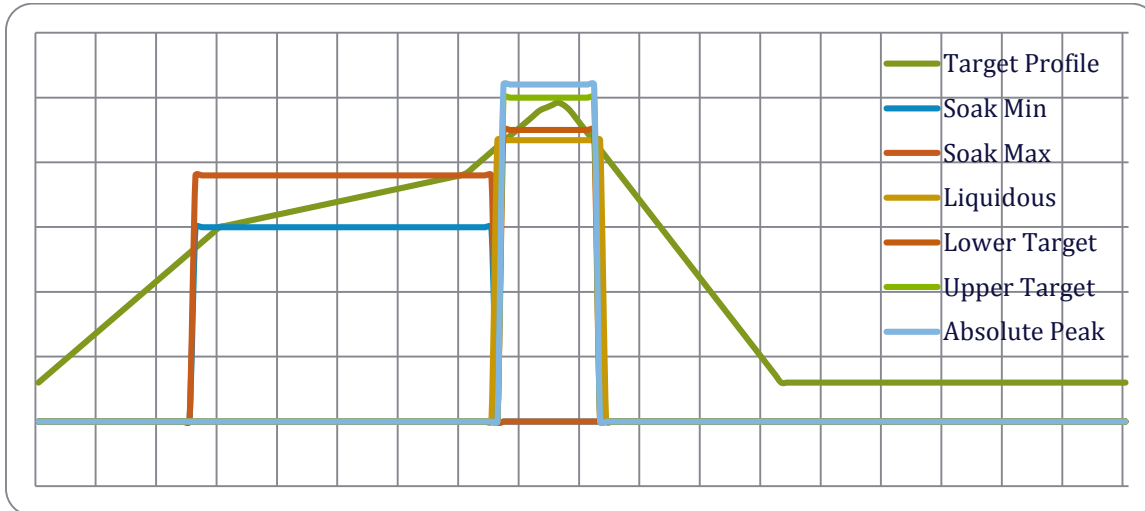

Figure 6: Recommended reflow temperature

Temperatures should not exceed the minimums or maximums presented in [Table 7-1](#): Recommended maximum and minimum temperatures.

Table 7-1: Recommended maximum and minimum temperatures

Specification	Value	Unit
Temperature Inc./Dec. Rate (max)	3	°C / Sec
Temperature Decrease rate (goal)	2-3	°C / Sec
Soak Temp Increase rate (goal)	.5 - 1	°C / Sec
Flux Soak Period (min)	60	Sec
Flux Soak Period (max)	90	Sec
Flux Soak Temp (min)	150	°C
Flux Soak Temp (max)	190	°C
Time Above Liquidous (max)	60	Sec
Time Above Liquidous (min)	20	Sec
Time In Target Reflow Range (goal)	30	Sec
Time At Absolute Peak (max)	30	Sec
Liquidous Temperature (SAC305)	217	°C
Lower Target Reflow Temperature	225	°C
Upper Target Reflow Temperature	250	°C
Absolute Peak Temperature	260	°C

8 BLUETOOTH SIG QUALIFICATION

The BTM510 and BTM511 modules are listed on the Bluetooth SIG website as qualified End Products.

Design Name	Owner	Declaration ID	Link to listing on the SIG website
BTM510, BTM511	Laird	D023160	https://www.bluetooth.org/tpg/QLI_viewQDL.cfm?qid=23160

It is a mandatory requirement of the Bluetooth Special Interest Group (SIG) that every product implementing Bluetooth technology has a Declaration ID. Every Bluetooth design is required to go through the qualification process, even when referencing a Bluetooth Design that already has its own Declaration ID. The Qualification Process requires each company to registered as a member of the Bluetooth SIG – www.bluetooth.org

The following link provides a link to the Bluetooth Registration page:

<https://www.bluetooth.org/login/register/>

For each Bluetooth Design it is necessary to purchase a Declaration ID. This can be done before starting the new qualification, either through invoicing or credit card payment. The fees for the Declaration ID will depend on your membership status, please refer to the following webpage:

<https://www.bluetooth.org/en-us/test-qualification/qualification-overview/fees>

For a detailed procedure of how to obtain a new Declaration ID for your design, please refer to the following SIG document:

https://www.bluetooth.org/DocMan/handlers/DownloadDoc.ashx?doc_id=283698&vId=317486

To start the listing, go to: https://www.bluetooth.org/tpg/QLI_SDoc.cfm.

In step 1, select the option, **Reference a Qualified Design** and enter 16227 in the End Product table entry. You can then select your pre-paid Declaration ID from the drop down menu or go to the Purchase Declaration ID page, (please note that unless the Declaration ID is pre-paid or purchased with a credit card, it will not be possible to proceed until the SIG invoice is paid.

Once all the relevant sections of step 1 are finished, complete steps 2, 3, and 4 as described in the help document. Your new Design will be listed on the SIG website and you can print your Certificate and DoC.

For further information please refer to the following training material:

<https://www.bluetooth.org/en-us/test-qualification/qualification-overview/listing-process-updates>

9 ADDITIONAL ASSISTANCE

Please contact your local sales representative or our support team for further assistance:

Laird Connectivity Products Business Unit
Support Centre: <http://ews-support.lairdtech.com>

Email: wireless.support@lairdtech.com

Phone: Americas: +1-800-492-2320 Option 2

Europe: +44-1628-858-940

Hong Kong: +852 2923 0610

Web: <http://www.lairdtech.com/bluetooth>

10 RELATED DOCUMENTS AND FILES

The following additional BTM510/511 technical documents are also available from the Laird BTM51x Series product page of the [Embedded Wireless Support site](#) under the Documentation tab:

- BTM510/511 Product Brief
- BTM510/511 User Manual

Firmware

- BTM510/511 Firmware Files
- BTM510/511 Firmware Release Notes - Version 18.1.4.0

Development Kit Schematics

- BTM510 Development Kit Schematics
- BTM511 Development Kit Schematics
- BTM511 Development Kit Schematics - Version 4

Development Kit Documentation

- BTM511 Development Kit Quick Start A2DP and AVRCP - Version 2
- BTM511 Development Kit Quick Start HFP - Version 2
- BTM511 Development Kit Quick Start SPP - Version 2
- BTM511 Audio Development Kit (ADK) User Manual - Version 4

The following download are also available from the Laird BTM51x Series product page:

- Laird (EZURiO) Terminal v6.9.0.zip