

SERIOUS™

SIM225

Technical Reference Manual

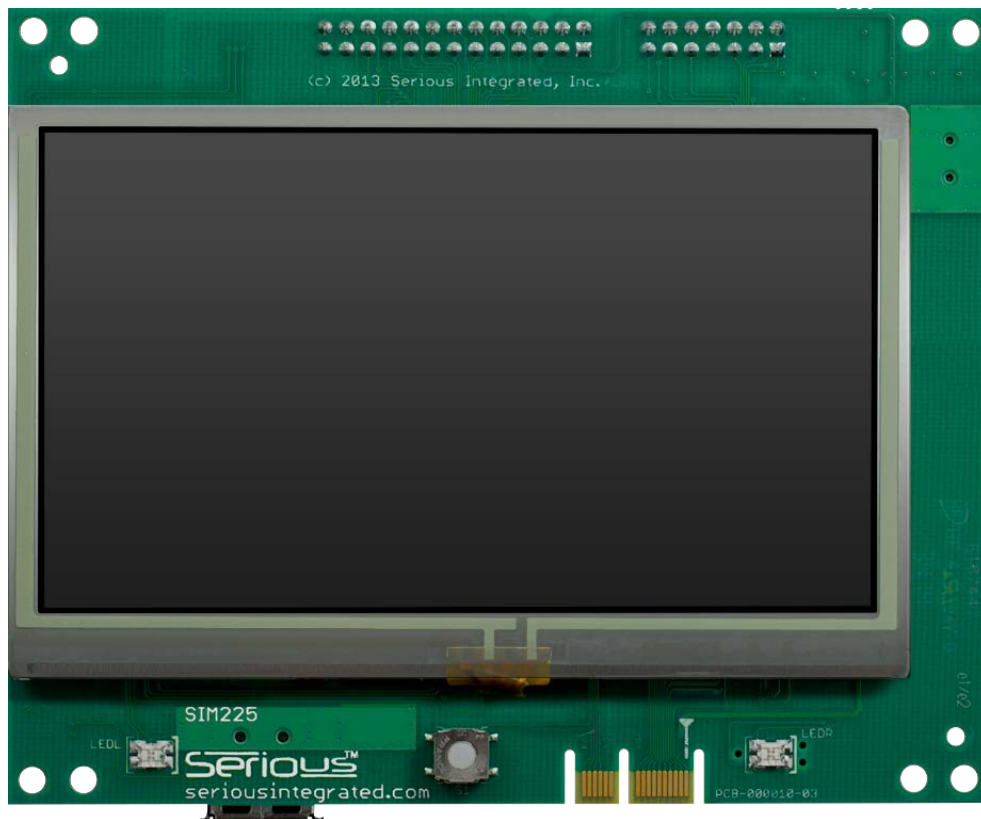

IMPORTANT LEGAL NOTICE

See the latest and complete warranty, licensing and legal information at www.seriousintegrated.com/legal.

Information herein is provided in connection with Serious Integrated, Inc. ("SERIOUS") products.

The products may comprise components designed and manufactured by SERIOUS as well as other vendors. This information may refer to a variety of specifications related to those non-SERIOUS components for informational purposes only, and the user is strongly urged to consult the original manufacturers' data sheets and other documentation for authoritative specifications.

No license, express or implied, by estoppel or otherwise, to any intellectual property rights is granted by this information.

SERIOUS assumes no liability whatsoever, and SERIOUS disclaims any warranties whether express or implied, written, oral, statutory or otherwise relating to the information and its use, including any liability for warranties relating to fitness for a particular purpose, performance, quality, merchantability, or noninfringement of any patent, copyright or other intellectual property right. The user is responsible for determining the suitability of SERIOUS products for the intended application and that applicable specifications are met.

SERIOUS makes no representations or warranties with respect to the accuracy or completeness of the information and may make changes to the information, specifications and product descriptions at any time without notice. Designers should not rely on the absence or characteristics of any features or instructions marked "reserved" or "undefined." SERIOUS reserves these for future definition and shall have no responsibility whatsoever for conflicts or incompatibilities arising from future changes to such features or instructions. SERIOUS products may contain design defects or errors known as errata which may cause the product to deviate from published specifications. Current characterized errata are available upon request.

Use of SERIOUS products in automotive, military, aircraft, space, life-saving or life-sustaining applications or in any systems where failure or malfunction may result in personal injury, death or severe property or environmental damage is entirely at the buyer's risk and the buyer agrees to defend, indemnify and hold harmless SERIOUS from any and all damages, claims, suits or expenses resulting from such use.

TRADEMARKS AND COPYRIGHTS

The "Serious" name and stylized Serious mark are trademarks of Serious Integrated, Inc. The information herein, unless otherwise indicated, is Copyright 2012 Serious Integrated, Inc.

Third party brands and names are the property of their respective owners.

CONTENTS

IMPORTANT LEGAL NOTICE	2
TRADEMARKS AND COPYRIGHTS	2
Document Information and Applicable Products	6
Change History and Applicable Products	6
Document Conventions	6
Introduction	7
Hardware.....	7
Software	8
Usage Models.....	9
Getting started	10
Specifications.....	11
DC Maximum Ratings.....	11
DC Operating Characteristics.....	11
VARIANT A00.....	11
Variants A01, A02, A03, A04.....	12
Subsystem-by-Subsystem DC Operating Characteristics	12
Variant A00	12
Variants A01, A02, A03, A04.....	12
MCU I/O.....	13
AC Timing Characteristics.....	13
Environmental Characteristics.....	13
Physical Characteristics	14
Hardware Overview.....	16
High Performance Renesas RX MCU	16
Graphic Color LCD Display with Direct Drive and Touch Option.....	16
On-Module Peripherals	16
On-Module Memory	17
Communications and Connectors	17
Power.....	18
Module Feature Detail	20
Renesas RX63N/RX631 MCU.....	20
MCU Boot ModeS, Switch S4, and the USB Boot FLASH	21

Graphic LCD Display	23
LCD Direct Drive	23
Touch	24
Power Supplies	27
+5V_MAIN on LiPo Variants	27
+VIN_MAIN on Non-LiPo Variants	28
Main 3.3V Regulation.....	28
Turning SIM225 Off: The PWRDWN# Signal.....	28
LiPo Battery.....	29
USB Device (“Function”) Power	31
LCD Panel Backlight Power	31
USB Host Power	31
Clock/Calendar Battery Power	32
Memory	33
Serial FLASH	33
SDRAM.....	33
EEPROM.....	34
Serialization and Variant/Version Identification.....	34
Universal Serial Bus (USB)	35
Device IDs.....	35
Software.....	36
Device Port USB1.....	36
Embedded Host Port USB0.....	37
Audio	37
Piezo Sounder.....	37
DAC Outputs	38
Speaker/Amplifier	38
Temperature Sensing.....	38
MCU On-Chip Temperature Sensor	38
PCB Temperature Sensor	38
Clocks, Oscillators, and Time Keeping	39
CPU and Peripheral Clocks	40
MCU On-Chip Battery Backed Real-Time Clock/Calendar	40

User Pushbutton Switch and LEDs.....	41
Connectors	41
Baseboard Connector.....	41
PCB Edge Connector.....	43
Tag-Connect Programming Port.....	45
Power and Communications Connector.....	46
LiPo Battery/Switch Connector.....	47
USB Mini-B Device Connector	47
USB A Host Connector.....	47
FFC Expansion Connector.....	48
JTAG Connector	48
Additional Information	49

DOCUMENT INFORMATION AND APPLICABLE PRODUCTS

CHANGE HISTORY AND APPLICABLE PRODUCTS

The following table summarizes major changes to this document and the applicable versions of the product corresponding to this document:

Doc Vers	Date	For HW Variants/Versions	Major Changes
A0	13 Dec 12	A00 v1.0	▶ Initial prerelease version
A1	08 Jan 13	A00 v1.0	▶ First public release
A2	29 Jun 13	A00 thru A04 v1.0	▶ Fixed mechanical drawing; LCD was incorrectly 0.012" right ▶ Updated info for production A01..A04
A3	05 Aug 13	All	▶ Clarified boot modes and DIP switch with new picture ▶ Added updated variant feature table

DOCUMENT CONVENTIONS



This symbol indicates an advanced tip for hardware or software designers to extract interesting or unique value from the Serious Integrated Module.



WARNING: You can damage your board, damage attached systems, overheat or cause things to catch fire if you do not heed these warnings.



Notes with this symbol are related to license and associated legal issues you need to understand to use this software. We're big believers in honoring license agreements, so please help the industry by respecting intellectual property ownership.



Some hardware features may be preconfigured or permanently reserved for use by the [SHIP Engine](#) software (the GUI management engine component of the [Serious Human Interface™ Platform](#)). Notes with this symbol indicate where the module comes pre-configured or uses these resources.

INTRODUCTION

The SIM225 family of Serious Integrated Modules is a series of complete intelligent 4.30" WQVGA graphic front panels, some with touch capability.

These cost-effective modules are designed for use by Original Equipment Manufacturers (OEMs), custom design shops, and hobbyists to add sophisticated and user-friendly graphical user interfaces to their products.

HARDWARE

SIM225 family features include:

- ▶ 4.3" WQVGA 480×272 color TFT display
 - Various touch panel options
- ▶ 100MHz 32-bit Renesas RX631/RX63N MCU
 - 128KB RAM, 512KB-2MB FLASH, Direct Drive
 - Integrated Temp Sensor & RTCC
- ▶ On Module Memory
 - 8-16MB [SDRAM](#)
 - 8-16MB serial FLASH + 2Kbit EEPROM
- ▶ Extensive I/O
 - 24-Pin [FFC Expansion Connector](#) (GPIO, +5V, RESET#, UART; RMII on 63N-based units)
 - Serious 7-pin system-to-system [Power and Communications Connector](#)
 - 26-Pin [Baseboard Connector](#) (GPIO, +5V, RESET#, 2xUART, I2C, SPI, audio, CAN and more)
 - 14-Pin [JTAG Connector](#)
 - [USB Mini-B Device Connector](#)
 - [USB A Host Connector](#)
 - [Tag-Connect Programming Port](#)
- ▶ -20 to 70°C extended operating temperature

Within the SIM225 are numerous family members, or “variants”. Each variant has a slightly different set of features and price points for an OEM to select the appropriate feature/cost point for their specific application.

Consult the latest SIM225 Product Brief for a listing of current variants and options. As of the time of this document’s publish date, the variants/options are:

SIM225- A00 A01 A02 A03 A04					
MCU RX Family	63N	63N	63N	631	631
MCU FLASH (KB)	2048	768	768	512	512
MCU RAM (KB)	128	128	128	128	128
SDRAM/Serial FLASH (MB)	16/16	16/16	16/16	8/8	8/8
LCD Touch	R4	R4		R4	
LCD Brightness (NITs)	300	300	330	300	330
7 Pin Power/UART Connectors	✓	✓	✓	✓	✓
PCB Edge Program/Test	✓	✓	✓	✓	✓
USB2.0 FS device circuitry	✓	✓	✓	✓	✓
USB2.0 FS device mini-B	✓	✓	✓		
USB2.0 FS 150mA host	✓	✓	✓		
Speaker/Amplifier	✓				
Piezo Sounder		✓	✓		
LiPo Battery Support	✓				
Battery Backed Clock	✓	✓	✓		
PCB Temp Sensor	✓	✓	✓		
26 Pin 0.1" I/O Expansion Header	✓	✓	✓		
24-Pin FFC (GPIO, +5V, UART)	✓	✓	✓		
RMI on 24-Pin FFC	✓	✓	✓		
Front LEDs & User Button	✓	✓	✓		

SOFTWARE

The SIM225 is supported by a growing collection of Renesas, open source, as well as *Serious* proprietary software, allowing designers to gain confidence that their essential software can not only get it done, but perform to the needed end result. Available at mySerious.com for download, SIM225 programmers can obtain an out-of-the-box experience with a pre-ported version of the [Renesas GAPI library](#) on [Micrium uCOS-III](#), [Segger embOS](#) and [FreeRTOS](#) operating systems. The SIM225 includes full single-unit production licenses of the Micrium and Segger kernels for use with each module.



For even faster development, the [Serious Human Interface™ Platform](#) offers PC-based GUI design tools and rapid GUI prototyping, development, and deployment. With minimal coding, you can create attractive and functional GUIs in a fraction of the time of traditional C-based development. See www.seriousintegrated.com/SHIP for details.

It is very difficult to know, as a designer selecting the hardware for a graphic/touch interface, if the result after many months of software and graphic design will have acceptable performance. Will the system be responsive? Will it be visually attractive? Will the look-and-feel be consistent with the company’s brand image? *Serious* addresses these OEM designer challenges by delivering video best-of-class GUI examples, fostering community demos and solutions, and providing software, tools, and consulting services.

USAGE MODELS

The SIM225 can be used as a stand-alone controller for a whole system – where all the intelligence and control is in the SIM225 with few external components – or can act just as a front-panel touch/graphic human interface, a sort of “super-interface”, to an attached intelligent system. In reality, there are many usage models in between these extremes.

There is often additional software and hardware functionality in the user’s system beyond the SIM225; for example, a machine control system. The SIM225 is equipped with several connectors allowing simple communications to an external hardware system.

Often a designer has an existing product with a traditional button-and-segment-LCD user interface and is seeking to give the product an “extreme makeover” with a new front graphic/touch panel. The existing design may already be an intelligent system, such as a pool control system including motor controllers, valve relays, sensors, and power supply circuits as well as its own microcontroller on a “baseboard” PCB. In some designs, this baseboard has a wire harness to a simple front panel interface. In others, the baseboard is combined with front panel buttons and indicators. All user configuration and operation is managed by the existing baseboard and its software. Rather than completely redesigning the hardware and software of the existing OEM system, the old front panel can be replaced by a simple UART+Power connection to one of the SIM225’s connectors. The designer can then architect inter-board messages such as “pump is on” which could be sent over the UART causing visual indicators to appear or change on the display. A GUI on the SIM225 could change user preferences, for instance, sending back messages such as “pump on days: MWF” which the baseboard may store in its configuration EEPROM.

The possibilities are endless: the SIM225 module contains not only a powerful MCU but also a suite of hardware features that are commonly needed in many designs. A high-end thermostat or alarm panel, for example, could be as simple as a SIM225 connected to another PCB with a few relays and a battery.

GETTING STARTED

The SIM225 comes pre-configured with a demo program loaded in the system FLASH. To startup the system, plug a USB cable from your PC or USB supply into the USB device Mini-B connector. The system will use a maximum of 500mA of current from the USB connection when in operation.

The demo will start running and displaying info on the LCD screen. For more getting started information and out-of-the-box tips, see www.seriousintegrated.com/oob.

Some SIM225 variants, for example the SIM225-A03 and SIM225-A04, do not have the USB device connector populated. However, all SIM225's have the USB device circuit available via the [PCB Edge Connector](#).

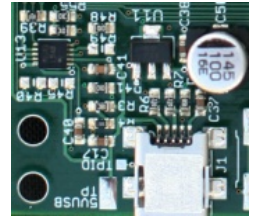

An inexpensive [Serious Programming Adapter 100 \(SPA100\)](#) can connect to this edge connector and expose the USB device port to a physical USB Mini-B connector.



Several connectors may be used to power the SIM225. See [Power Supplies](#).

SPECIFICATIONS

DC MAXIMUM RATINGS

The following are absolute maximum limits for the specified variants:

Specification	Variant	DC Limits			
		Min	Typ	Max	Units
Input Supply Voltage +5V_USB	All	4.75	5.00	5.25	V
Input Supply Voltage +5V_EXT/+VEXT	A00	4.35	5.00	5.25	V
	A01	4.50 ¹	5.00	5.25	V
	A02	4.50 ¹	5.00	5.25	V
	A01	3.60 ²	5.00	5.25	V
	A02	3.60 ²	5.00	5.25	V
	A03	3.60	5.00	5.50	V
	A04	3.60	5.00	5.50	V
LiPo Battery Rated Voltage	A00	-	3.70	4.30	V

Notes: ¹USB Host circuit enabled
² USB Host circuit never enabled

DC OPERATING CHARACTERISTICS

VARIANT A00

The following DC characteristics apply **only** to variants with LiPo capabilities, including the SIM225-A00.

Specification	LCD Backlight State	USB Host State	LiPo State ⁴	Audio Amp State	Range			
					Min	Typ	Max	Units
Input Supply Current +5V_USB	off	off	N	off	25 ^{1,3}	tbd ^{1,2}		mA
	100%	off	N	off	141 ^{1,3}	tbd ^{1,2}		mA
	100%	on	N	on	141 ^{1,3}	tbd ^{1,2}		mA
	any	any	C	any		500		mA
Input Supply Current +5V_EXT	off	off	N	off	25 ^{1,3}	tbd ^{1,2}		mA
	100%	off	N	off	141 ^{1,3}	tbd ^{1,2}		mA
	100%	on	N	on	tbd ^{1,3}	tbd ^{1,2}		mA
	any	any	C	any		tbd ^{1,2}		mA
Charging Current to LiPo Battery	any	any	C	any		480		mA

Notes: ¹Any additional external current draw from the module is in addition to this value
²At minimum voltage on supply
³At typical input supply voltage
⁴ LiPo Status: N = not draining nor charging, or not present, C = Charging, D = Draining

VARIANTS A01, A02, A03, A04

The following DC characteristics apply **only** to all variants without LiPo capabilities, including the SIM225-A01, A02, A03, and A04.

Specification	LCD Backlight State	USB Host Boost	Range				
			Typ ^{1,2,5}	Typ ^{1,3,5}	Max ^{1,2}	Max ^{1,3}	Units
Input Supply Current +5V_USBF/+VEXT	RESET		58	45			mW
	off	off	284	294	tbd	tbd	mW
	100%	off	1374	1225	tbd	tbd	mW
	100%	on ⁴	tbd	Tbd	tbd	tbd	mW

- Notes:
- ¹Any additional external current draw from the module is in addition to this value
 - ²At minimum voltage on supply
 - ³At typical input supply voltage
 - ⁴No device inserted; device power is in addition to this number plus typical conversion loss of 10%.
 - ⁵Measured

SUBSYSTEM-BY-SUBSYSTEM DC OPERATING CHARACTERISTICS

The amount of power necessary for SIM225 to function is highly dependent on how you use the various features of the SIM225, especially the major power consumers. If your application does not enable these features, the typical and maximum power numbers can be appropriately subtracted from the maximums for the SIM respectively. Assuming typical switching conversion efficiency, the power breakdown of the elements is as follows.

VARIANT A00

The following DC characteristics apply **only** to variants with LiPo capabilities, including the SIM225-A00.

+5V_MAIN Powered Subsystem	Local Power Required (mW) ¹			+5V_MAIN to Local Conversion Efficiency (typ)	+5V_MAIN Power Required (mW) ¹		
	Min	Typ	Max		Min	Typ	Max
Battery Charging (+5V_USBF)			2500	100%			2500
Battery Charging (+5V_EXT)			4750	100%			4750
LCD Backlight		800	850	86%	931		1000
USB Host		375	750	90%	417		833
Audio Amplifier/Speaker		700	1000	100%	700		1000
DRAM 8MB or 16MB		200	594	92%	217		645
SFLASH 8MB or 16MB		33	83	92%	36		90
Resistive Touch		33	56	92%	36		61
USB Host		tbd ²	tbd ²	90%	tbd ²		tbd ²
Other logic and miscellaneous							

- Notes:
- ¹At typical input supply voltage
 - ²No device inserted; device power is in addition to this number plus typical conversion loss of 10%.

VARIANTS A01, A02, A03, A04

The following DC characteristics apply **only** to all variants without LiPo capabilities, including the SIM225-A01, A02, A03, and A04.

+VIN_MAIN Powered Subsystem	Circuit-Local Power Required (mW) ¹			+VEXT to Local Conversion Efficiency (typ)	+VEXT Power Required (mW) ¹		
	Min	Typ	Max		Min	Typ	Max
LCD (backlight)		800	850	86%	931	1000	
LCD (logic)		tbd	tbd	92%	tbd	tbd	
Piezo w/Boost Enabled		3	12	80%	4	15	
MCU		178	370	92%	194	402	
DRAM 8MB or 16MB		200	594	92%	217	645	
SFLASH 8MB or 16MB		33	83	92%	36	90	
Resistive Touch		33	56	92%	36	61	
USB Host		tbd ²	tbd ²	90%	tbd ²	tbd ²	
Other logic and miscellaneous							

Notes: ¹At typical input supply voltage

²No device inserted; device power is in addition to this number plus typical conversion loss of 10%.

MCU I/O

Many I/O signals on the SIM225 are directly and exclusively connected to RX MCU pins. Consult the [RX63N/RX631](#) data sheet for complete specifications of each pin.



There are specific power limitations on the RX MCU pins. Consult the [RX63N/RX631](#) data sheet for more information. **Exceeding these limits may damage your board, damage attached systems, overheat or cause things to catch fire.**

AC TIMING CHARACTERISTICS

The AC timing characteristics at the module level are governed by the underlying AC timing characteristics of the individual components. Consult the component data sheets for more information.



The no-cost SHIPWare source code as well as the full-featured [Serious Human Interface™ Platform](#) software initializes the MCU and other SIM components for correct operation.

ENVIRONMENTAL CHARACTERISTICS

Specification	Permissible Range			Units
	Min	Typ	Max	
Operating Temperature	-20		+70	C
Storage Temperature	-30		+80	C
Humidity			90% (@60C)	RH

PHYSICAL CHARACTERISTICS

The outer dimensions of the SIM225 are approximately 116 x 94 x 15.57 mm. Thickness of the module is 1.15mm less for variants without touch capabilities.



Mechanical drawings, SolidWorks, and STEP models are available for most SIMs. Visit www.seriousintegrated.com/docs for more information.

The cross-sectional dimensions of SIM225 variants with touch panel support (e.g. SIM225-A00, A01, and A03) are as follows:

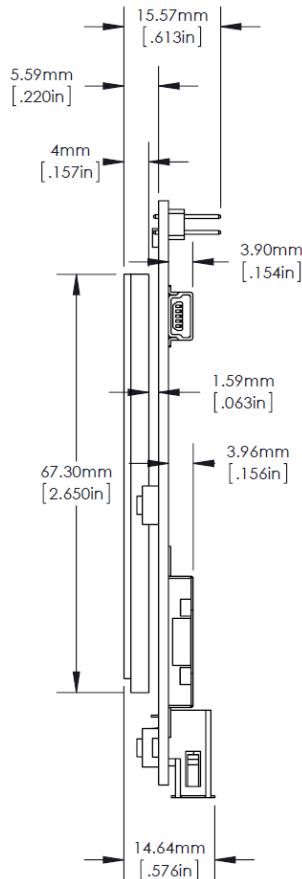

For units without touch support, the surface glass and plastic touch layers on the LCD are not present, reducing the height of the surface of the LCD by 1.15mm.

The positioning of the LCD glass and various connectors is well defined in the SolidWorks/STEP files, and are shown here for reference:

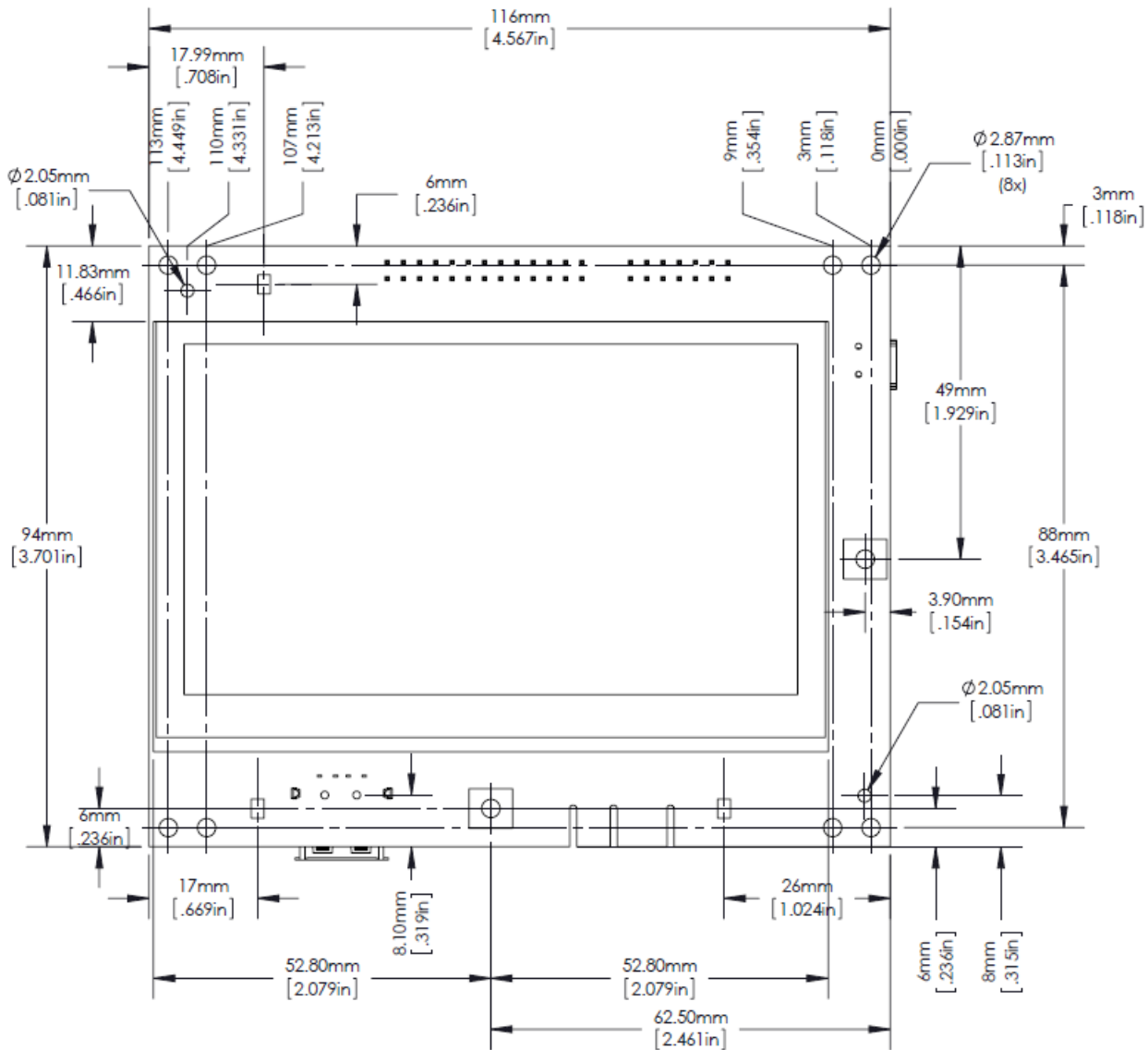

Early versions of the mechanical specification had the LCD screen incorrectly shifted right by 0.012". Current mechanical drawings, SolidWorks, and STEP models at www.seriousintegrated.com/docs have corrected this issue.

HARDWARE OVERVIEW

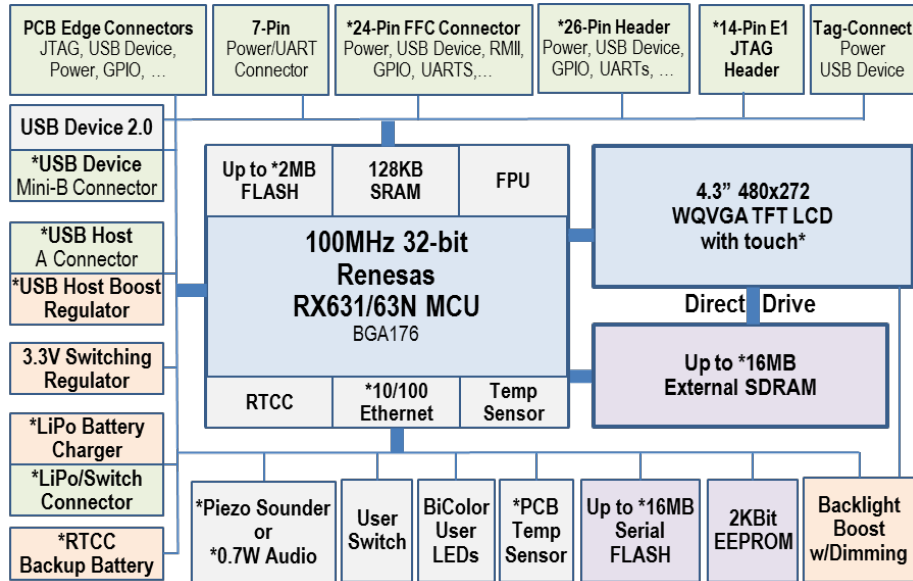

SIM225 Hardware Block Diagram *options depend on family member

Not all features are available on all SIM225 family members.

HIGH PERFORMANCE RENESAS RX MCU

The heart of the SIM225 is the 32-bit Renesas [RX63N/RX631](#) microcontroller (MCU) with up to 2MB of zero wait state FLASH, 128KB RAM, and FPU. This powerful MCU is equipped with extensive analog and digital peripherals and, with software, can deliver an excellent user interface experience. On the SIM225, the MCU should be operated at 96MHz to ensure usable timing sources for peripherals such as USB.

GRAPHIC COLOR LCD DISPLAY WITH DIRECT DRIVE AND TOUCH OPTION

The SIM225's Liquid Crystal Display ("LCD" or "glass") has an on-glass row-column driver chip for illuminating pixels but has no on-glass frame buffer or memory. The pixel data must be delivered at approximately 60Hz per complete frame by the MCU, and stored and managed in the SDRAM attached to the MCU. The RX631/63N MCU family has no hardware graphics engine, but rather implements a "Direct Drive" architecture whereby the MCU's DMA, timers, and other peripherals are used to deliver pixel data directly from SDRAM to the LCD at the specific timing required by the LCD. The performance of the RX MCU can enable surprising GUI performance and the Direct Drive architecture on the RX requires few external components. This combination can yield a modern-looking GUI, including alpha blending effects, with low system cost.

Some SIM225 family members ("variants") include an integrated 4-wire resistive touch feature: a resistive film over the LCD returns an analog voltage in two dimensions which can be read by the MCU's 12-bit analog-to-digital converter channels and translated with a simple algorithm into a pixel hit position.

ON-MODULE PERIPHERALS

The SIM225 contains numerous on-module peripherals – many common to a vast and diverse set of OEM applications, including a Real Time Clock/Calendar (RTCC) (battery-backed on some modules), temperature sensor, USB device, USB host, serial FLASH, a high speed UART, EEPROM, bi-color indicator LEDs, a user "select" switch, and more.

ON-MODULE MEMORY

The SIM225 module has a variety of memory for storage of program, data, images, parameters, etc.:

FLASH Memory:

- › Up to 2 MB zero wait state FLASH program memory within the [RX63N/RX631](#)
- › [Up to 16Mbytes \(128 Mbits\) serial FLASH](#) memory attached via dedicated SPI

EEPROM

- › 2Kbits [EEPROM](#)

RAM

- › 128KBytes RAM within the [RX63N/RX631](#)
- › Up to 2MBytes of external SDRAM

COMMUNICATIONS AND CONNECTORS

The SIM225 has numerous off-module communication ports and connectors. Some may or may not be available on specific SIM225 family members.

- › 26-Pin [Baseboard Connector](#) with extensive I/O including:
 - › SPI, I2C, CAN, and high-speed UART ports
 - › USB device connections
 - › Power input/output
 - › GPIO
 - › DA0/DA1 mono/stereo audio and/or general purpose DAC outputs
- › [PCB Edge Connector](#) for high speed programming and MCU-level debugging, including:
 - › SPI and high-speed UART ports
 - › JTAG for connection (with adapter) to 14-pin [Renesas E1](#), [Segger J-Link](#) and equivalent devices
 - › USB 2.0 device port (shared with USB mini-B connector if present)
- › [USB Mini-B Device Port](#)
 - › USB 2.0 full speed device port
- › [USB Host Port](#)
 - › USB 2.0 full speed embedded host port capable of supplying up to 150mA
- › [24-Pin Flex Cable Connector](#) with extensive I/O including:
 - › Reduced MII (RMII) Ethernet connection (if the SIM225 is equipped with an RX63N MCU)
 - › SPI, I2C, CAN, and high-speed UART ports
- › 7-Pin Wire-to-Board [Power and Communications Connector](#)
 - › Suitable for an inexpensive wire harness with latching plug connection
 - › UART, +5V in, +3V3 out, and RESET#
- › 5-Pin Wire-to-Board [LiPo Battery/Switch Connector](#)
 - › Suitable for an inexpensive wire harness with latching plug connection
 - › Connects to optional LiPo battery and low current power switch
- › 14-Pin [JTAG Connector](#)
 - › For connection to standard Renesas E1/E10 and Segger J-Link programmer/debuggers
- › [Tag-Connect](#) port for a convenient in-service programming capability

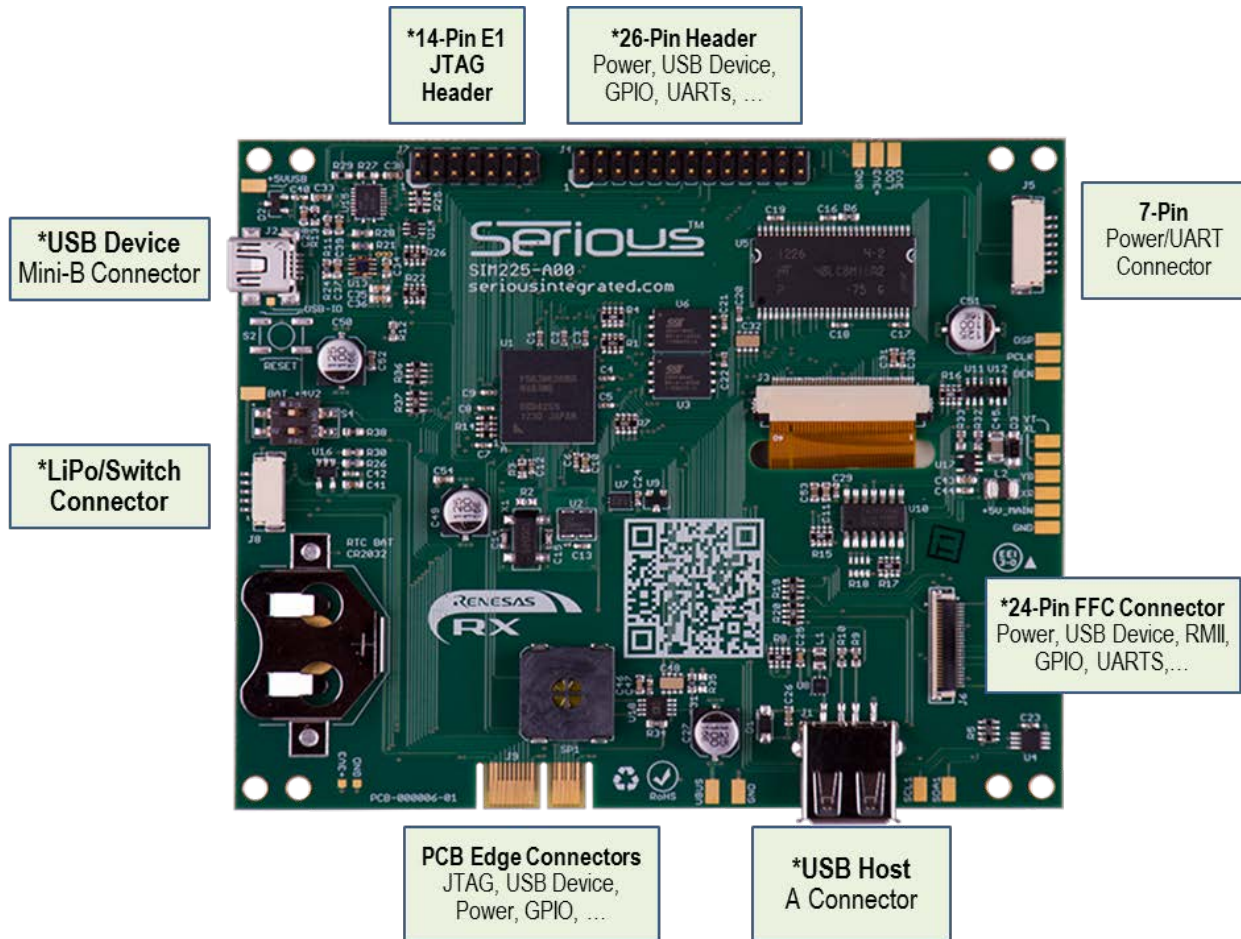

POWER

The SIM225 module can be powered in several ways:

- ▶ USB Device Power (+5V_USB) available on numerous different connectors (if present):
 - ▶ [USB Mini-B connector](#),
 - ▶ [PCB Edge Connector](#)
 - ▶ [Tag-Connect](#)
 - ▶ [Baseboard Connector](#)
- ▶ External 5VDC (+5V_EXT/+VEXT) available on several connectors (if present):
 - ▶ [Power and Communications Connector](#)
 - ▶ [FFC Expansion Connector](#)
 - ▶ [Baseboard Connector](#)
- ▶ External LiPo battery input (BAT_+4V2) available on several connectors (if present):
 - ▶ [Baseboard Connector](#)
 - ▶ [LiPo Battery/Switch Connector](#)

For development, it is common to power the module from the device USB connector by connecting the SIM to a PC or powered USB hub. The complete module may require as much as 500mA from the USB power supply, so ensure that the USB hub or USB power supply can deliver enough power.

 The SIM225 can support concurrent connection from some of these supplies. See the [Power Supplies](#) for details.

MODULE FEATURE DETAIL

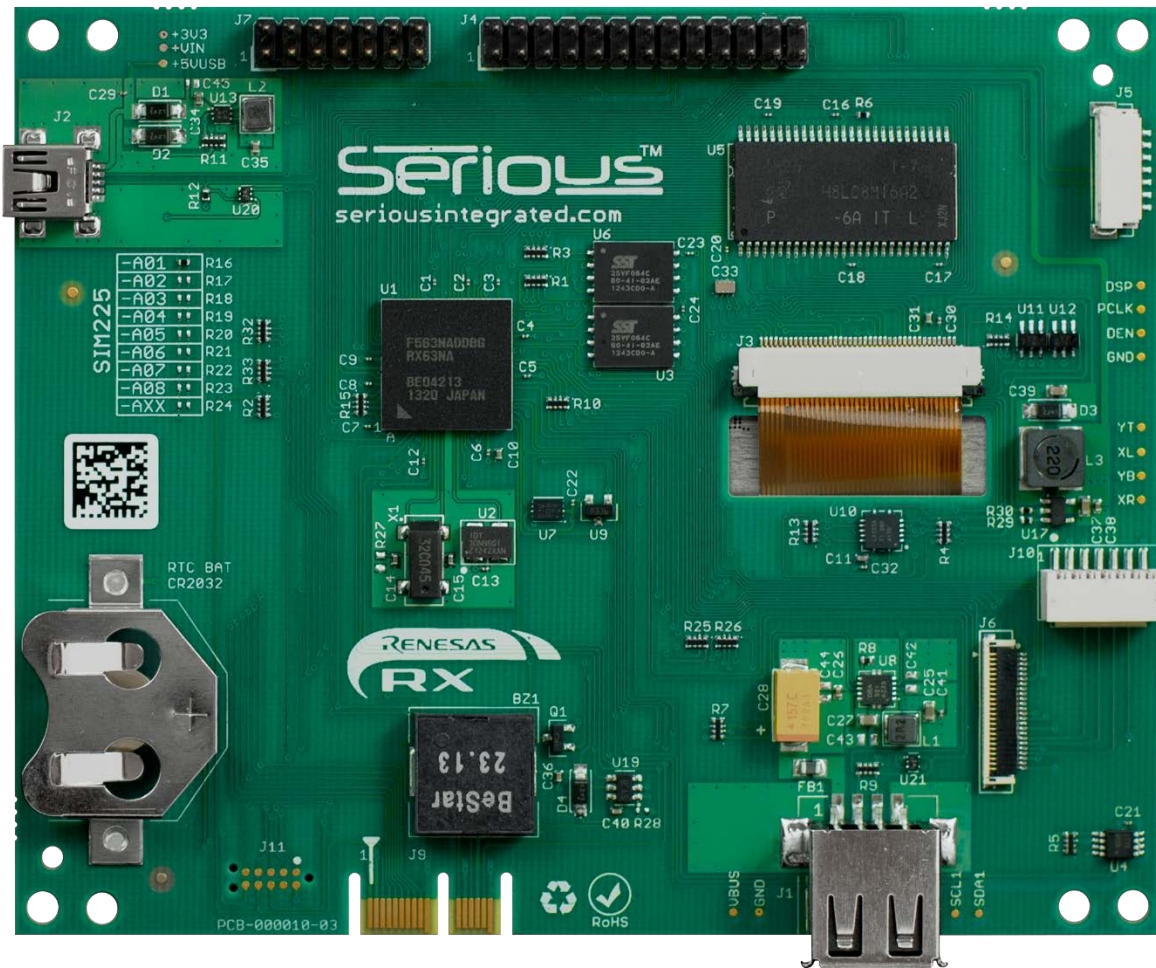

RENESAS RX63N/RX631 MCU

At the heart of the SIM225 is a 100MHz 32-bit Renesas [RX63N/RX631](#) MCU equipped with extensive analog and digital peripherals. Features include:

MCU Core & Memory

- ▶ 100MHz 32-bit core
- ▶ Up to 2MBytes FLASH – zero wait state at up to 100MHz
- ▶ 128KBytes RAM – zero wait state at 100MHz
- ▶ Single cycle multiply and hardware divide unit
- ▶ Single precision hardware Floating Point Unit (FPU)
- ▶ 16 32-bit registers
- ▶ Fast context switching/interrupt response, including a dedicated “fast interrupt”

Peripherals include:

- ▶ Two USB 2.0 ports (one device, one host)
- ▶ SDRAM external bus controller
- ▶ Four-channel general hardware DMA controller plus Data Transfer Control
- ▶ A/D Converters: 4 channels x 2 units 10-bit or 8 channels x 1 unit 12-bit
- ▶ Hardware real time clock/calendar (RTCC) with battery backup capability
- ▶ D/A Converter: 10-bit x 2 channels
- ▶ Watchdog timer
- ▶ Numerous SPI, I2C, CAN, and high-speed-capable serial ports



Some SIM225 family members feature the RX63N MCU, which has the Ethernet peripheral, and others the RX631 MCU without Ethernet. Renesas provides extensive documentation of the [RX63N/RX631](#) MCU family as well as example software: consult [their website](#). In addition, many community resources are available for RX family developers, including the [rxmcu](#) and [renesasrulz](#) websites.

Note that on the SIM225, the MCU should normally be operated at 96MHz to ensure the clocking system can generate the appropriate clocks for SRAM, USB, and other peripherals.

The following table summarizes the size, speed, and configuration of each family member:

SIM225 Variant	Renesas RX63x Family Member			
	Part Number	FLASH	RAM	Peripherals
-A00	R5F63NEDDBG	2MB	128KB	Ethernet, CAN
-A01	R5F63NADDBG	768KB	128KB	Ethernet, CAN
-A02	R5F63NADDBG	768KB	128KB	Ethernet, CAN
-A03	R5F6318DDBG	512KB	128KB	CAN
-A04	R5F6318DDBG	512KB	128KB	CAN

MCU BOOT MODES, SWITCH S4, AND THE USB BOOT FLASH

Three separate FLASH memory areas are available inside the RX MCU: Program FLASH, Data FLASH, and USB Boot Mode FLASH as well as one Boot Mode ROM. Three “boot modes” are available on the RX631/RX63N MCU family based on the state of the **MD** and **PC7** pins when the **RESET#** signal is released. Depending on which of the three boot modes is determined at reset, the MCU jumps to a corresponding start address for code execution.

MD	PC7	Boot Mode	Execution start after RESET#
High	X	Normal Program Boot Mode	Program FLASH reset vector
Low	Low	ROM Boot Mode	Start of Boot Mode ROM
Low	High	USB Boot Mode	Start of USB Boot Mode FLASH

In normal Program boot mode, the **PC7** signal is completely available for program and system use. However, in the two special boot modes, **PC7** must remain fixed throughout the operation of the mode until the subsequent **RESET#** and is not available for general program and system use during these special modes.

The **MD1** and **PC7** signals are weakly pulled high on the SIM225, ensuring that for normal operation the MCU will boot in Normal Program Boot Mode, starting execution at the main RX MCU Program FLASH reset vector. The Program FLASH can be (re)programmed in a variety of ways, including the JTAG port exposed on the [PCB Edge Connector](#) as well as under user program control.

Because the **PC7** and **MD1** signals are available on the [PCB Edge Connector](#), they can be pulled low externally to the SIM forcing the SIM to go into one of the two special boot modes. Consult the Renesas [RX63N/RX631 MCU Hardware Manual](#) for additional boot mode details.

Some SIM225 variants have a DIP switch S4 populated on the PCB. **PC7** and **MD1** are connected to switch positions 1 and 2 respectively. For normal execution, ensure both are in the OFF position. When **MD1/S4. 2** is ON (and because **PC7** is weakly pulled high on the SIM225) the MCU will enter USB Boot Mode on release of **RESET#**.

For those variants without S4 populated, the [SPA100](#) adapter also has this same switch.

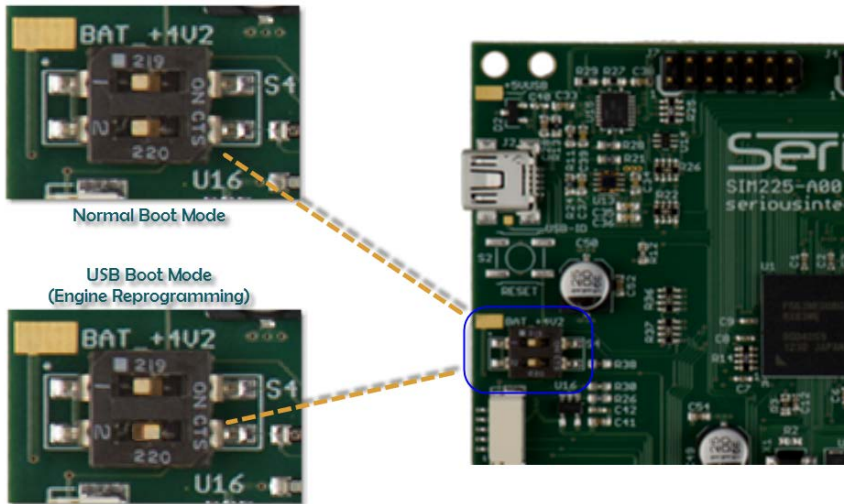

S4.1 and S4.2, when “ON”, are connected directly to GND.

Do not externally drive these signals high while the corresponding switches are ON or you may damage the SIM and/or attached equipment.

In USB Boot Mode, the processor begins execution in the 16KB USB Boot FLASH rather than the normal Program FLASH. **Serious** programs the USB boot area with special firmware designed to function with the [Serious Human Interface™ Platform](#) tools, enabling reprogramming of the [SHIPEngine](#) and Serial FLASH with new GUI cargo files. The algorithm in this firmware is proprietary, and when the SIM225 boots in USB Boot mode the USB port will identify itself as requiring up to 500mA of bus power and having USB Vendor ID **0x25D8** (registered exclusively to **Serious**) and USB Product ID in the **0x0001** to **0x0099** range depending on the version of the protocol contained in the area.

Renesas supplies a standard load for this FLASH area. With the standard Renesas load installed and USB Boot Mode selected, the Renesas firmware reads **P35 (NMI #)** and finds it pulled high, causing the USB device port to tell a connected USB host (such as a PC) that the SIM225 is bus powered and requires up to 500mA of power from the USB port. The USB VID will be **0x045B** (registered exclusively to Renesas) and USB PID of **0x0025**.



To use the full features of the [Serious Human Interface™ Platform](#), you need to preserve the **Serious** firmware in this area. Overwriting and/or re-installing this firmware can only be accomplished with Renesas tools and a JTAG debugger.

GRAPHIC LCD DISPLAY

The LCD display (or “glass”) on the SIM225 is a 4.3” diagonal active area 480x272 TFT with optional 4-wire resistive touch layer. Features include:

Parameter	Typical Value
Type	TFT TRANSMISSIVE
Active Area	95.04x53.86 mm
Pixel Dimensions/Depth	480 x 272
Pixel Color Depth	24-bit connected as 16-bit RBG565
Pixel Pitch	Approx. 128 DPI
On Board Frame Buffer	none
Driver IC	HX8257 or equiv.
Backlight Type	LED
Backlight Luminance (with touch)	300cd/m ²
Backlight Luminance (without touch)	350cd/m ²

The LCD display has no on-glass frame buffer or memory. The MCU is responsible for delivering pixel data at a specific frequency to the LCD display as well as various clock signals otherwise the display will not function correctly and will not display a stable image. No valid image is possible unless the MCU is operating and, under software control, the MCU is delivering pixel and timing data to the LCD display continuously. The LCD display, in absence of a valid signal from the MCU, may automatically enter self-test mode and display various cycling test patterns.

The LCD backlight is enabled when RX P11/BLEN is driven high, which turns on the backlight power boost circuit driving approximately 16.5V to flow to the backlight LEDs on the LCD. This enable signal has a weak pull-down, so the backlight is off until the MCU pin is initialized, including during and directly after system RESET#. Software algorithms can PWM this pin to enable backlight dimming. A PWM driven by a typical 1 KHz clock with 16 PWM steps for a PWM net frequency of 64 Hz is generally sufficient and flicker free with duty cycles from 0 to 100%. In no circumstances should the PWM clock exceed 16 KHz.



The [Serious Human Interface™ Platform](#) has the backlight driver included; setting the platform glass backlight value to 0 to 100% automatically modulates the dimming circuit.

LCD DIRECT DRIVE

Since the LCD display has no on-glass frame buffer, pixel data must be held in memory and streamed continuously to the display hardware. This memory must also be MCU accessible in order for software to “draw” into the frame buffers and transfer images and drawings to the screen.

On the SIM225, the external SDRAM can accommodate one or more full-frame buffers for pixel data and, under software control, algorithms can “draw” into these frame buffers. Delivering the pixel data from bulk frame memory to the LCD normally requires an LCD controller, either as an external hardware circuit or built into the MCU. The RX MCU, without a dedicated LCD controller and with little external circuitry, can deliver pixel data directly from external RAM to the LCD display. This technology is called “Direct Drive” and can deliver excellent user interface experiences at low hardware cost.

For a detailed explanation of Direct Drive operation, consult the Renesas [RX600 Series Direct Drive LCD Demonstration Application Note](#). The concept is straightforward: the RX MCU instructs the SDRAM to deliver the pixel data to the LCD panel at exactly the right frequency (the “dot clock”) so that each line of the screen is “painted” in the correct sequence and at the right time. Typically this painting of the frame is done every 60Hz (16ms) and the paint time is only about

8ms for the frame. Therefore there is a “blank” time that represents about 30-50% of the total 16ms frame time. During the painting time, the MCU software *must not access the SDRAM*, as the MCU access can disrupt the timing of the data delivery to the LCD from the SDRAM and cause visible flickering and shearing on the LCD screen. However, the MCU is free to manipulate and access the SDRAM during the blanking time. Both Renesas and *Serious* software include special “monitor” tasks to lock/unlock tasks needing access to the external RAM without disrupting the LCD operation. Software that uses the external SDRAM needs to be written with the understanding that it is subject to frequent ~8ms delays while the frame is being painted.

The overall advantage of a Direct Drive system is lower cost and circuit complexity. With almost no external components, no graphics controller, no dedicated frame buffers, no dual ported RAM or arbiters, one can create a complete graphic LCD output very inexpensively with excellent visual results.

The LCD panel has two timing modes: VSYNC/HSYNC mode and DEN mode. The SIM225 uses DEN mode which provides better Direct Drive performance and uses less pins and software overhead than VSYNC/HSYNC mode. In DEN mode, the LCD’s VSYNC# and HSYNC# pins are both always pulled inactive, and the DEN signal (when active) indicates when data is being clocked into the LCD panel. DEN is inactive a minimum of 45 clocks between lines, allowing the 480 pixel line previously clocked into the chip to be driven to the screen. DEN is inactive a minimum of 13 lines to signal that the next line is the beginning of a new 272 line frame.



The no-cost SHIPWare software at mySerious.com includes all initialization code, drivers, and utilities to enable Direct Drive operation, including portrait and landscape modes and adjustable frame rates. This software is available after account sign-up and registration of your SIM225 serial number.



The [Serious Human Interface™ Platform](#) software system has fully-integrated and optimized Direct Drive drivers and frame buffer management, making the Direct Drive system transparent to the GUI designer.

TOUCH

Some SIM225 family members include a resistive touch layer bonded to the LCD display. The layer can return an analog voltage in two dimensions to be read by the MCU’s analog-to-digital converters and translated with a software algorithm into a pixel hit position. These four input signals are as follows:

Signal	Description	MCU Port
TOUCH_YB	Y-/YB/YDown	AN000/P40/I RQ8- DS
TOUCH_XR	X+/XR/XRight	AN001/P41/I RQ9- DS
TOUCH_XL	X-/XL/XLeft	AN002/P42
TOUCH_YT	Y+/YU/YTop	AN003/P43

Resistive touch layers are made from a highly resilient Polyethylene Terephthalate (PET) film, and have the advantage of being robust and usable with a stylus, finger, or any blunt object. Unlike typical capacitive touch screens, resistive touch screens do not require the bare finger and can be used with gloves on – important for certain medical, industrial, and automotive applications. They also work well in wet conditions, although appropriate caution must be taken to ensure liquids do not flow onto the SIM225 or other circuitry. *Serious* application note [AN0201: Resistive Touch Bezel Guidelines](#) is a good resource for understanding how to mount a touch screen behind a bezel.

Some chemicals (especially but not limited to Ketone-based products), harsh cleansers, and abrasive cleaning products can discolor and/or damage the PET film. To ensure long usable lifetime, make sure end users are well-informed on how to clean and maintain the touch screen.

One challenge with resistive touch layers is power: applying power through the resistive layer is normally required to sense the change in resistance created when touched. There are two very different modes where power is applied to the panel: (1) basic “is the panel touched?” and (2) actual sensing of the touched position.

BASIC TOUCH TESTING AND WAKE-UP

There are two common places where a simple detection of panel hit is required:

- during CPU sleep modes where a panel touch needs to wake up the CPU and the system, and,
- as a quick test to see if more detailed coordinate reading is needed.

Basic touch testing requires only the ADC pins. The ADC pins, connected through current-limiting resistors to the touch panel, can be configured dynamically by software to be low current outputs or ADC inputs. To do a basic “are we touched?” test on the SIM225, the pins can be configured as follows:

Signal	Mode	State
TOUCH_XL	Output	Drive low via P42
TOUCH_YB	ADC Input	Weakly pulled high

When not touched, the **YB** analog input will read at-or-near the maximum ADC value. The ADC on the RX631/RX63N has 12-bit resolution, so the reading will be at-or-near **0x0FFF**. When the panel is touched, the two layers connect, and the weak pull-up on **YB** is overwhelmed by the strong low on **XL**, causing the ADC value to drop significantly.

In sleep modes, setting an interrupt on **IRQ8-DS** can wake the system when the panel is touched. In this mode the standby power is extremely low – the resistance across the panel planes when not touched is typically 10MΩ.

This simple test can be used in a timer-driven software event to determine if/when a more precise and rigorous full reading of the XY location of the touch screen is required.

TOUCH PANEL COORDINATE READING

Because of current limitations on the MCU pins, 1KΩ resistors are placed in series with the four ADC pins such that when they are used as outputs the current is limited to approximately 1mA. As well, the ADC reading is then limited to the center of the range – the two 1KΩ resistors with the ~500Ω touch plane in between form a voltage divider.

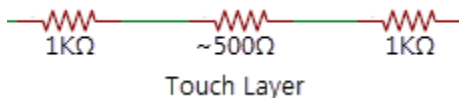

Full reading of the touch coordinates is a more complex task and benefits from a full voltage applied across the planes. Since the touch planes can have resistance as low as 200Ω, up to 16mA is required to drive them – beyond the capability of the RX digital outputs. Therefore the SIM225 has a set of four higher-current output drivers with the following signals directly wired through the drivers from the MCU to the touch panel:

Signal	MCU Name	Enabled State	Touch Signal
DRIVE_YB#	PG0	HI	TOUCH_Y B
DRIVE_XR#	PG1	HI	TOUCH_X R
DRIVE_XL#	PG2	LO	TOUCH_X L
DRIVE_YT#	PG3	LO	TOUCH_Y T

When a signal (e.g. **DRIVE_XR#**) is activated, the corresponding touch signal is strongly driven to the state indicated. This allows a full voltage range across the panel, so 12-bit ADC values from **0x0000** to **0x0FFF** can be read and mapped to the screen coordinates. Touch panel algorithms are beyond the scope of this document, but an Internet search can yield numerous resources in this area.



The no-cost SHIPWare software at mySerious.com includes a full source-code implementation of a touch driver for the SIM225.



The [Serious Human Interface™ Platform](#) has integrated touch drivers and algorithms that automatically map touch coordinates to GUI objects.

POWER SUPPLIES

There are up to three possible sources of system power for the SIM225, depending on the specific variant:

Power Signal	Description	Connectors Where Present
+5V_EXT/+VEXT	External Main Power	<ul style="list-style-type: none"> • Power and Communications Connector • Baseboard Connector • FFC Expansion Connector • PCB Edge Connector • LiPo Battery/Switch Connector
+5V_USBF	USB Device Power	<ul style="list-style-type: none"> • USB Mini-B Device Connector • PCB Edge Connector • Tag-Connect Programming Port • Baseboard Connector
+VBAT_4V2	Lithium Polymer Battery (+) Charging/Power Terminal	<ul style="list-style-type: none"> • LiPo Battery/Switch Connector • Baseboard Connector

On all variants, both the +5V_EXT/+VEXT and +5V_USBF can be supplied simultaneously. On variants with LiPo support, all three signals can be supplied simultaneously.



While all power signals can be supplied simultaneously to the SIM, each signal can only be driven from a single source. **Connecting more than one power source to the same signal simultaneously may damage your SIM or even connected equipment.**

+5V_MAIN ON LIPO VARIANTS

On SIM225 variants with Lithium Polymer Battery support, the Texas Instruments [BQ24030 Dual Input Li-Ion Charger with Dynamic Power Path](#) automatically delivers 3.6-5VDC to the +5V_MAIN main system power line from one or more of the following supplies, in this order: +5V_EXT, +5V_USBF, VBAT_4V2.

The actual usable voltage on the +5V_MAIN signal will range from 3.08 (the SIM225 reset voltage) to 5.0V. When powered by +5V_USBF or +5V_EXT it will be at or near +5V, and when powered by the LiPo battery supply (BAT_+4V2) the +5V_MAIN signal will reflect the current battery voltage (between 3.08 and 4.2V typically).

When operated with the optional Lithium-Ion Polymer (LiPo) battery, the SIM225 may be able to operate for several hours untethered – useful for brownout/blackout avoidance or hand-held operation. The charge rate of the battery is limited to 950mA when charging from the external supply and 500mA when charging from the USB device port.

The SIM225 can be powered exclusively through the [USB Device \(“Function”\) Power](#) which comes into the module through the [USB Mini-B Device Connector](#) and other connectors. This is very handy for debugging and for demos and many readily-available cell-phone USB mini-B chargers can be used. As discussed, this port should supply 500mA to power the board. On the schematics, this supply is denoted +5V_USBF.

In the USB-only powered mode the SIM225’s total power is limited to 500mA: only the extra power not consumed by the SIM225 will be available for battery charging. This may result in long charge times. Turning the SIM225 off (via the PWRDWN# signal) or turning the LCD backlight off will reduce the needed current by the SIM225 and provide up to 500mA of current to charge the battery.

Normally when the SIM225 is incorporated in a production product it is powered from an external power supply, most commonly through the [Power and Communications Connector](#) or the [Baseboard Connector](#). The +5V_EXT signal available on these and other connectors should be supplied with an externally regulated +5VDC supply. Without the optional LiPo battery, an 850mA supply is sufficient. With the battery 1300mA is recommended (850mA + 450mA charging current).

Note that if both +5V_USB and +5V_EXT are present the BQ24030 can pull from both supplies simultaneously, but will always give preference to the external +5V_EXT supply if present. This is called Dynamic Power Path Management (DPPM) and is fully documented in the [BQ24030 data sheet](#).

+VIN_MAIN ON NON-LIPO VARIANTS

On variants without Lithium Ion Polymer battery support, the power supply system is significantly simpler. These variants will be powered by either +5V_USB or +VEXT whichever is **higher** in voltage. This configuration allows, for example, a SIM225 powered in a device via +VEXT to simultaneously have a PC USB port or USB hub connected to the SIM.

The two signals are routed to the +VIN_MAIN signal through two protection diodes. These diodes are low-forward-drop Schottky type and capable of a full 1A continuous current; nevertheless, the +VIN_MAIN signal will typically be 0.3V below the higher of the two input voltages.

MAIN 3.3V REGULATION

Major power consumers, such as the [USB Host](#), [LCD panel backlight power](#), and [audio](#) are all derived from +5V_MAIN/+VIN_MAIN to maximize power conversion efficiency. The rest of the circuitry on the SIM225, including MCU, memories, and LCD display require a +3.3V supply.

The +5V_MAIN/+VIN_MAIN power is converted to 3.3VDC (the +3V3 signal) through a switching power supply at typically 90%+ efficiency. Some variants use the [National/TI LMZ10501 Simple Switcher](#) (capable of delivering up to 1.0A) and others the [Intersil ISL9104](#) (500mA maximum output current).

+3V3 is also delivered to the [Baseboard Connector](#), the [Power and Communications Connector](#), and the [FFC Expansion Connector](#), but is only meant to supply a small amount of power to an attached system. The amount of 3.3VDC power available to these connectors is limited by (a) the total capacity of the regulator and (b) the excess power available on the +3V3 signal after calculating the incoming available power minus that used on the SIM225. The [DC Power Characteristics](#) information in this manual can assist in this calculation: the actual amount available is highly dependent on the specific features used on the specific variant by the system designer and the features enabled in software on that variant.

TURNING SIM225 OFF: THE PWRDWN# SIGNAL

The SIM225, in absence of external connections other than +5_USB or +5V_EXT/+VEXT power, is always powered on. The +3V3 supply can be turned off via the PWRDWN# signal on the [LiPo Battery/Switch Connector](#), the [PCB Edge Connector](#), as well as the [Baseboard Connector](#). PWRDWN# is weakly pulled high on the SIM to deliver the default powered-on behavior. Driving this signal to GND via logic, or connecting it to GND via a simple SPST switch, puts the SIM in power down mode – turning off the 3.3VDC switching regulator and disconnecting power from the MCU and associated circuitry. The audio amplifier, USB host, and LCD backlight booster are also powered off, so when PWRDWN# is asserted the SIM can consume only a few mA. The PWRDWN# signal does not disable LiPo charging: any charging current will still be used even if PWRDWN# is asserted.

LIPO BATTERY

Some SIM225 variants, including the SIM225-A00, include the capability to attach a rechargeable Lithium-Ion Polymer (LiPo) battery. The LiPo battery should be the single cell 3.7V type with two or three wires (power, ground, and optional temperature sensor) and have 500 to 1000mAH capacity.

Most readily available LiPo batteries have 2-wires and include a built-in over-temperature protection circuit, for instance the readily-available 1000mAH [Sparkfun PRT-00339](#). A similar battery is shipped with the SBX200 Prototype Enclosure/Battery Kit for SIM205/225.

 **Lithium batteries, if not properly managed, can overheat and potentially create a fire hazard.** If you use a Lithium Polymer battery with SIM225 you **must** observe sufficient design precautions for Lithium batteries, including carefully following the recommendations in the TI BQ24030 documentation.

LIPO CONNECTION

The SIM225 supports single cell 3.7V LiPo batteries with two or three wires (power, ground, and optional temperature sensor). These three signals are available on both the [LiPo Battery/Switch Connector](#) and [Baseboard Connector](#).

When used with a 2-terminal battery (with internal thermistor and protection circuitry), a 10K Ω resistor must be placed between **BAT_TS** and **GND** for the charging circuit to recognize the battery. Occasionally these types of batteries can (if removed or inserted into a live circuit, for example) go into “protection mode” where they will not accept a charge or deliver power to the attached system. Ensuring power is completely off to the SIM and removing/re-attaching such a battery will normally clear this condition.

 **Do not connect a 3-wire battery and a 10k Ω BAT_TS pull-down resistor simultaneously.** The charging protection circuit may not operate correctly potentially causing the battery to overheat or even self-destruct.

OPTIONAL SWITCH/BATTERY BOARD (SERIOUS P/N SW001)

The Serious SW001 Switch/Battery board is a simple PCB containing an SPST switch, a 2-terminal LiPo battery connector, and the 10K Ω **BAT_TS** pull-down required for 2-terminal batteries. When ordered from Serious as part of the [SBX200 Prototype Enclosure/Battery Kit for SIM205/SIM225](#), the complete accessory kit includes a battery, cable harness, and populated PCB. For schematics and technical documentation on the SW001 and SBX200, see [Additional Information](#).

LIPO CHARGING

The BQ24030 operates both as a battery charger and power path manager, so current can flow to and from the battery depending on the mode. The positive battery terminal is connected to signal **BAT_+4V2** and the negative is connected to system **GND**. When using a 2-wire battery, the **BAT_TS** signal must be grounded through a 10k Ω resistor or the battery will not be charged. When using a 3-wire battery, the **BAT_TS** signal must be connected to the thermal sensor wire of the battery. The [optional Switch/Battery Board \(Serious P/N SW001\)](#) shows a typical circuit for connecting a 2-wire battery.

The maximum charging rate of the battery is maximum 950mA. When both USB and +5V_EXT are powered, the battery charging circuit can draw from both supplies. When only the USB port is connected the total power from the USB port will not exceed 500mA, so whatever power is left over from powering the SIM225 will charge the battery. The amount of time taken to charge the battery is dependent on many factors, but the less power available to the charging circuit the longer it will take to charge the battery. The BQ24030 has a built-in safety timer that is set to expire at approximately 10 hours: if the battery does not reach full charge in this time then charging will suspend and the **BATSTAT** LED will show the error condition (**STAT1#** and **STAT2#** both low).

The most challenging power environment occurs when the SIM225 is solely powered by the USB device port with a 500mA (2500mW) limit. With the backlight fully on and the MCU running, nearly all the power budget is consumed, leaving insufficient power for the audio and USB host subsystem, never mind charging of a LiPo battery. In typical conditions, a battery can be charged – albeit slowly. With the backlight off (or accounting for typical conditions), this leaves some power to charge a battery and with the MCU system off (via [PWRDWN#](#)) nearly all 2500mW are available to charge the battery. However it is clear that, through software, the system designer should avoid using the audio and/or USB host subsystems when only powered by the USB device port. Note that if a partially charged battery is installed in the system, the BQ24030 can augment the USB power with battery power, allowing temporary use of (for example) the audio subsystem.

POWER AND CHARGING STATES AND SIGNALS

The BQ24030 has two status signals (STAT1#, STAT2#) that reflect battery charging status. The BATSTAT bi-color LED, these signals are easily visible:

STAT1#	STAT2#	BATSTAT LED Color	Charging State
ON	ON	Orange	Battery pre-charge
ON	OFF	Red	Battery fast charging
OFF	ON	Green	Battery charge complete
OFF	OFF	Off	Charging fault or asleep

These signals are inverted into MCU port pins so that user-supplied software can monitor their status. In addition, the ACPG# and USBPG# signals supplied by the BQ24030 indicate the presence of sufficient +5V_EXT and +5V_USB# respectively. The combination of signals RX_STAT1, RX_STAT2, ACPG#, and USBPG# provide a complete picture to the MCU of the current sources of power and the charging state of the battery.

Signal	MCU Port
RX_STAT2	P95
RX_STAT1	P94
ACPG#	PG4
USBPG#	PG5

BATTERY LEVEL MEASUREMENT

Measuring the true current charge on a battery is quite challenging. As a balance between cost and accuracy, the SIM225 has a simple method to determine the current voltage on the LiPo battery. A simple high-side switch ([Diodes Inc. AP2280](#)) when enabled (via RX_BATCHCHECK_EN, RX Port P10 set high), delivers a scaled down version of the current battery voltage to the Analog to Digital P46/AN006 input on the RX MCU.

During charging, the voltage will fluctuate up and down. When charging/charged and +5V_EXT and/or +5V_USB# power is present and sufficient, the battery will be under no load and the voltage will read higher than when the battery is supplying the system under load. Based on the status lines (RX_STAT1, RX_STAT2, ACPG#, USBPG#) software can determine the battery state and make appropriate judgements as to the batteries current charge level.

The voltage read by the A-to-D will be scaled by the resistor divider $(1.5K/(1.1K+1.5K)) = \sim 57.69\%$, so a battery voltage near the peak of 4.2V will translate to an A-to-D value of $4.2 * 57.69\% / 3.3V$ (the A-to-D 100% value) * 4096 (the 12 bit A-to-D max count) = 3008. Near the minimum operable battery voltage, the A-to-D will read approximately 2200, so a span of approximately 800 counts is easily calculable for 100% of the usable battery area.

 Note the maximum 1ms turnon time of the high-side switch, so software must wait at least 1ms after turning on the switch (RX_BATCHCHECK_EN high) *before* starting the A-to-D capture cycle.

USB DEVICE (“FUNCTION”) POWER

The SIM225 can be powered from the **+5V_USB** signal present on the [USB Mini-B Device Connector](#), the [Tag-Connect Programming Port](#), the [PCB Edge Connector](#) and the [Baseboard Connector](#). This input is limited to draw a maximum of 500mA, typically from a PC or hub assuming it can supply sufficient current.



Verify the USB hub or PC can supply the [required power](#) to the SIM before connecting.



The USB Mini-B Power input pin (+5V_USB) on various other connectors is directly connected to the USB Mini-B power input: **connecting any of these simultaneously may damage your SIM or even connected equipment such as a PC or USB Hub.**



The 500mA limit on +5_USB is lower than some variants, for example the SIM225-A00 with 0.7W audio amplifier/speaker, require for their complete functionality. Turning on some features without sufficient power may cause a system reset. Ensure sufficient power from the various power supply inputs before turning on these features.

LCD PANEL BACKLIGHT POWER

The [LCD Panel](#) has an array of LEDs supplying the backlight. This LED array requires approximately 16V at up to 800mW to fully light. An [On Semiconductor CAT4139](#) boost regulator and associated circuitry boosts the main power to this voltage, and can be pulse width modulated to vary the brightness (and power required) of the LCD panel.

Backlight power is a significant portion of the SIM’s power consumption. At full brightness, the LCD backlight typically consumes 800mW (50mA @ 16V). Working backwards through the CAT4139 (at about 85% efficiency), this represents a load of approximately 214mA on the +5V_MAIN/+VIN_MAIN supply. Software should carefully manage the backlight to be powered on as infrequently and for as short a time as possible – especially in battery powered systems or when operating from the USB power. Since both of these [conditions are detectable](#), software can drop the brightness to less than 100% when operating from these sources and even further reduce brightness as the software [detects the battery voltage](#) dropping. Another technique is to turn off the backlight completely when the touch panel has not been touched for some duration, for example 30 seconds, and then waking up the backlight when touched again or a condition on the GUI needs attention. This mode often can create a long-term duty cycle of <10% and extend battery life significantly.

The LCD backlight is enabled when RX P11/BLEN is driven high, which turns on the backlight power boost circuit driving approximately 16.5V to flow to the backlight LEDs on the LCD. This enable signal has a weak pull-down, so the backlight is off until the MCU pin is initialized, including during and directly after system **RESET#**. Software algorithms can PWM this pin to enable backlight dimming. A PWM driven by a typical 1 KHz clock with 16 PWM steps for a PWM net frequency of 64 Hz is generally sufficient and flicker free with duty cycles from 0 to 100%. In no circumstances should the PWM clock exceed 16 KHz.



The [Serious Human Interface™ Platform](#) has the backlight driver included; setting the platform glass backlight value to 0 to 100% automatically modulates the dimming circuit.

USB HOST POWER

In SIM225 variants with LiPo support (such as the SIM225-A00), there is no assurance that the main operating power source is +5VDC; often as the battery drains the main supply voltage will drop well below the 5 volts needed to supply the [USB A Host Connector](#). Similarly, on SIM225 variants without LiPo support the input voltage can be as low as 4.00V,

also well below the required USB Host voltage. Note that SIMs without LiPo support, such as the SIM225-A01, can support 3.60V operation as long as the USB boost controller is not enabled in software.



USB devices, when inserted in to the [USB A Host Connector](#), often draw high temporary currents. In the *Serious* lab we have observed simple USB thumb drives drawing a temporary 2A on insertion! Note that with the USB Host feature enabled the minimum voltage on some SIMs, for example the SIM225-A01, is 4.00V to ensure that the large momentary power surge when a USB device is plugged into the [USB A Host Connector](#) does not create an unsupportable temporary voltage drop and cause the SIM to reset. On SIMs with LiPo support and running from a LiPo battery, software should ensure sufficient battery voltage is available to support the substantial draw of a USB device.

Some variants use the [TPS61240 3.5-MHz High Efficiency Step-Up Converter](#) which boosts whatever voltage is present on +5V_MAIN/+VIN_MAIN to 5V for the [USB A Host Connector](#). Other variants use the [TPS2501 Integrated USB Power Switch with Boost Converter](#) for the same purpose.

This supply is enabled by asserting the USB0_VBUSEN signal high on RX MCU port P16, which is connected to the boost converter's EN (enable) signal. The 5V Host power signal is designated on the [schematics](#) as +5V_USBH. The enable is pulled low during reset and remains low (disabled) until the port pin is configured by software explicitly to drive high.

The boost converter delivers 5V at up to 150mA to the USB Host connector, and converts at about 90% efficiency from the incoming power supply. This 150mA is more than sufficient for most USB thumb drives, and some keyboards and mice, but is unlikely to be sufficient for non-powered USB hard drives, printers, etc. Keep this simple calculation in mind: the SIM power plus the power in the USB device attached to the Host connector cannot be greater than the input power.

CLOCK/CALENDAR BATTERY POWER



Some SIM225 variants have a 20mm coin cell holder designed to accommodate a common CR2032-type 3V battery. This is not designed to be a rechargeable battery, nor does any circuit on the SIM225 supply power to charge this battery. The only purpose and connection of this coin cell battery is to provide backup power to the RX MCU's Real Time Clock peripheral to keep the clock/calendar running in the event that all other power sources are removed. Consult the [RX63N/RX631](#) datasheet for exact specifications, but this battery can potentially keep the clock keeping time for several years without replacement. The RTCC circuit in the RX MCU automatically switches to use the coin cell power only when main power is not available, so in a system that normally has main power applied, the coin cell battery is used infrequently. See the [Clock/Calendar](#) section for more information.

On SIM225 variants without the coin cell holder, the MCU's clock/calendar must be re-set after every time power is lost and re-applied to the SIM. In many system architectures, the time/date is available in another portion of the system, and using communications methods the remote time/date can be retrieved at power-up time and programmed in to the MCU's RTCC registers.

MEMORY

SERIAL FLASH

All SIM225 family members include the SST [SST25VF064C](#) serial FLASH, a 64 megabit (8 megabyte) device with 2048 4KByte erasable blocks as well as a built-in 64-bit unique serial ID and 192 bits of OTP ID space.

Some family members contain two devices, a “primary” and “secondary” device. Both are connected via a dedicated SPI port to the MCU to optimize data transfers, especially when images need to be retrieved and delivered directly to the display memory.

The serial FLASH devices are connected to the **RSPI 0** port of the RX MCU:



Description	FLASH Pin	FLASH Name	MCU Signal Name
SPI data MCU→FLASH	5	SDI	PC6/MOSI A
SPI data FLASH→MCU	2	SDO	PC7/MISO A
SPI FLASH clock	6	SCK	PC5/RSPCKA
Primary FLASH slave select	X	CS#	PC4/SSLA0
Secondary FLASH slave select	1	CS#	PC0/SSLA1

See the [SST25VF064C data sheet](#) for hardware specifications and programming details and the Renesas [RX data sheet](#) for information on the SPI master port configuration.

The primary serial FLASH also contains factory-programmed information including the [serial number of the unit as well as variant/version information](#).

SDRAM

The SIM225, depending on the variant, includes either a Micron [MT48LC4M16A2P](#) (8 megabyte) or [MT48LC8M16A2P](#) (16 megabyte) SDRAM with a 16-bit data bus configuration. With the RX MCU operating at 96MHz, the SDRAM can operate at 48MHz. The RX MCU’s built-in SDRAM controller can be configured to enable this memory in random access or burst modes.

The SDRAM, when used with the MCU’s Direct Drive DMA and Timer peripherals, can deliver pixel data directly to the SIM225’s LCD screen. During the delivery of pixel data to the LCD, software in the MCU must be cautious not to access the SDRAM or visible timing artifacts can appear on the screen.

See [Direct Drive](#) for more information.



The SHIPWare source code has SDRAM initialization routines you can examine and use with the SIM225. SHIPWare is available at no cost for registered hardware users on mySerious.com.



[SHIPEngine](#) (the runtime engine of the [Serious Human Interface™ Platform](#)) automatically configures and manages the SDRAM as well as Direct Drive

The following table summarizes the size, speed, and configuration of each family member:

SIM225 Family Member	SDRAM	
	Size	Configuration
-A00	16 Megabytes	1024KB x 16
-A01	16 Megabytes	1024KB x 16
-A02	16 Megabytes	1024KB x 16
-A03	8 Megabytes	512KB x 16
-A04	8 Megabytes	512KB x 16

EEPROM

The SIM225 features a 2Kbit (256 byte) On Semiconductor [CAT34C02](#) EEPROM with software write protection features. The EEPROM is an I2C device on the RX MCU's RIIC1 port and shares an I2C connection with the [PCB Temperature Sensor](#) chip. The EEPROM's address bits are hard coded on the module to 000 yielding a 7-bit I2C address of 0x50 with write command 0xA0 and read command 0xA1.

Signal Name	Description	TS Pin	TS Name	MCU Name
RX_SDA1	I2C Serial Data	1	SDA1	P20/SDA1
RX_SCL1	I2C Serial Clock	2	SCL1	P21/SCL1

Consult the On Semiconductor [CAT34C02 Data Sheet](#) for programming and hardware information.

SERIALIZATION AND VARIANT/VERSION IDENTIFICATION

Beyond the main 8MBytes of FLASH, the SST25VF064C device also has a 256 bit (32 byte) one-time programmable (OTP) region.

The [primary serial FLASH](#) contains factory-programmed information including the serial number of the unit as well as variant/version information. Reading this information at run-time can enable software to dynamically adapt to the specific variant as well as accommodate any software-visible differences between versions of the specific module.



Do not write to the SST25VF064C's OTP region.

This region is reserved for manufacturing and configuration information by *Serious*. Writing to this area may **void your warranty** with Serious and render the module unusable.



SHIPWare and [SHIPEngine](#) have software routines included to read this information on boot and load a data structure for you to easily access these fields from your software. In the case of SHIPWare, this is available from mySerious.com in full source code format.

The 32-bit OTP area in the primary serial FLASH is structured as follows:

Location	Size (Bytes)	Contents
0x00. . 0x07	8	Unique Microchip SST25V064 Serial Number
0x08. . 0x09	2	0x0225 indicates SIM225
0x0A	1	Version of hardware: high nibble is major; low nibble is minor. For example, "0x14" is v1.4
0x0B	1	Variant of hardware: see chart below
0x0C. . 0x0F	4	Unique sequence number of this model/variant
0x10. . 0x17	8	Reserved for custom OEM Serial Number
0x18. . 0x1F	8	Reserved for <i>Serious</i> manufacturing information

Locations 0x08...0x0F, when combined, form the unique *Serious* serial number for the module. All values are stored in **Big Endian** order. Note that the MCU on the SIM is normally operated in Little Endian mode, so byte/word swapping will be required to correctly interpret the data.

The following table maps the Variant ID byte found in the primary SIM25VF064C's OTP area at location 0x0B to the SIM225 variant name.

Variant ID Byte	SIM225 Variant Name
0x00	-A00
0x01	-A01
0x02	-A02
0x03	-A03
0x04	-A04
0x99	Renesas YLCDRX63N
0xFF	Invalid/Unknown
All others	Reserved

UNIVERSAL SERIAL BUS (USB)

All SIM225 variants have a single USB 2.0 Full Speed (12Mbit/s) device (or “function”) capability, though not all variants have the associated mini-B connector. The USB Device signals are also available on other connectors, including [the PCB Edge Connector](#) and the Baseboard Connector (when present).

Some SIM225 variants also have a USB 2.0 Full Speed embedded host “A” connector and associated capability for (typically) support of USB thumb drives, keyboards, mice, etc.

The following chart lists the current SIM225 variants and the USB options:

SIM225 Variant	USB Device		USB Embedded Host	
	Circuitry	Mini-B Connector	Circuitry	A Connector
-A00	✓	✓	✓	✓
-A01	✓	✓	✓	✓
-A02	✓	✓	✓	✓
-A03	✓			
-A04	✓			

DEVICE IDS

USB devices are uniquely identified by a Vendor ID (“VID”) and Product ID (“PID”). VIDs are assigned under license by the [USB Implementers Forum](#). The *Serious* VID is **0x25D8**.



You may use the *Serious* VID **only with the [Serious Human Interface™ Platform](#) by using [SHIPEngine](#) on the module**. If you wish to program your own software for the SIM, you **must** obtain your own VID from the [USB Implementers Forum](#).

The [SHIPEngine](#) software identifies all SIM225 family members as **VID/PID 0x25D8/0x0225**.



Many Serious Integrated Modules (SIMs) starting in late 2012 will come with a factory-installed boot loader program. This boot loader, when entering [boot loader mode](#), will identify all SIMs (all families) with **VID 0x25D8** and **PIDs** in the **0x0001...0x00FF** range.

This boot loader is available for re-installation; see [Additional Information](#).

SOFTWARE

Renesas provides extensive documentation of the [RX63N/RX631](#) MCU as well as example software: consult the Renesas [USB Driver software website](#).



Vendors such as [Micrium](#) and [Segger](#) provide complete USB stacks pre-ported to the RX MCU.

DEVICE PORT USB1

The [RX63N/RX631](#) MCU used on the SIM225 has a USB 2.0 Full Speed (12Mbit/s) device (or “function”) port. All SIM225 family members (aka “variants”) have the USB device port *circuitry* connected to this port (USB1). From a data-connectivity perspective, this port is commonly plugged into a PC and, depending on user-supplied software, can act like any number of PC peripherals such as a serial port.



[SHIPEngine](#) contains built-in USB device stacks and protocols that allow the SIM225 to communicate directly with [SHIPTide](#) (the rapid GUI development IDE) so GUIs can be downloaded quickly and simply from the PC to the SIM.

MINI-B CONNECTOR

While all variants have the USB Device capability, only some variants have the USB Mini-B connector. The PCB Edge connector (all variants) has these signals and can be accessed there. An SPA100 programming adapter from Serious is an inexpensive small hardware adapter that can connect to the PCB edge connector and expose the USB port via a Mini-B connector. For more information see [USB Mini-B Device Connector](#).

DEVICE POWER

The SIM225 can be powered via the USB device port, for example, from a powered hub or USB power adapter. This signal is marked as **+5_USBF** on the schematics. Regardless of the +5_USBF source ([USB Mini-B Device Connector](#), [PCB Edge Connector](#), etc.), the SIM225 will pull no more than 500mA from this signal, and may require the full 500mA. Most PCs (including modern laptops) as well as powered hubs can supply this power. Be sure to check the power capability of the host device you are attempting to use.



+5_USBF is **directly** connected to the +5_USBF pins on several connectors, including the [USB Mini-B Device Connector](#), the [Tag Connect Connector](#), the [PCB Edge Connector](#) and the [Baseboard Connector](#).

Do not simultaneously connect power to more than one of these pins or devices attached to these pins, including the SIM, may be damaged.

The USB device power connection is also source protected from the external power input (+5_EXT signal), so both the USB port and the external power port can be simultaneously connected. On variants without LiPo capability whichever source has a higher voltage will power the module. On units with LiPo capability (regardless of whether or not a LiPo battery is attached) current may be sourced from both the +5_USBF and +5_EXT connections. See [Power Supplies](#) for more details.



Some features of the SIM225 **should not be activated from software** when powered solely from the 500mA maximum available on the USB Device port. High-power features such as the [Speaker/Amplifier](#) and USB [Embedded Host Port](#) often require too much current for this supply alone. These features may only be accessible when more power is available, for example when used with an external [LiPo battery](#) or when sufficient power is supplied from +5_EXT.

EMBEDDED HOST PORT USB0

The USB Host port on the SIM225 can (with the appropriate user-supplied software) drive a USB device such as a printer, WiFi module, keyboard, or FLASH thumb drive. This port can supply up to 150mA of power and has built-in current limiting and over-stress shutdown capabilities.



You must ascertain the total power budget available to the unit (for instance, 500mA total from the USB device port) and subtract the requirements of the SIM225 itself and any battery charging: the remainder, up to 150mA, is available to the USB host connector.

The 5VDC power to the USB A host connector is enabled when the RX MCU's P16/USB0_VBUSEN signal is set high; this signal has a pull-down resistor to ensure at (and after) RESET this power is disabled until software explicitly activates it.

Even if the module is operating solely from a 3.7VDC LiPo battery (available on some variants), the 5VDC USB host port can be used if sufficient power is available: see [Power Supplies: USB Host Power](#) for details.

AUDIO

SIM225 variants can support several audio options:

- a piezoelectric sounder for alarm and notification “beeps”
- a small speaker/amplifier for demonstration and low volume audio waveforms
- stereo audio DAC outputs for off-module amplification and delivery of audio waveforms



SHIPEngine has built-in audio support. With only a few lines of code you can, for instance, deliver an ADPCM .wav file to the DAO audio and speaker output.



Vendors such as [Micrium](#) and [Segger](#) provide software solutions that can deliver audio waveforms to this output. Renesas also has example code for this feature.

PIEZO SOUNDER

Some SIM225 variants include a piezoelectric sounder suitable for notifications, alarms, etc.

The PJ3/BUZVOL signal controls the buzzer drive power, with the signal low and high representing “normal” and “full” volume power respectively. The full volume mode does require slightly more power from the power supply but has a noticeably louder range. Most applications using the sounder will turn on the PJ3/BUZVOL signal for full volume range.

The sounder is activated by applying a frequency to the P86/BUZ signal. The RX MCU has a PWM peripheral able to drive this signal, so software will typically be written to drive the sounder at a given frequency with 50% duty cycle for full volume output. The duty cycle can be reduced to lower the volume.

The sounder's resonant frequency is centered at 2400 Hz. Waveforms at this frequency will generate the loudest perceived sound.

DAC OUTPUTS

The RX MCU has dual 10-bit DACs that can be used to generate a 3.3V P-P signal suitable for further amplification, scaling, and filtering as an audio output source. These two signals, typically used to generate left and right stereo audio waveforms, are called DAO and DA1.

The SIM225 exposes DAO, on the [Power and Communications Connector](#) as well as the [24-pin FFC Connector](#), and the [Baseboard Connector](#) has both DAO (RX_AUDI O_OUT) and DA1 (RX_GPI O2) allowing for mono, stereo, or dual mono audio output.

SPEAKER/AMPLIFIER

The SIM225 includes an on-module high quality [PUI 1308MS-R speaker](#) driven by a small but efficient [Analog Devices SSM2301 750mW Class D Audio Amplifier](#). Driven by the RX MCU's on-chip Digital to Analog converter (RX_AUDI O_OUT: DAO/P03/C2) and enabled via the RX_AUDI O_EN# signal (RX Port P02/B1), the speaker can drive reasonable quality and volume audio output for user prompting and feedback under software control. An appropriate cabinet/case design around the SIM225 is important in forming an audio cavity to improve volume and bass response.



When solely powered by [USB Device Power \(+5 USBF\)](#) there is insufficient power to drive the audio speaker/amplifier subsystem: turning on this subsystem without sufficient power will typically cause a reset as the USB host (PC or hub) voltage drops due to excessive load.

TEMPERATURE SENSING

MCU ON-CHIP TEMPERATURE SENSOR

The SIM225's MCU contains an on-chip temperature sensor, readable by the on-chip 12 bit ADC with a typical accuracy of +/- 1%. This sensor may be suitable for keeping track of general system temperature, but is not an accurate ambient air temperature sensor. Air temperature sensors generally require separation from the circuit board to isolate them from heating sources on the PCB, especially the LCD backlight. As a result, the RX MCU's temperature sensor will often read a few degrees above that of the ambient temperature. In addition, software-managed calibration may be required before use.

See the [RX63N/RX631](#) datasheet for more hardware specifications and programming information.

PCB TEMPERATURE SENSOR

Some SIM225 variants also contain an [On Semiconductor NCT75](#) for measuring the system (board) temperature. This sensor is excellent for keeping track of general system temperature, but is not an ambient air temperature sensor: accurate air temperature sensors require separation from the circuit board in order to isolate the sensor from heating sources on the board. As a result, the NCT75 will typically read a few degrees above that of the ambient temperature.

The high level specifications for this device are:

Parameter	Value
Accuracy	
Typical @ 25°C	±0.5°C
Worst Case @ 0°C to +70°C	±1.0°C
Supply Current	
Typical	440uA
Max	800uA
Shutdown Typical	3uA

The sensor supports 12 bit resolution readings in approximately 50ms.

The temperature sensor is an I2C device on the RX MCU's IIC1 port and shares an I2C connection with the [EEPROM](#) chip. The temperature sensor A[2: 0] address bits are hard coded on the module to 000 which results in an I2C address A[6: 0] of 0x48.

Signal Name	Description	TS Pin	TS Name	MCU Name
RX_SDA1	I2C Serial Data	1	SDA1	P20/SDA1
RX_SCL1	I2C Serial Clock	2	SCL1	P21/SCL1
TEMP_ALERT	Temperature Alert Signal	3	ALERT	P45/IRQ13

The sensor's TEMP_ALERT signal is connected to MCU pin P45/IRQ13, and the TEMP_ALERT signal can be programmed on the sensor to signal the MCU when a programmed temperature limit has been exceeded.

See [the datasheet](#) for more hardware specifications and programming information.

CLOCKS, OSCILLATORS, AND TIME KEEPING

The following terms are important to understand theory of operation described herein:

- Clock:** A square-wave logic-level periodic signal (not a clock as in a timekeeping clock of time/date/minutes/hours, etc.)
- Oscillator:** A crystal or resonating oscillator circuit that creates a fixed-frequency sine wave used in a specific circuit to create a clock signal
- RTCC:** A real time clock/calendar which keeps track of the correct time/date as set by the end user or some other means.

There are many producers and consumers of stable clock signals (or "clocks") on the SIM225.

All clocks – including, for instance, the 96MHz CPU core clock, the 12MHz USB clock, and a 9,600baud serial port clock – can be traced back to an originating oscillator source somewhere. The two main oscillators/clocks in the SIM225 are:

- 1) Some variants have a 32.768 KHz tuning fork crystal attached to the RTCC input on the MCU. For modules with battery-backed RTCC capability, this oscillator can continue to operate without module main power applied if the coin cell is inserted.

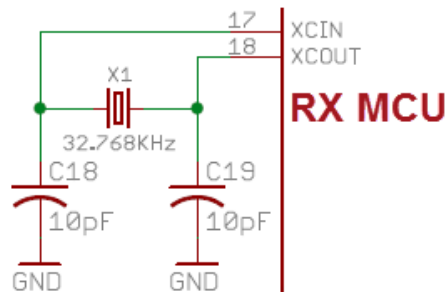

The relatively accurate 12MHz clock to the MCU, which is multiplied and divided in a variety of ways inside the MCU to generate the 96MHz the MCU runs at as well as all the different peripheral clocks.

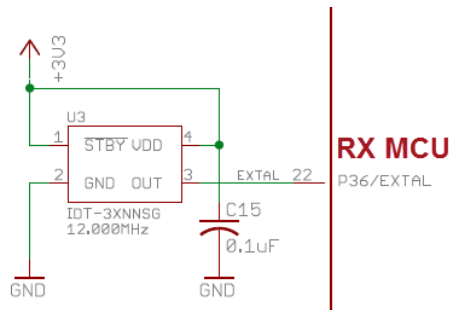

CPU AND PERIPHERAL CLOCKS

The SIM225 uses the external 12MHz oscillator module attached to the MCU’s input clock circuit as the primary source for all non-timekeeping clocks in the system.

The RX MCU, like all modern MCUs, has sophisticated internal clock management circuitry which takes a few input clock frequencies and delivers a plethora of derivative clocks; some higher frequency, some lower. For instance, the RX MCU can take a single 12MHz input clock and create derivative clocks such as the core 96MHz CPU clock as well as various peripheral clocks including 48MHz required for the 12mbps USB ports, 9600 baud for a UART serial port, 48MHz for the SRAM bus, etc. While the RX63x MCU family used on the SIM225 can operate up to 100MHz, on the SIM225 it should typically be programmed to operate at 96MHz so that all the other peripherals can divide down properly from that top frequency. The complexity and capabilities of the RX family clock system are beyond the scope of this guide: consult the Renesas documentation for a complete description.

MCU ON-CHIP BATTERY BACKED REAL-TIME CLOCK/CALENDAR

Time keeping (i.e. year/month/day/hour/etc.) can be performed using the RX MCU’s internal Real Time Clock/Calendar peripheral. This peripheral can be driven from the 32.768 KHz tuning fork crystal input (if populated on the module variant) or derived from the 12MHz main oscillator.

The RTCC peripheral must be configured (via software and registers) to be enabled and use the correct clock input.

RTCC BATTERY BACKUP

The RX63x MCU has several power inputs, including a “main” 3.3V power input connected to the main module power. The RTCC is normally powered from the main module power.

Some SIM225 variants have a [clock/calendar coin cell battery holder](#) designed to accommodate an industry standard CR2032 coin cell battery. This battery is connected to the RTCC battery backup voltage input on the RX63x MCU. When 3.3V main power fails, the RX MCU switches over automatically to keep the RTCC running from the coin cell.

With a good quality battery, the clock/calendar could run for up to several years without replacement. Consult the [RX MCU](#) data sheet or [Contact Renesas](#) for detailed assistance in calculating battery life expectations in your specific end-usage model.

If the variant does not have this capability, the RTCC contents will be lost when main power is removed. In many installation configurations the current date/time will be retrieved (and SIM RTCC initialized accordingly) from an attached system that has a battery backed or network-updated time source.

RTCC REAL TIME CLOCK TEMPERATURE COMPENSATION

Like all timekeeping devices, the RTCC will drift over time. Few timepieces are perfectly accurate! The drift and resulting inaccuracy are determined by the accuracy of the 32.768 KHz oscillator. Temperature variance is the most common culprit: crystals have slight variations in frequency over temperature.

The RX63x MCU Family RTC peripheral has a Time Error Adjustment Register (RADJ) which, when combined with the SIM225's on-MCU and/or on-PCB temperature sensor, could be used with custom software to improve the accuracy over temperature of the RTCC. [Contact Renesas](#) for assistance if your application requires this level of precision in your specific end-usage model.

USER PUSHBUTTON SWITCH AND LEDs

Some SIM225 variants have a single end-user-friendly pushbutton switch on the display-side of the module near the LCD panel. The switch is connected to an MCU input that is both a general purpose input and also an interrupt input that can wake the MCU from various sleep modes. A front panel captive button or plunger can be positioned to actuate this switch. There is no requirement for an end-system to use this switch; the enclosure may cover it completely and render it inaccessible if desired.

Some SIM225 variants have two bi-color red-green LEDs placed on front of the display-side of the module. A bi-color LED is actually two independent LEDs in one package: the LED on the SIM225 has red and green LEDs that, when both are on, have an amber hue. Typically, a plastic or metal front panel enclosure will expose this LED through a plastic light pipe; for example, the [BiVar PLP1-125-F](#). There is no requirement for an end-system to expose this LED. The enclosure may cover it completely and render it un-viewable if desired.

Signal	Description	MCU Port
SW1#	Switch Input (active low)	P07
LEDRR	LED Right Red	P90/LEDO
LEDRG	LED Right Green	P91/LED1
LEDLR	LED Left Red	P92/LED2
LEDLG	LED Left Green	P93/LED3

CONNECTORS

BASEBOARD CONNECTOR

While the 7-pin [Power and Communications Connector](#) is the most common way to connect an external system to the SIM225 (and most common across various sizes and families of SIMs), the SIM225 Baseboard Connector is one of the most flexible off-module connectors available and exposes many more signals. Often a simple 2-layer PCB daughter-card will be attached to the SIM225 using this connector to adapt the SIM225 to a particular system environment. For example, at *Serious* we developed for a customer an RS485 transceiver plus 12-30VDC switching power supply daughter-card that could connect to a powered RS485 network cable driven by a Programmable Logic Controller (PLC). The signals available on the Baseboard Connector are very reconfigurable, supporting I2C, SPI, CAN, high speed serial, USB device, as well as GPIO, battery power, system reset, and more.

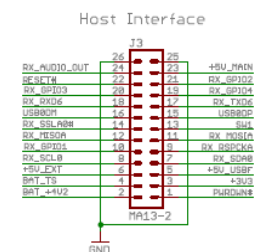

Many of the indicated functions require both the PnmPFS and PORTm.PMR registers to be correctly configured. Careful examination of the [RX MCU Hardware Manual](#) yields the ability to reconfigure many of these pins to these functions as well as other modes, including GPIO.

Signal	Description	Pin	MCU Name
PWRDWN#	When connected/driven low, puts the SIM205 into power down mode. See Turning SIM205 Off: The PWRDWN# Signal .	1	-
BAT_+4V2	If a Lithium Polymer battery is connected VBAT_+4V2 must be connected to the positive (+) terminal of the battery. See Battery Selection, Connection, and Charging .	2	-
+3V3	Regulated 3.3V output. See 3.3V Main Power Regulator	3	-
BAT_TS	If a Lithium Polymer battery is connected BAT_TS must be connected to the thermistor terminal of the battery. See Battery Selection, Connection, and Charging .	4	-
+5V_USBF	USB Device ("Function") Power .	5	-
+5V_EXT/+VEXT	External SIM power input. See Power Sources .	6	-
RX_SDA0	GPIO, I2C2 Data, or UART2 TxD	7	P13/SSDA2/TXD2
RX_SCL0	GPIO, I2C2 Clock, or UART2 RxD	8	P12/SSCL2/RXD2
RX_RSPCKB	RX MCU SPI RSPI 1 Clock	9	P27/RSPCKB
RX_GPI01	RX MCU GPIO: Analog to Digital Input and Interrupt capable.	10	P44/AN004/IRQ12
RX_MOSIB	RX MCU RSPI 0 Master Out Slave In	11	P26/MOSIB
RX_MISOB	RX MCU RSPI 0 Master In Slave Out	12	P30/MISOB
SW1#	RX MCU GPIO P0.7 connected to User Switch	13	P07/IRQ15
RX_SSLB0#	RX MCU RSPI 1 Slave Select	14	P31/SSLB0#
USB1DP	USB Device Data+. Also on PCB Edge Connector, Tag-Connect Programming Port, FFC Expansion Connector .	15	USB1DP
USB1DM	USB Device Data-. Also on PCB Edge Connector, Tag-Connect Programming Port, FFC Expansion Connector .	16	USB1DM
RX_TXD6	GPIO or RX UART6 Tx	17	P00/TXD6
RX_RXD6	GPIO or RX UART6 Rx	18	P01/RXD6
RX_GPI04	GPIO or CAN0 Tx	19	P32/CTX0
RX_GPI03	GPIO or CAN0 Rx	20	P33/CRX0
RX_GPI02	GPIO or Digital To Analog Port 1. See Audio: DAC Outputs .	21	P05/DA1
RESET#	System Reset (wired-or with Reset switch)	22	RESET#
+5V_MAIN +VIN_MAIN	Main on-module voltage prior to regulators. See Power Sources .	23	
RX_AUDI0_OUT	GPIO or Digital To Analog Port 0. See Audio: DAC Outputs .	24	P03/DAO
GND	Ground	25	
GND	Ground	26	

There is no legacy full-level RS232 port on the SIM225 however a simple and inexpensive adaptor (such as the [CircuitMonkey.com USB-Serial TTL Adapter](#)) can be easily attached to the one of the Baseboard Connector's UARTs to enable full serial-over-USB communications to a PC. Alternatively, a common RS232 chip (like the venerable [MAX232](#) or similar) can boost the 3.3V UART levels to traditional RS232 voltages.

PCB EDGE CONNECTOR

The SIM225 and many other new Serious Integrated Modules contain a special PCB Edge Connector primarily used for software development, SIM manufacturing, and volume (re)programming. It features the full signals of the JTAG port, USB device port, primary UART, as well as power in/out connections.

Many applications only use the first 20 pins with the [Samtec MEC6-110-02-L-D-RA1-TR](#) mating connector. These same 20 pins are available on other SIMs, including the SIM110. Some applications will use all the pins with the 40-pin [Samtec MEC6-120-02-L-D-RA1-TR](#) mating connector. Not all SIMs have these extra pins.



The PCB Edge Connector is not polarized or keyed. **Connecting it backwards may damage your SIM and/or connected equipment.**

The PCB Edge Connector is designed as a unified connector across a variety of SIM families, including those based on the Renesas [RX62N/RX621](#) as well as [RX63N/RX631](#) MCUs. These MCUs have a variety of I/O multiplexers allowing one of numerous different peripheral functions to map to a given I/O pin. Consult the respective hardware manuals for the complete list of options. The following chart shows the intended primary usage of the basic 20-pin version of the PCB Edge Connector:

Signal	Description	Pin	RX631/63N MCU Name	RX621/62N MCU Name
+3V3	Regulated 3.3V output from module; see Power Supplies for current limitations and information.	1		
RESET#	System RESET# input and/or output; weakly pulled high on the module.	2		RES#
+5V_USBF	Same as the +5V incoming power pin on USB Device Connector. Do not connect power simultaneously to both of these pins. See USB Device ("Function") Power .	3		
PC7/MISOA	PC7 has special a special boot-mode function when RESET# is released on the RX63N/631	4	PC7	MDO
MD/FINED	MCU enters USB boot mode when pulled low at RESET#	5	MD/FINED	MD1
PC7/MISOA	SPI Data Master In/Slave Out	6		PC7/MISOA
TCK/FINEC	Debug/Programming Pin	7	TCK/FINEC	
PC5/RSPCKA	SPI Clock	8		PC5/RSPCKA
EMLE	Debug/Programming Pin	9		EMLE
PC6/MOSIA	SPI Data Master Out/Slave In	10		PC6/MOSIA
TRST#	Debug/Programming Pin	11	TRST#	
PC4/SSLA0	SPI Slave Select (active low)	12		PC4/SSLA0
TDO	Debug/Programming Pin	13	TDO	
USBODM	USB Device Data+. Connected to USB Mini-B	14	USBODM	USB1DM
TMS	Debug/Programming Pin	15	TMS	
USBODP	USB Device Data+. Connected to USB Mini-B	16	USBODP	USB1DP
TDI	Debug/Programming Pin	17	TDI	
P20/SDA1	I2C Data	18		
GND	Ground	19		GND
P21/SCL1	I2C Clock	20	P12/SCL1/RXD2	P12/SCL0/RXD2

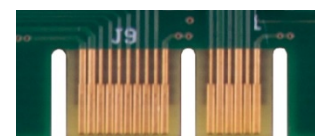
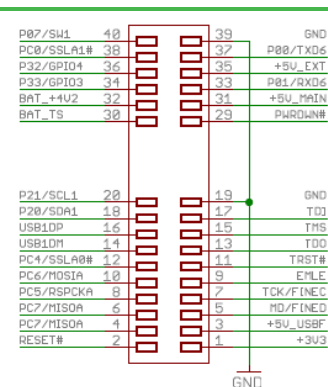

The [SPA100 Serious Programming Adapter SPA100](#) is designed for off-the-shelf access to this port, and the SPA100 may be required to reprogram SIM225 variants that do not have the [JTAG Connector](#) and/or [USB Mini-B Device Connector](#).

Some SIM225 variants have the extended version of the PCB Edge Connector exposing additional signals:

Signal	Description	Pin	RX631/63N MCU Name	RX621/62N MCU Name
PWRDWN#	This low-current input signal powers off the SIM225's main regulator(s) when pulled low. Weakly pulled high on-module.	29	-	-
BAT_TS	The LiPo battery thermistor input on SIM225's with LiPo support .	30	-	-
+5V_MAIN +VIN_MAIN	Main on-module voltage prior to regulators. See Power Sources .	31	-	-
BAT_+4V2	The "+" LiPo battery terminal on SIM225's with LiPo support .	32	-	-
P01/RXD6	General purpose I/O and optional UART Rx.	33	P01/RXD6	-
P33/GPI03	General purpose I/O	34	P33/GPI03	-
+5V_EXT/+VEXT	External SIM power input. See Power Sources .	35	-	-
P32/GPI04	General purpose I/O	36	P32/GPI04	-
P00/TXD6	General purpose I/O and optional UART Tx.	37	P00/TXD6	-
PC0/SSLA1#	PC0/SPI Slave Select 1	38	PC0/SSLA1#	-
GND	Ground	39	GND	-
P07/SW1	User Switch	40	P07	-

You can design your own adapter with the 40-pin [Samtec MEC6-120-02-L-D-RA1-TR](#) mating connector. There is no Samtec standard mating connector to use pins 29-40 without also connecting to pins 1-20.

SERIOUS PROGRAMMING ADAPTER SPA100

The [Serious Programming Adapter SPA100](#) is an inexpensive programming/USB for use with the SIM225, SIM110 and other Serious Integrated Modules with the [Connector](#). Features include:

- [Samtec MEC6-110-02-L-D-RA1-TR](#) 20-position mating connector
- Standard Renesas 14 pin JTAG header allowing simple connection to various programmers, including the [Renesas E1](#) and the [Segger J-Link family](#). A full the E1 interface can be found in the Renesas [E1/E20 Emulator Additional Notes for Application Note](#)
- USB Mini-B connector exposing the USB Device of the target SIM (especially useful for the circuit but no connector, such as the SIM225-A03 and -A04)
- Power jumpers so the USB Mini-B connector can supply (or not) the power to the unit
- DIP Switch to put the SIM225 in Renesas USB Boot Mode
- Low cost



cable adapter
[PCB Edge](#)

debuggers and
description of
[RX600 Family](#)

SIMs that have



The PCB Edge Connector is not polarized or keyed. **Connecting it backwards may damage your SIM.**



The PCB Edge Connector is not hard gold plated to keep SIM costs affordable. It is therefore designed for limited insertion/removals and excessive insertions/removals can degrade signal integrity and connectivity.

When connecting a SPA to a SIM, make absolutely sure you do not get the two reversed/upside down. Many of these are not keyed/polarized and connecting the SPA backwards can damage your SIM, SPA, or USB hub. Look for the white silk screen "spikes" and make sure they're aligned. Here's an example of the SPA100 plugged into a SIM:

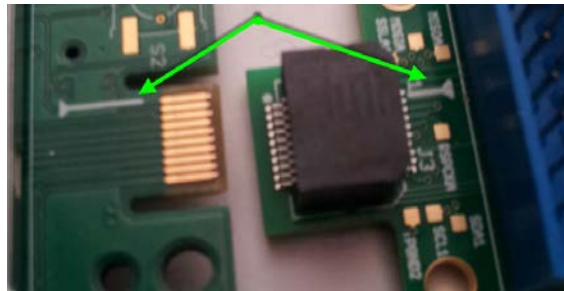

Unless the appropriate jumper on SPA100 is removed, the USB Mini-B Power input pin on the SPA100 is directly connected to the USB Mini-B power input: **connecting both simultaneously may damage your SIM or even your PC/Hub powering the SIM/SPA100.**



The PCB Edge Connector is not designed for live power insertion/removal. Ensure the power to the SIM is off when connecting or disconnecting from this port to **avoid damage your SIM or connected equipment.**

Consult the [SPA100](#) documentation for more details and recommended usage guidelines.

TAG-CONNECT PROGRAMMING PORT

[Tag-Connect](#) is a rapid-connection system designed for in-situ reprogramming or connectivity. It adds no cost to the target hardware and is implemented on the PCB through a simple set of landing pads and guide holes. The SIM225 has a 10 pin pad-set designed to accommodate the [TC2050-IDC-NL](#) cable or similar.



In some variants, the SIM225 will not have the Mini-B connector populated. In some customer designed systems incorporating a SIM, system access to the Mini-B connector may be obstructed. J2 allows rapid connection to the SIM for maintenance/servicing.

Signal Name	Description	Pin	RX631/63N MCU Pin Name	RX621/62N MCU Pin Name
+D_USBF	USB Device Data+. Connected to USB Mini-B.	1	USB1DP	USBODP
-D_USBF	USB Device Data-. Connected to USB Mini-B.	2	USB1DM	USBODM
TDO	*TxD UART Transmit 3.3V	3		TxD1
TDI	*RxD UART Receive 3.3V	4		RxD1
BOOTMODE1	PC7 (RX63X) and MD1 (RX62X) special boot-mode function pins when RESET# is released	5	PC7	MD1
+5V_USBF	Same as the +5V incoming power pin on USB Device Connector. Do not connect power simultaneously to both of these pins. See USB Device ("Function") Power .	6		
BOOTMODE0	MCU enters USB boot mode when pulled low at RES#.	7	MD/FINED	MDO
RESET#	System Reset input and/or output; pulled high on the module.	8		RES#
GND	Ground	9		GND
GND	Ground	10		GND



Upcoming versions of SHIP may support [SHIPEngine](#) and cargo uploading via the USB Device port, including (with the correct hardware adapter) via the Tag-Connect connector. A maintenance person (for example) could, with a laptop and USB<>Tag-Connect cable, hold the connector to the pads and upgrade the GUI and [SHIPEngine](#) on the unit in a few seconds.

At this time, there is no standard **Serious** cable for this port; contact **Serious** for assistance in using this connector.

POWER AND COMMUNICATIONS CONNECTOR

The most common way a SIM225 is connected to another system is via the 7-pin wire-to-board connector.

All SIM225 variants have this connector as a JST [SM07B-GHS-TB\(LF\)\(SN\)](#). When designing your own wire harness, specify mating housing JST GHR-07V-S with 7 JST SSSL-002T-P0.2 crimp pins supporting wire gauges from 26 to 30 AWG. [JST America](#) offers a sample service for wire harnesses, and custom wire harness manufacturers such as [TLC Electronics](#) can assist in small to large volume harness development and production.

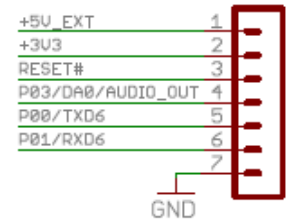

The JST connector is also present on many other SIMs, including the SIM110 family and SIM535 family. A wire harness from an external system to this connector type can support a scalable front panel connection from 3.0" to 7.0"! However, this connector is limited to 1A maximum per pin and -25C operational limits, so some SIM535 and larger LCD SIMs exceed the power capability of the JST connector and some SIMs support operation below -25C. For this reason, some newer SIM225 variants also have a 7-pin [Molex 874380743](#) wired in parallel with the JST. This connector is capable of 3A per pin and -40C operation.

In all cases, check the SIM [DC Power Specifications](#) of the SIM to ensure the gauge of wire selected is sufficient for the power required.

Signal Name	Description	Pin
+5V_EXT/+VEXT	External SIM power input. See Power Sources .	1
+3V3	Regulated +3.3VDC output from module; see Power Supplies .	2
RESET#	System RESET# input and/or output; pulled high on the module.	3
P03/DA0 P47/AN7/AAN7	With SHIPEngine , this functions as a 3.3V p-p audio output DAC. It is multi-connected to an analog input port, a DAC port, and can also be used as GPIO with custom software.	4
P00/TXD6	With SHIPEngine , this is the primary UART0 Tx pin (3.3V). Custom software may be able reconfigure this pin in numerous ways.	5
P01/RXD6	With SHIPEngine , this is the primary UART0 Rx pin (3.3V). Custom software may be able reconfigure this pin in numerous ways.	6
GND	Ground	7



Several signals on this connector are directly connected to signals on other connectors, including +3V3, RESET#, +5V_EXT/+VEXT. **Ensure that common signal connections are appropriate or you may damage your SIM or connected equipment.**



[SHIPEngine](#) uses the primary UART0 provided on pins 4 and 5 of J5 as the main communications mechanism for communicating with external systems.

There is no legacy full-level RS232 port on the SIM225. However, a simple and very inexpensive adaptor (such as the [CircuitMonkey.com USB-Serial TTL Adapter](#)) can be easily attached to primary 3.3V UART Tx/Rx signals to enable full serial-over-USB communications to a PC. Alternatively, a common RS232 chip (like the venerable [MAX232](#) or similar) can boost the 3.3V UART levels to traditional RS232 voltages.

LIPO BATTERY/SWITCH CONNECTOR

On variants with LiPo support, such as the SIM225-A00, the LiPo battery can be connected via the Battery/Switch Connector:

Signal	Description	Pin
BAT_TS	Battery Temperature Sense	1
PWRDWN#	Driving/connecting to GND puts SIM225 in power-down. Weakly pulled high to +5V_MAIN on-module.	2
GND	Ground and Battery (-) connection	3
BAT_+4V2	Battery (+) connection	4
RESET#	Wired-or with Reset Switch	5

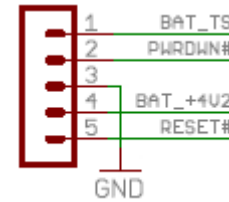

The connector is a 5-pin [JST GH Series connector](#), designed for a mating connector [JST GHR-05V-S](#). The 5 signals are also available on the [Baseboard Connector](#), and allow direct battery connection or a cable to an external PCB with battery connection, system on/off switch and/or reset switch. [As described above](#), the PWRDWN# signal can be connected or driven low to turn off the SIM.

USB MINI-B DEVICE CONNECTOR

All SIM225 variants have the USB device (or “function” in USB nomenclature) circuitry and connected to the RX MCU’s USB0 port. However, only some SIM225 variants have Mini-B connector present. The standard USB device signals are always present on the [Connector](#) and [Tag-Connect Programming Port](#) and will also be present on the [Connector](#) [FFC Expansion Connector](#) if populated on the variant.

The USB port is a USB 2.0 Full Speed (12 mbps max) port. The USB Vendor ID (VID) and (PID) are software dependent. See www.seriousintegrated.com/docs for information VID/PID combinations.

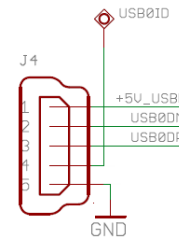

populated the USB [PCB Edge Baseboard](#)

Product ID on *Serious*



Verify the USB hub or PC can supply the [required power](#) to the SIM before connecting.



The USB Mini-B Power input pin (+5V_USBFB) on various other connectors is directly connected to the USB Mini-B power input: **connecting any of these simultaneously may damage your SIM or even connected equipment such as a PC or USB Hub.**



[SHIPTide](#) and [SHIPEngine](#) communicate over the USB Device port to download and update the [SHIPEngine](#) and GUI cargo during the development and manufacturing processes.

USB A HOST CONNECTOR

Some SIM225 variants include USB 2.0 Full Speed (12 mbps max) embedded host circuitry on the RX MCU’s USB0 port along with the associated USB “A” Connector. See [USB Embedded Host Port](#) for details on the port functionality and [USB Host Power](#) for power enabling and limitations.

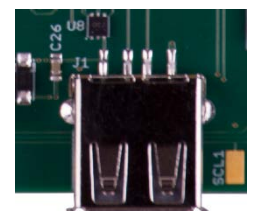

FFC EXPANSION CONNECTOR

The FFC Expansion Connector (if present) is the [FCI 10051922-2410ELF](#), a 24-position, 0.5mm, gold plated, bottom signal latching connector. There are few off-the-shelf FFC cables, so if the FFC Expansion Connector is used to connect a SIM225 to another system, the system designer will likely require a custom flex cable harness.

The FFC Expansion Connector exposes numerous GPIO signals from the MCU, including the same seven connections as the 7-pin [Power and Communications Connector](#). If desired, the FFC Expansion Connector can be the only external connection to the SIM225.

If the SIM225 family member has the RX63N (vs. RX631) MCU specified, the MCU's Reduced MII (RMII) Ethernet MAC connection is fully available on this connector for use with an external RMII PHY, magnetics, and 10/100 Ethernet jack.

The [RX63N/RX631](#) MCUs have extensive I/O multiplexers allowing one of many different peripheral functions to map to a given I/O pin: consult the [RX63N/RX631 hardware manuals](#) for the complete list of options.

+5V_EXT	1
P27/RMII_RX_ER	2
P22/ET_MDC	3
P21/ET_MDIO	4
P80/RMII_TXD_EN	5
P81/RMII_TXD0	6
P82/RMII_TXD1	7
GND	8
P25/RMII_RXD0	9
P24/RMII_RXD1	10
P83/RMII_CRS_DV	11
P26/REF50CK	12
P12/SCL0	13
P13/SDA0	14
GND	15
+5V_EXT	16
P07/SW1	17
RESET#	18
P03/DA0-P47/AN7	19
P01/RXD6	20
P00/TXD6	21
+3V3	22
GND	23
+5V_EXT	24



Several signals on this connector are directly connected to signals on other connectors, including +3V3, RESET#, +5V_EXT/+VEXT. **Ensure that common signal connections are appropriate or you may damage your SIM or connected equipment.**



[SHIPEngine](#) uses the primary UART0 supplied on pins 20 and 21 as the main communications mechanism for communicating with external systems.

JTAG CONNECTOR

The Renesas standard 14-pin debug connector allows simple connection to various debuggers and programmers, including the [Renesas E1](#) and the [Segger J-Link RX family of debuggers](#). A full description of the E1 interface can be found in the [E1/E20 Emulator Additional Notes for RX600 Family Application Note](#).



The 14-pin debug connector is not populated on some SIMs. To access these signals the [PCB Edge Connector](#) must be used with a [Serious Programming Adapter](#).

ADDITIONAL INFORMATION

The home page for technical documentation is: <http://www.seriousintegrated.com/w/index.php?title=SIM225>

Further documentation, including schematics, SolidWorks/STEP files, and more can be found there.

Schematics and other technical documentation for the SPA100 Programming Adapter can be found at www.seriousintegrated.com/docs/SPA100.

For more information on the SIM225:

- Visit www.seriousintegrated.com/SIM225
- Contact a [Serious manufacturers' representative](#)
- Contact a [Serious authorized distributor](#)
- Visit mySerious.com
- [Contact Serious](#) directly