



**± 1200uT Tri-axis Digital Magnetometer/
± 2g/4g/8g/16g Tri-axis Digital
Accelerometer Specifications**

PART NUMBER:

**KMX62-1031
Rev. 4.0
20-Dec-2017**

Product Description

KMX62 is a 6 Degrees-of-Freedom inertial sensor system that features 16-bit digital outputs accessed through I²C communication. The KMX62 sensor consists of a tri-axial magnetometer plus a tri-axial accelerometer coupled with an ASIC. It is packaged in a 3 x 3 x 0.9 mm Land Grid Array (LGA) package. The ASIC is realized in standard 0.18µm CMOS technology and features flexible user programmable ±2g / ±4g / ±8g / ±16g full scale range for the accelerometer and ±1200µT full scale range for the magnetometer. Accelerometer and Magnetometer data can be accumulated in an internal 384-byte FIFO buffer and transmitted to the application processor.

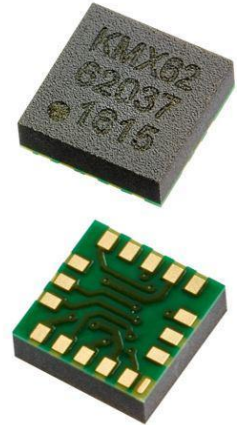

Acceleration sensing is based on the principle of a differential capacitance arising from acceleration-induced motion of the sense element, which utilizes common mode cancellation to decrease errors from process variation, temperature, and environmental stress. Capacitance changes are amplified and converted into digital signals which are processed by a dedicated digital signal processing unit. The digital signal processor applies filtering, bias, and sensitivity adjustments, as well as temperature compensation.

Magnetic sensing is based on the principle of magnetic impedance. The magnetic sensor detects very small magnetic fields by passing an electric pulse through a special electron spin aligned amorphous wire. Due to the high Curie temperature of the wire, the sensor's thermal performance shows excellent stability.

Noise performance is excellent with bias stability over temperature. Bias errors resulting from assembly can be trimmed digitally by the user. These sensors can accept supply voltages between 1.7V and 3.6V, and digital communication voltages between 1.2V and 3.6V.

	<p align="center">± 1200uT Tri-axis Digital Magnetometer/ ± 2g/4g/8g/16g Tri-axis Digital Accelerometer Specifications</p>	<p>PART NUMBER: KMX62-1031 Rev. 4.0 20-Dec-2017</p>
---	---	--

Table of Contents

PRODUCT DESCRIPTION1

TABLE OF CONTENTS.....2

FUNCTIONAL DIAGRAM5

PRODUCT SPECIFICATIONS.....6

 MECHANICAL..... 6

 Magnetometer 6

 Accelerometer 7

 Temperature Sensor 8

 ELECTRICAL..... 8

 Start Up Time Profile 9

 Current Profile 10

 Power-On Procedure 11

 ENVIRONMENTAL 12

 APPLICATION SCHEMATIC AND PIN DESCRIPTION 13

 Application Schematic..... 13

 Pin Description 13

 PACKAGE DIMENSIONS AND ORIENTATION 14

 Dimensions 14

 Orientation 15

DIGITAL INTERFACE.....18

 I²C SERIAL INTERFACE..... 18

 I²C Operation..... 19

 Writing to an 8-bit Register..... 20

 Reading from an 8-bit Register 21

 Data Transfer Sequences..... 22

 HS-mode..... 23

 I²C TIMING DIAGRAM 24

POWER MODES.....25

 OFF MODE 25

 INITIAL STARTUP..... 25

 STAND-BY MODE 26

 SLEEP MODE 26

 LOW POWER (<RES> = 00 OR 01) MODE..... 26

 HIGH RESOLUTION (<RES> = 10 OR 11) MODE 26

EMBEDDED REGISTERS.....27

REGISTER DESCRIPTIONS.....28

 WHO_AM_I..... 28

 INS1 - INTERRUPT SOURCE REGISTER 1 28



**± 1200uT Tri-axis Digital Magnetometer/
± 2g/4g/8g/16g Tri-axis Digital
Accelerometer Specifications**

PART NUMBER:

**KMX62-1031
Rev. 4.0
20-Dec-2017**

INS2 - INTERRUPT SOURCE REGISTER 2 29
 INS3 - INTERRUPT SOURCE REGISTER 3 30
 INL - INTERRUPT LATCH RELEASE..... 30
 ACCELEROMETER OUTPUT 31
 ACCEL_XOUT_L..... 31
 ACCEL_XOUT_H..... 31
 ACCEL_YOUT_L..... 32
 ACCEL_YOUT_H..... 32
 ACCEL_ZOUT_L..... 32
 ACCEL_ZOUT_H..... 32
 MAGNETOMETER OUTPUT..... 33
 MAG_XOUT_L 33
 MAG_XOUT_H..... 33
 MAG_YOUT_L..... 34
 MAG_YOUT_H..... 34
 MAG_ZOUT_L..... 34
 MAG_ZOUT_H..... 34
 TEMPERATURE OUTPUT 35
 TEMP_OUT_L 36
 TEMP_OUT_H..... 36
 INC1 - INTERRUPT CONTROL 1 36
 INC2 - INTERRUPT CONTROL 2 37
 INC3 - INTERRUPT CONTROL 3 38
 INC4 - INTERRUPT CONTROL 4 39
 INC5 - INTERRUPT CONTROL 5 39
 AMI_CNTL1 - ACCELEROMETER MOTION CONTROL 1 40
 AMI_CNTL2 - ACCELEROMETER MOTION CONTROL 2 40
 AMI_CNTL3 - ACCELEROMETER MOTION CONTROL 3 41
 MMI_CNTL1 - MAGNETOMETER MOTION CONTROL 1..... 42
 MMI_CNTL2 - MAGNETOMETER MOTION CONTROL 2..... 42
 MMI_CNTL3 - MAGNETOMETER MOTION CONTROL 3..... 43
 FFI_CNTL1 - FREE FALL CONTROL 1 44
 FFI_CNTL2 - FREE FALL CONTROL 2 44
 FFI_CNTL3 - FREE FALL CONTROL 3 45
 ODCNTL - OUTPUT DATA CONTROL REGISTER 46
 CNTL1 - CONTROL REGISTER 1..... 48
 CNTL2 - CONTROL REGISTER 2..... 49
 COTR - COMMAND TEST RESPONSE 50
 BUF_CTRL_1,2,3..... 51
 BUF_CLEAR 52
 BUF_STATUS_1,2,3 52
 BUF_READ..... 53

EMBEDDED APPLICATIONS 54

 ACCELEROMETER MOTION INTERRUPT FEATURE 54



**± 1200uT Tri-axis Digital Magnetometer/
± 2g/4g/8g/16g Tri-axis Digital
Accelerometer Specifications**

PART NUMBER:

**KMX62-1031
Rev. 4.0
20-Dec-2017**

MAGNETOMETER MOTION INTERRUPT FEATURE 56

FREE FALL DETECT..... 57

SAMPLE BUFFER FEATURE DESCRIPTION..... 59

FIFO Mode..... 59

Stream Mode..... 59

Trigger Mode..... 60

FIFO Mode..... 60

Buffer Operation 60

REVISION HISTORY67

APPENDIX68



**$\pm 1200\mu\text{T}$ Tri-axis Digital Magnetometer/
 $\pm 2\text{g}/4\text{g}/8\text{g}/16\text{g}$ Tri-axis Digital
Accelerometer Specifications**

PART NUMBER:

**KMX62-1031
Rev. 4.0
20-Dec-2017**

Functional Diagram

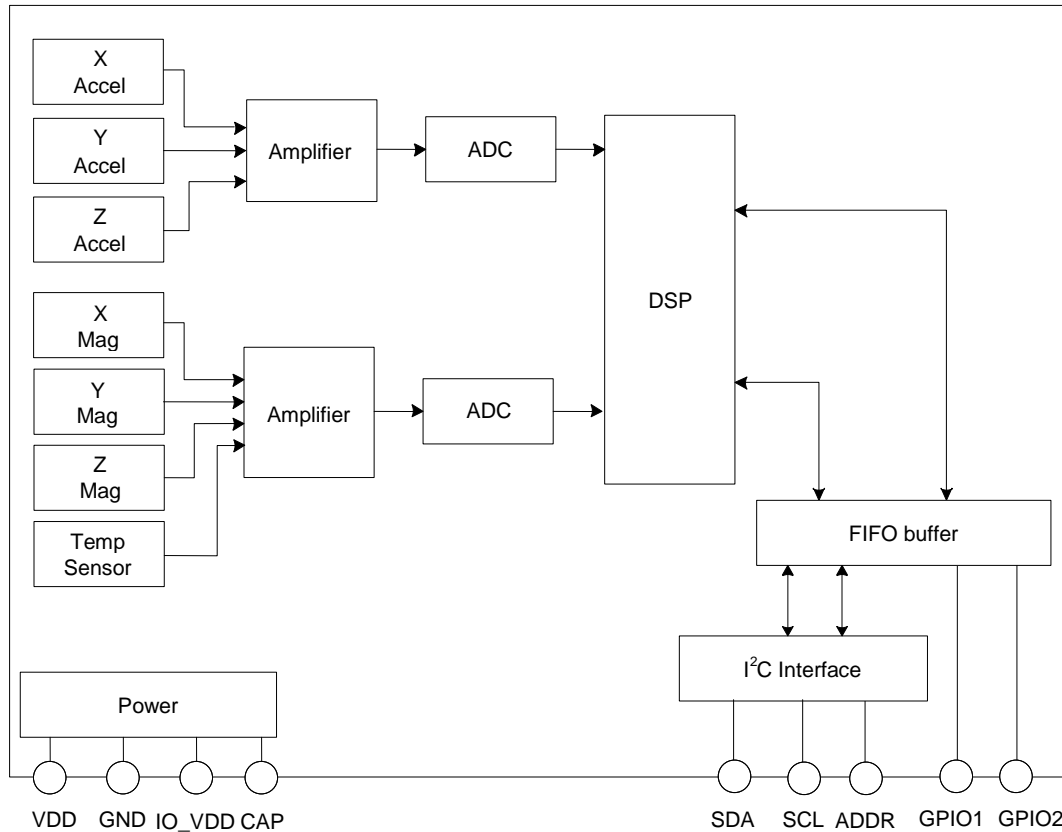

	± 1200uT Tri-axis Digital Magnetometer/ ± 2g/4g/8g/16g Tri-axis Digital Accelerometer Specifications	PART NUMBER: KMX62-1031 Rev. 4.0 20-Dec-2017
---	---	---

Product Specifications

Note: Specifications are for operation at VDD = 2.5V, T = 25°C, High Resolution Mode (<RES> = 10, 11) unless stated otherwise.

Mechanical

Magnetometer

Parameters	Units	Min	Typical	Max
Operating Temperature Range	°C	-40	-	+85
Full Scale Range	μT		±1200	
Digital Bit Depth	bits		16	
Offset at Zero Magnetic Field	μT		0	
Offset Temperature Coefficient	μT/°C		±0.3	
Magnetic Sensitivity	counts/μT		27.3	
Sensitivity Accuracy	%		±20	
Sensitivity Temperature Coefficient.	%/°C		±0.05	
Positive Self Test Output change on Activation	μT		800	
Integral Non-Linearity	% of FS		0.5	
Noise ^{1,2}	μT (RMS)		0.3	
Cross Axis Sensitivity	% of FS		2 (XY) 0.5 (XZ) 0.3 (YX) 0.2 (YZ) 0.9 (ZX) 0.2 (ZY)	
Maximum Exposed Field ³	μT			500000

Table 1: Magnetometer Specifications

Notes:

- Noise varies with Output Data Rate (ODR) as set by OSM<3:0> bits in ODCNTL and RES<1:0> bits in CNTL2 registers.
- Measured at ODR = 50Hz, RES = 10, 11.
- No permanent effect on Zero Magnetic Field Offset



**± 1200uT Tri-axis Digital Magnetometer/
± 2g/4g/8g/16g Tri-axis Digital
Accelerometer Specifications**

PART NUMBER:

**KMX62-1031
Rev. 4.0
20-Dec-2017**

Accelerometer

Parameters		Units	Min	Typical	Max
Operating Temperature Range		°C	-40	-	+85
Full Scale Range	GSEL1=0, GSEL0=0	g		±2	
	GSEL1=0, GSEL0=1			±4	
	GSEL1=1, GSEL0=0			±8	
	GSEL1=1, GSEL0=1			±16	
Digital Bit Depth				16	
Zero-g Offset		mg		±25	±90
Zero-g Offset Temperature Coefficient		mg/°C		±0.25	
Sensitivity	GSEL1=0, GSEL0=0 (±2g)	counts/g		16384	
	GSEL1=0, GSEL0=1 (±4g)			8192	
	GSEL1=1, GSEL0=0 (±8g)			4096	
	GSEL1=1, GSEL0=1 (±16g)			2048	
Sensitivity Accuracy		%		±5	
Sensitivity Temperature Coefficient		%/°C		±0.01	
Positive Self Test Output change on Activation		g	0.25 (xy) 0.2 (z)	0.5	0.75
Signal Bandwidth (-3dB)		Hz		3500 (xy) 1800 (z)	
Integral Non-Linearity		% of FS		1	
Cross Axis Sensitivity ¹		%		-2 (XY) 0.1 (XZ) 2.7 (YX) -0.7 (YZ) -0.8 (ZX) 1.4 (ZY)	
Noise ^{2,3}	RMS	mg		0.75	
	Density	µg/√Hz		130	

Table 2: Accelerometer Specifications

Notes:

1. As measured in a test socket at the factory. The cross-axis sensitivity that is measured is the by-product of positional inaccuracies at all stages of test and assembly.
2. Noise varies with Output Data Rate (ODR) as set by OSA<3:0> bits in ODCNTL, and RES<1:0> bits in CNTL2 registers.
3. Measured at ODR = 50Hz, RES = 10, 11.



**± 1200uT Tri-axis Digital Magnetometer/
± 2g/4g/8g/16g Tri-axis Digital
Accelerometer Specifications**

PART NUMBER:

**KMX62-1031
Rev. 4.0
20-Dec-2017**

Temperature Sensor

(specifications are for operation at VDD = 2.5V and T = 25°C unless stated otherwise)

Parameters	Units	Min	Typical	Max
Operating Temperature Range	°C	-40	-	+85
Output Accuracy	± °C		5	
Sensitivity (16-bit digital)	counts/°C		256	
Sensitivity (8-bit digital, TEMP<15:8>)	counts/°C		1	

Table 3: Temperature Sensor Mechanical Specifications

Electrical

Parameters		Units	Min	Typical	Max
Supply Voltage (VDD)	Operating	V	1.7	2.5	3.6
I/O Pads Supply Voltage (IO_VDD)		V	1.2		3.6
Current Consumption ¹ (High Resolution Mode) (<RES> = 10 or 11)	Operating (mag + accel)	µA		395	
	Magnetometer only			295	
	Accelerometer only			150	
	Standby			1	5
Output Low Voltage ² (IO_VDD < 2V)		V	-	-	0.2 * IO_VDD
Output Low Voltage ² (IO_VDD ≥ 2V)		V	-	-	0.4
Output High Voltage		V	0.9 * IO_VDD	-	-
Input Low Voltage		V	-	-	0.3 * IO_VDD
Input High Voltage		V	0.7 * IO_VDD	-	-
I ² C Communication Rate ^{3,4}		kHz	100	400	3400
I ² C Slave Address (7-bit)				0x0E / 0x0F	
Output Data Rate (ODR)		Hz	0.781	100	1600
Bandwidth (-3dB) ⁵	RES 00,01	Hz		400	
	RES 10,11	Hz		ODR/2	
Internal Oscillator Tolerance		%	-10		10
Start Up Time ⁶		ms	1		1300

Table 4: Electrical Specifications

Notes:

1. See Figure 2 for other modes (RES = 00 or 01)
2. Assuming I²C communication and minimum 1.5kΩ pull-up resistor on SCL and SDA
3. Assuming max bus capacitance load of 20pF
4. The I²C bus supports Standard-Mode, Fast-Mode, and High-Speed Mode.
5. User selectable via ODR control register setting
6. Start up time is from ACCEL_EN / MAG_EN set to valid outputs. Time varies with Output Data Rate (ODR) and mode setting (RES) (see Figure 1).



**± 1200uT Tri-axis Digital Magnetometer/
± 2g/4g/8g/16g Tri-axis Digital
Accelerometer Specifications**

PART NUMBER:

**KMX62-1031
Rev. 4.0
20-Dec-2017**

Start Up Time Profile

Typical Start Up Time over selected ODR (0.781,1.563,3.125,6.25,12.5,25,50,100,200,400,800,1600Hz)

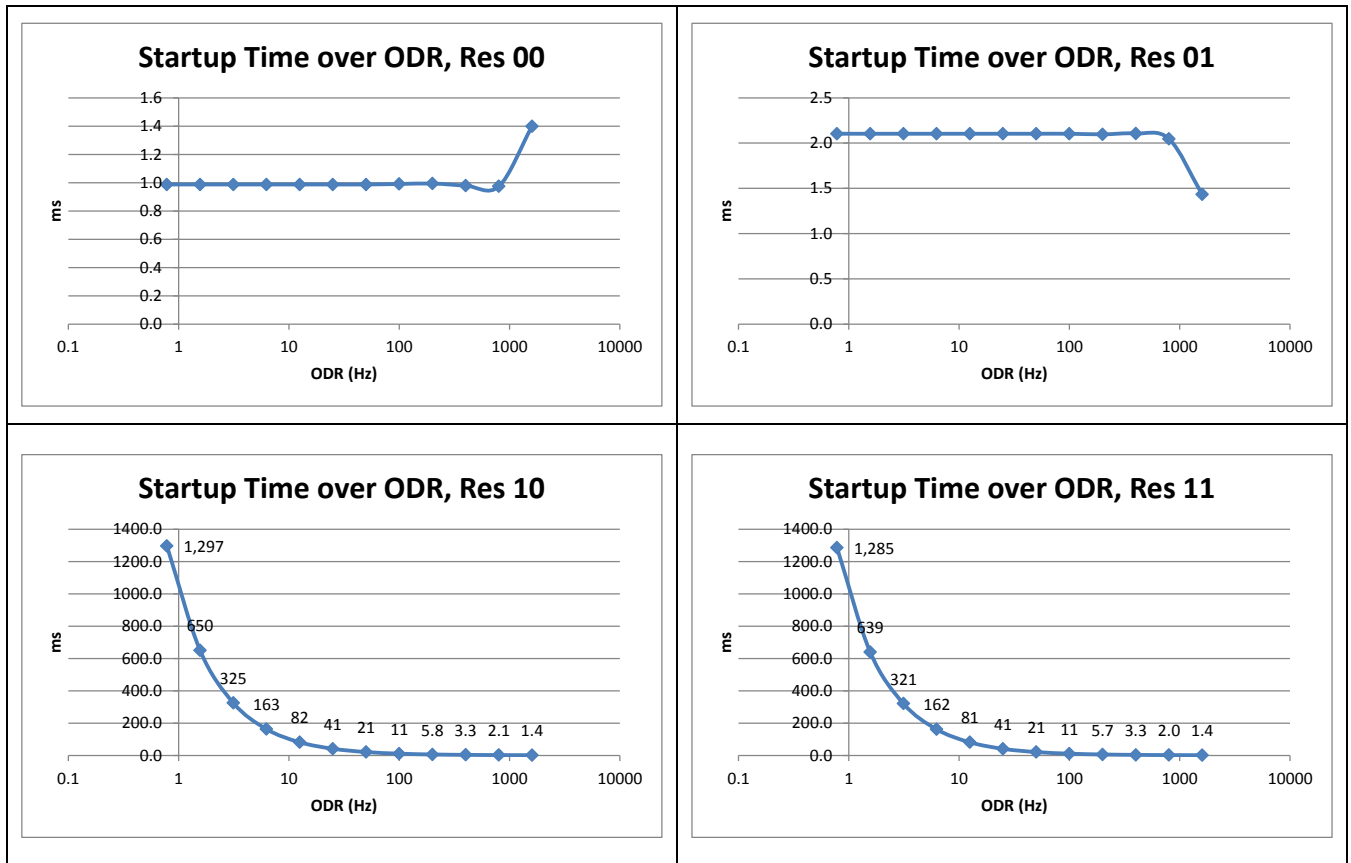

Figure 1: Start Up Time Diagram



**± 1200uT Tri-axis Digital Magnetometer/
± 2g/4g/8g/16g Tri-axis Digital
Accelerometer Specifications**

PART NUMBER:

**KMX62-1031
Rev. 4.0
20-Dec-2017**

Current Profile

Typical current over selected ODR (0.781,1.563,3.125,6.25,12.5,25,50,100,200,400,800,1600Hz) @ VDD = 2.5V and T = 25°C

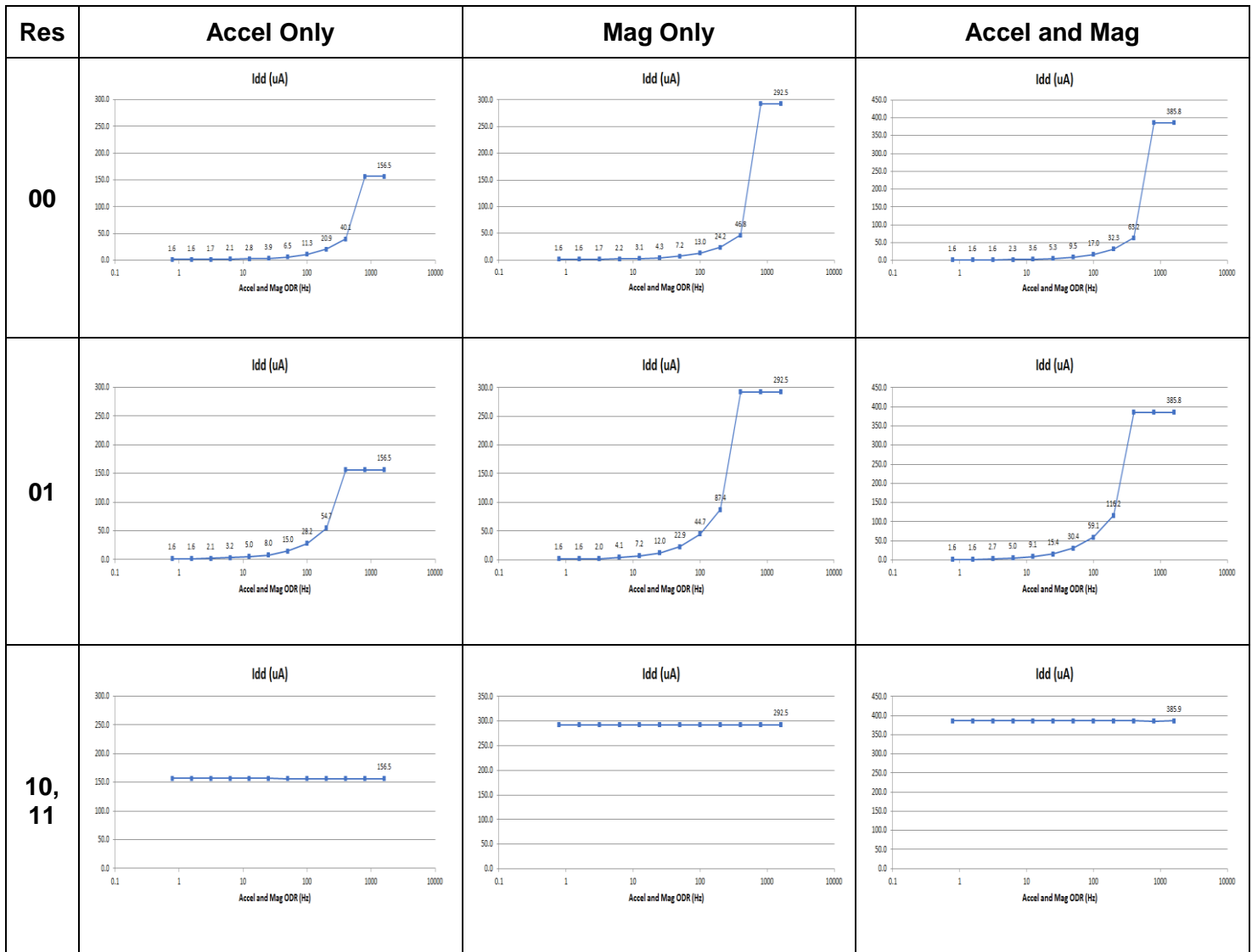

Figure 2: Current Consumption Diagram

	<p align="center">± 1200uT Tri-axis Digital Magnetometer/ ± 2g/4g/8g/16g Tri-axis Digital Accelerometer Specifications</p>	<p>PART NUMBER: KMX62-1031 Rev. 4.0 20-Dec-2017</p>
---	---	---

Power-On Procedure

Proper functioning of power-on reset (POR) is dependent on the specific **VDD**, **VDD_{LOW}**, **T_{VDD}** (rise time), and **T_{VDD_OFF}** profile of individual applications. It is recommended to minimize **VDD_{LOW}**, and **T_{VDD}**, and maximize **T_{VDD_OFF}**. It is also advised that the VDD ramp up time **T_{VDD}** be monotonic. Note that the outputs will not be stable until **VDD** has reached its final value.

- ! *To assure proper POR, the application should be evaluated over the customer specified range of VDD, VDD_{LOW}, T_{VDD}, T_{VDD_OFF} and temperature as POR performance can vary depending on these parameters.*

Please refer to Technical Note [TN005 Power-On Procedure](#) for more information.

	<p align="center">± 1200uT Tri-axis Digital Magnetometer/ ± 2g/4g/8g/16g Tri-axis Digital Accelerometer Specifications</p>	<p>PART NUMBER: KMX62-1031 Rev. 4.0 20-Dec-2017</p>
---	---	--

Environmental

Parameters		Units	Min	Typical	Max
Supply Voltage (VDD)	Absolute Limits	V	-0.3	-	3.6
Operating Temperature Range		°C	-40	-	85
Storage Temperature Range		°C	-55	-	150
Mech. Shock (powered and unpowered)		g	-	-	5000 for 0.5ms 10000 for 0.2ms
ESD	HBM	V	-	-	2000

Table 5: Environmental Specifications



Caution: ESD Sensitive and Mechanical Shock Sensitive Component, improper handling can cause permanent damage to the device.



These products conform to RoHS Directive 2011/65/EU of the European Parliament and of the Council of the European Union that was issued June 8, 2011. Specifically, these products do not contain any non-exempted amounts of lead, mercury, cadmium, hexavalent chromium, polybrominated biphenyls (PBB) or polybrominated diphenyl ethers (PBDE) above the maximum concentration values (MCV) by weight in any of its homogenous materials. Homogenous materials are “of uniform composition throughout”. The MCV for lead, mercury, hexavalent chromium, PBB, and PBDE is 0.10%. The MCV for cadmium is 0.010%.

Applicable Exemption: 7C-1 - *Electrical and electronic components containing lead in a glass or ceramic other than dielectric ceramic in capacitors (piezoelectric devices) or in a glass or ceramic matrix compound.*



These products are also in conformance with REACH Regulation No 1907/2006 of the European Parliament and of the Council that was issued Dec. 30, 2011. They do not contain any Substances of Very High Concern (SVHC-174) as identified by the European Chemicals Agency as of 12 July 2017.



This product is halogen-free per IEC 61249-2-21. Specifically, the materials used in this product contain a maximum total halogen content of 1500 ppm with less than 900-ppm bromine and less than 900-ppm chlorine.

Soldering

Soldering recommendations are available upon request or from www.kionix.com.



**± 1200uT Tri-axis Digital Magnetometer/
± 2g/4g/8g/16g Tri-axis Digital
Accelerometer Specifications**

PART NUMBER:

**KMX62-1031
Rev. 4.0
20-Dec-2017**

Application Schematic and Pin Description

Application Schematic

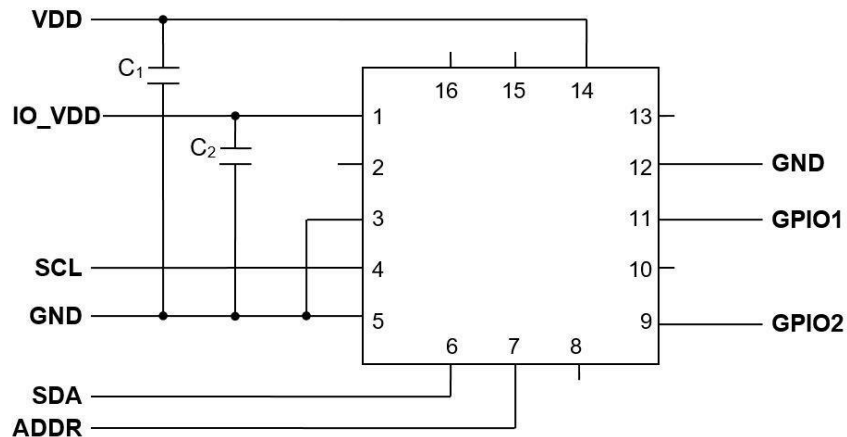

Pin Description

Pin	Name	Description
1	IO_VDD	The power supply input for the digital communication bus. Optionally decouple this pin to ground with a 0.1uF ceramic capacitor.
2	CAP	Do not connect. Must be left floating.
3	GND	Ground
4	SCL	I2C Serial Clock
5	GND	Ground
6	SDA	I2C Serial Data
7	ADDR	I2C Address pin. This pin must be connected to IO_VDD or GND to determine the I2C Device Address.
8	NC	Not Internally Connected - Can be connected to VDD, IO_VDD, GND or leave floating.
9	GPIO2	GPIO 2. Cannot float when configured as an input.
10	NC	Not Internally Connected - Can be connected to VDD, IO_VDD, GND or leave floating.
11	GPIO1	GPIO 1. Cannot float when configured as an input.
12	GND	Ground
13	NC	Not Internally Connected - Can be connected to VDD, IO_VDD, GND or leave floating.
14	VDD	The power supply input. Decouple this pin to ground with a 0.1uF ceramic capacitor.
15	NC	Not Internally Connected - Can be connected to VDD, IO_VDD, GND or leave floating.
16	NC	Not Internally Connected - Can be connected to VDD, IO_VDD, GND or leave floating.

Table 6: Pin Description

Note: Pins 3, 5, and 12 (GND) are internally tied together.



**± 1200uT Tri-axis Digital Magnetometer/
± 2g/4g/8g/16g Tri-axis Digital
Accelerometer Specifications**

PART NUMBER:

**KMX62-1031
Rev. 4.0
20-Dec-2017**

Package Dimensions and Orientation

Dimensions

3 x 3 x 0.9 mm LGA

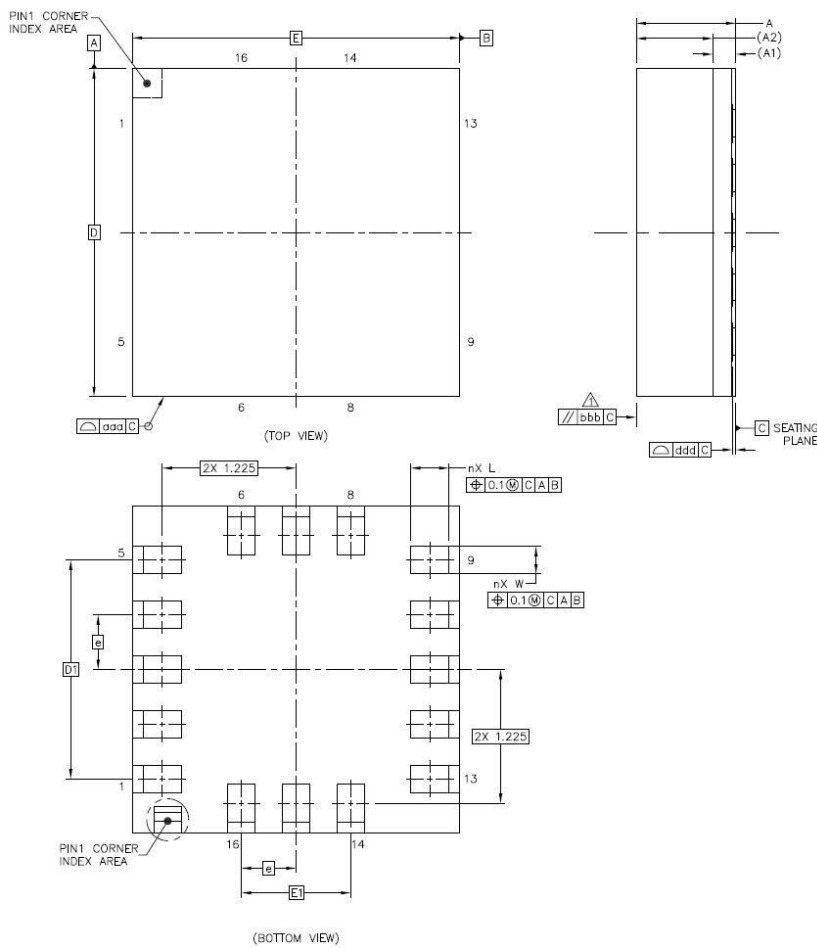

	SYMBOL	COMMON DIMENSIONS		
		MIN.	NOM.	MAX.
TOTAL THICKNESS	A	----	----	1
SUBSTRATE THICKNESS	A1	----	0.21	REF
MOLD THICKNESS	A2	----	0.7	REF
BODY SIZE	D	----	3	BSC
	E	----	3	BSC
LEAD WIDTH	W	0.2	0.25	0.3
LEAD LENGTH	L	0.3	0.35	0.4
LEAD PITCH	e	----	0.5	BSC
LEAD COUNT	n	----	16	----
EDGE BALL CENTER TO CENTER	D1	----	2	BSC
	E1	----	1	BSC
BODY CENTER TO CONTACT BALL	SD	----	----	BSC
	SE	----	----	BSC
BALL WIDTH	b	----	----	----
BALL DIAMETER		----	----	----
BALL OPENING		----	----	----
BALL PITCH	e1	----	----	----
BALL COUNT	n1	----	----	----
PRE-SOLDER		----	----	----
PACKAGE EDGE TOLERANCE	aaa	----	0.1	----
MOLD FLATNESS	bbb	----	0.2	----
COPLANARITY	ddd	----	0.08	----
BALL OFFSET (PACKAGE)	eee	----	----	----
BALL OFFSET (BALL)	fff	----	----	----

NOTES:

△ PARALLELISM MEASUREMENT SHALL EXCLUDE ANY EFFECT OF MARK ON TOP SURFACE OF PACKAGE.

All dimensions and tolerances conform to ASME Y14.5M-1994

	<p align="center">± 1200uT Tri-axis Digital Magnetometer/ ± 2g/4g/8g/16g Tri-axis Digital Accelerometer Specifications</p>	<p>PART NUMBER: KMX62-1031 Rev. 4.0 20-Dec-2017</p>
---	---	---

Orientation

When device is accelerated in +X, +Y or +Z direction, the corresponding output will increase. When the +X, +Y, or +Z arrow is directed toward North, the output of that axis is positive.

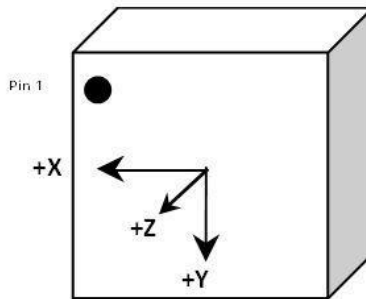



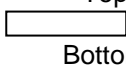
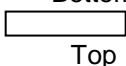

Figure 3: Accelerometer and Magnetometer Orientation

Please avoid mounting this product on the part in which magnetic field disturbance exists, such as near any parts containing ferrous materials.

Static X/Y/Z Output Response versus Orientation to Earth’s surface (1g):
GSEL1=0, GSEL0=0 (±2g)

Position	1	2	3	4	5	6
Diagram						
Resolution (bits)	16	16	16	16	16	16
X (counts)	0	-16384	0	+16384	0	0
Y (counts)	-16384	0	+16384	0	0	0
Z (counts)	0	0	0	0	+16384	-16384
X-Polarity	0	-	0	+	0	0
Y-Polarity	-	0	+	0	0	0
Z-Polarity	0	0	0	0	+	-



Earth’s Surface



**± 1200uT Tri-axis Digital Magnetometer/
± 2g/4g/8g/16g Tri-axis Digital
Accelerometer Specifications**

PART NUMBER:

**KMX62-1031
Rev. 4.0
20-Dec-2017**

Static X/Y/Z Output Response versus Orientation to Earth's surface (1g):
GSEL1=0, GSEL0=1 (±4g)

Position	1	2	3	4	5	6
Diagram						
Resolution (bits)	16	16	16	16	16	16
X (counts)	0	-8192	0	+8192	0	0
Y (counts)	-8192	0	+8192	0	0	0
Z (counts)	0	0	0	0	+8192	-8192
X-Polarity	0	-	0	+	0	0
Y-Polarity	-	0	+	0	0	0
Z-Polarity	0	0	0	0	+	-



Earth's Surface

Static X/Y/Z Output Response versus Orientation to Earth's surface (1g):
GSEL1=1, GSEL0=0 (±8g)

Position	1	2	3	4	5	6
Diagram						
Resolution (bits)	16	16	16	16	16	16
X (counts)	0	-4096	0	+4096	0	0
Y (counts)	-4096	0	+4096	0	0	0
Z (counts)	0	0	0	0	+4096	-4096
X-Polarity	0	-	0	+	0	0
Y-Polarity	-	0	+	0	0	0
Z-Polarity	0	0	0	0	+	-



Earth's Surface



**± 1200uT Tri-axis Digital Magnetometer/
± 2g/4g/8g/16g Tri-axis Digital
Accelerometer Specifications**

PART NUMBER:

**KMX62-1031
Rev. 4.0
20-Dec-2017**

Static X/Y/Z Output Response versus Orientation to Earth's surface (1g):
GSEL1=0, GSEL0=1 (±16g)

Position	1	2	3	4	5	6
Diagram						
Resolution (bits)	16	16	16	16	16	16
X (counts)	0	-2048	0	+2048	0	0
Y (counts)	-2048	0	+2048	0	0	0
Z (counts)	0	0	0	0	+2048	-2048
X-Polarity	0	-	0	+	0	0
Y-Polarity	-	0	+	0	0	0
Z-Polarity	0	0	0	0	+	-



Earth's Surface

	<p align="center">± 1200uT Tri-axis Digital Magnetometer/ ± 2g/4g/8g/16g Tri-axis Digital Accelerometer Specifications</p>	<p>PART NUMBER: KMX62-1031 Rev. 4.0 20-Dec-2017</p>
---	---	---

Digital Interface

The Kionix KMX62 digital sensor can communicate on the I²C digital serial interface bus. This flexibility allows for easy system integration by eliminating analog-to-digital converter requirements and by providing direct communication with system processors. The I²C interface is compliant with high-speed mode, fast mode, and standard mode I²C protocols.

The serial interface terms and descriptions as indicated in Table 7 below will be observed throughout this document.

Term	Description
Transmitter	The device that transmits data to the bus.
Receiver	The device that receives data from the bus.
Master	The device that initiates a transfer, generates clock signals, and terminates a transfer.
Slave	The device addressed by the Master.

Table 7: Serial Interface Terminologies

I²C Serial Interface

As previously mentioned, the KMX62 can communicate on an I²C bus. I²C is primarily used for synchronous serial communication between a Master device and one or more Slave devices. The system Master provides the serial clock signal and addresses Slave devices on the bus. The KMX62 always operates as a Slave device during standard Master-Slave I²C operation.

I²C is a two-wire serial interface that contains a Serial Clock (SCL) line and a Serial Data (SDA) line. SCL is a serial clock that is provided by the Master, but can be held LOW by any Slave device, putting the Master into a wait condition. SDA is a bi-directional line used to transmit and receive data to and from the interface. Data is transmitted MSB (Most Significant Bit) first in 8-bit per byte format, and the number of bytes transmitted per transfer is unlimited. The I²C bus is considered free when both lines are HIGH.



**± 1200uT Tri-axis Digital Magnetometer/
± 2g/4g/8g/16g Tri-axis Digital
Accelerometer Specifications**

PART NUMBER:

**KMX62-1031
Rev. 4.0
20-Dec-2017**

I²C Operation

Transactions on the I²C bus begin after the Master transmits a start condition (S), which is defined as a HIGH-to-LOW transition on the data line while the SCL line is held HIGH. The bus is considered busy after this condition. The next byte of data transmitted after the start condition contains the Slave Address (SAD) in the seven MSBs (Most Significant Bits), and the LSB (Least Significant Bit) tells whether the Master will be receiving data '1' from the Slave or transmitting data '0' to the Slave. When a Slave Address is sent, each device on the bus compares the seven MSBs with its internally-stored address. If they match, the device considers itself addressed by the Master. The KMX62 Slave Address is comprised of a user programmable part, a factory programmable part, and a fixed part, which allows for connection of multiple sensors to the same I²C bus. The Slave Address associated with the KMX62 is 00011YX, where the user programmable bit X, is determined by the assignment of ADDR (pin 7) to GND or IO_VDD. Also, the factory programmable bit Y is set at the factory. **For KMX62-1031, the factory programmable bit Y is fixed to 1** (contact your Kionix sales representative for list of available devices). Table 8 lists possible I²C addresses for KMX62-1031. It is possible to have up to four sensors on a shared I²C bus as shown in Figure 4 (i.e. two KMX62-1031 accelerometer/magnetometer and two additional accelerometer/magnetometer with the factory programmable bit Y set to 0).

Description	Address Pad	7-bit Address	Address	<7>	<6>	<5>	<4>	<3>	Y	X	<0>
									<2>	<1>	
I ² C Wr	GND	0x0E	0x1C	0	0	0	1	1	1	0	0
I ² C Rd	GND	0x0E	0x1D	0	0	0	1	1	1	0	1
I ² C Wr	IO_VDD	0x0F	0x1E	0	0	0	1	1	1	1	0
I ² C Rd	IO_VDD	0x0F	0x1F	0	0	0	1	1	1	1	1

Table 8: I²C Address

It is mandatory that receiving devices acknowledge (ACK) each transaction. Therefore, the transmitter must release the SDA line during this ACK pulse. The receiver then pulls the data line LOW so that it remains stable LOW during the HIGH period of the ACK clock pulse. A receiver that has been addressed, whether it is Master or Slave, is obliged to generate an ACK after each byte of data has been received. To conclude a transaction, the Master must transmit a stop condition (P) by transitioning the SDA line from LOW to HIGH while SCL is HIGH. The I²C bus is now free. Note that if the KMX62 is accessed through I²C protocol before the startup is finished a NACK signal is sent.



**± 1200uT Tri-axis Digital Magnetometer/
± 2g/4g/8g/16g Tri-axis Digital
Accelerometer Specifications**

PART NUMBER:

**KMX62-1031
Rev. 4.0
20-Dec-2017**

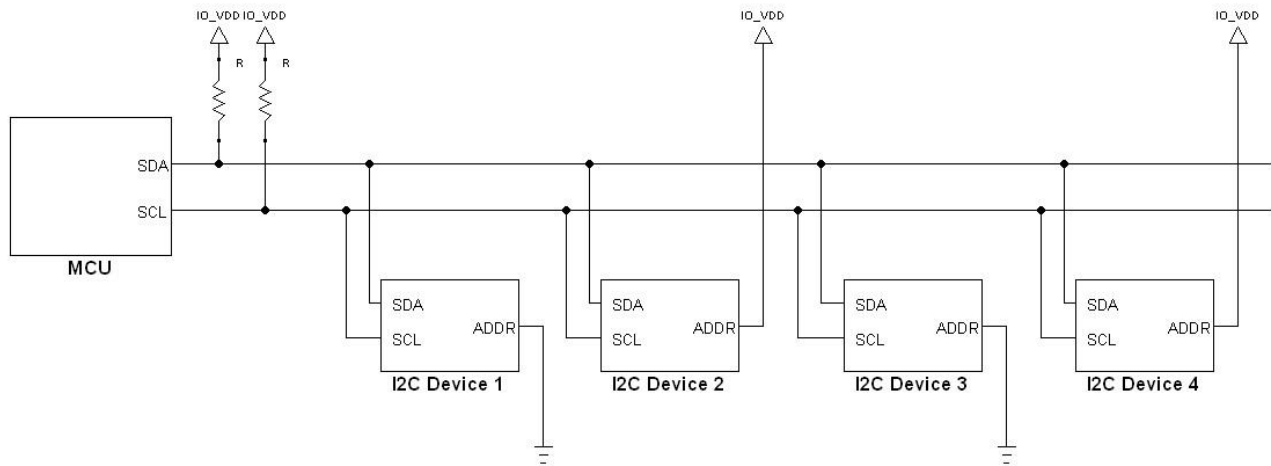

I2C Device	Part Number	ADDR Pin	Slave Address	Bit Y (Bit 1 in 7-bit address)
1	KMX62-1031	GND	0x0E	Factory Set to 1
2	KMX62-1031	IO_VDD	0x0F	Factory Set to 1
3	*KXMMM	GND	0x0C	Factory Set to 0
4	*KXMMM	IO_VDD	0x0D	Factory Set to 0

* KXMMM – contact Kionix sales representative for list of compatible devices

Figure 4: Multiple KMX62 I²C Connection

Writing to an 8-bit Register

Upon power up, the Master must write to the KMX62's control registers to set its operational mode. Therefore, when writing to a control register on the I²C bus, as shown Sequence 1 on the following page, the following protocol must be observed: After a start condition, SAD+W transmission, and the KMX62 ACK has been returned, an 8-bit Register Address (RA) command is transmitted by the Master. This command is telling the KMX62 to which 8-bit register the Master will be writing the data. Since this is I²C mode, the MSB of the RA command should always be zero (0). The KMX62 acknowledges the RA and the Master transmits the data to be stored in the 8-bit register. The KMX62 acknowledges that it has received the data and the Master transmits a stop condition (P) to end the data transfer. The data sent to the KMX62 is now stored in the appropriate register. The KMX62 automatically increments the received RA commands and, therefore, multiple bytes of data can be written to sequential registers after each Slave ACK as shown in Sequence 2 on the following page.

	<p align="center">± 1200uT Tri-axis Digital Magnetometer/ ± 2g/4g/8g/16g Tri-axis Digital Accelerometer Specifications</p>	<p>PART NUMBER: KMX62-1031 Rev. 4.0 20-Dec-2017</p>
---	---	--

Reading from an 8-bit Register

When reading data from a KMX62 8-bit register on the I²C bus, as shown in Sequence 3 on the next page, the following protocol must be observed: The Master first transmits a start condition (S) and the appropriate Slave Address (SAD) with the LSB set at '0' to write. The KMX62 acknowledges and the Master transmits the 8-bit RA of the register it wants to read. The KMX62 again acknowledges, and the Master transmits a repeated start condition (Sr). After the repeated start condition, the Master addresses the KMX62 with a '1' in the LSB (SAD+R) to read from the previously selected register. The Slave then acknowledges and transmits the data from the requested register. The Master does not acknowledge (NACK) it received the transmitted data, but transmits a stop condition to end the data transfer. The KMX62 automatically increments through its sequential registers, allowing data to be read from multiple registers following a single SAD+R command as shown below in Sequence 4 on the following page. Reading data from a buffer read register is a special case because if register address (RA) is set to buffer read register (BUF_READ) in Sequence 4, the register auto-increment feature is automatically disabled. Instead, the Read Pointer will increment to the next data in the buffer, thus allowing reading multiple bytes of data from the buffer using a single SAD+R command.



**± 1200uT Tri-axis Digital Magnetometer/
± 2g/4g/8g/16g Tri-axis Digital
Accelerometer Specifications**

PART NUMBER:

**KMX62-1031
Rev. 4.0
20-Dec-2017**

Data Transfer Sequences

The following information clearly illustrates the variety of data transfers that can occur on the I²C bus and how the Master and Slave interact during these transfers. Table 9 defines the I²C terms used during the data transfers.

Term	Definition
S	Start Condition
Sr	Repeated Start Condition
SAD	Slave Address
W	Write Bit
R	Read Bit
ACK	Acknowledge
NACK	Not Acknowledge
RA	Register Address
Data	Transmitted/Received Data
P	Stop Condition

Table 9: I²C Terms

Sequence 1: The Master is writing one byte to the Slave.

Master	S	SAD + W		RA		DATA		P
Slave			ACK		ACK		ACK	

Sequence 2: The Master is writing multiple bytes to the Slave.

Master	S	SAD + W		RA		DATA		DATA		P
Slave			ACK		ACK		ACK		ACK	

Sequence 3: The Master is receiving one byte of data from the Slave.

Master	S	SAD + W		RA		Sr	SAD + R			NACK	P
Slave			ACK		ACK			ACK	DATA		

Sequence 4: The Master is receiving multiple bytes of data from the Slave.

Master	S	SAD + W		RA		Sr	SAD + R			ACK		NACK	P
Slave			ACK		ACK			ACK	DATA		DATA		

	<p align="center">± 1200uT Tri-axis Digital Magnetometer/ ± 2g/4g/8g/16g Tri-axis Digital Accelerometer Specifications</p>	<p>PART NUMBER: KMX62-1031 Rev. 4.0 20-Dec-2017</p>
---	---	--

HS-mode

To enter the 3.4MHz high speed mode of communication, the device must receive the following sequence of conditions from the master: A Start condition followed by a Master code (00001XXX) and a Master Non-acknowledge. Once recognized, the device switches to HS-mode communication. Read/write data transfers then proceed as described in the sequences above. Devices return to the FS-mode after a STOP occurrence on the bus.

Sequence 5: HS-mode data transfer of the Master writing one byte to the Slave.

Speed	FS-mode			HS-mode							FS-mode	
	S	M-code	NACK	S	SAD + W		RA		DATA			P
Master												
Slave						ACK		ACK		ACK		



**± 1200uT Tri-axis Digital Magnetometer/
± 2g/4g/8g/16g Tri-axis Digital
Accelerometer Specifications**

PART NUMBER:

**KMX62-1031
Rev. 4.0
20-Dec-2017**

I²C Timing Diagram

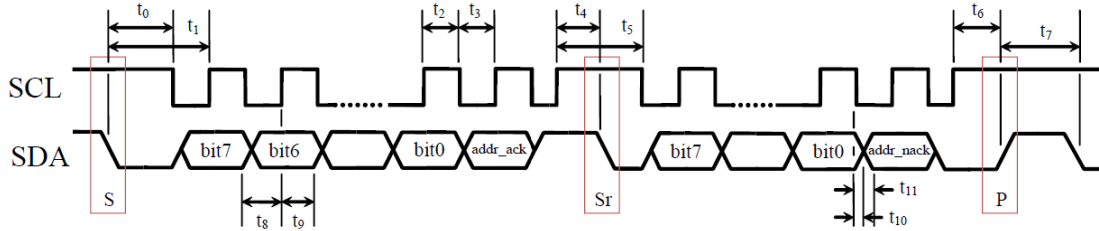

Number	Description	MIN	MAX	Units
t ₀	SDA LOW to SCL LOW transition (Start event)	50	-	ns
t ₁	SDA LOW to first SCL rising edge	100	-	ns
t ₂	SCL pulse width: HIGH	100	-	ns
t ₃	SCL pulse width: LOW	100	-	ns
t ₄	SCL HIGH before SDA falling edge (Start Repeated)	50	-	ns
t ₅	SCL pulse width: HIGH during a S/Sr/P event	100	-	ns
t ₆	SCL HIGH before SDA rising edge (Stop)	50	-	ns
t ₇	SDA pulse width: HIGH	25	-	ns
t ₈	SDA valid to SCL rising edge	50	-	ns
t ₉	SCL rising edge to SDA invalid	50	-	ns
t ₁₀	SCL falling edge to SDA valid (when slave is transmitting)	-	100	ns
t ₁₁	SCL falling edge to SDA invalid (when slave is transmitting)	0	-	ns
Note	Recommended I ² C CLK	2.5	-	μs

Table 10: I²C Timing (Fast Mode)

	± 1200uT Tri-axis Digital Magnetometer/ ± 2g/4g/8g/16g Tri-axis Digital Accelerometer Specifications	PART NUMBER: KMX62-1031 Rev. 4.0 20-Dec-2017
---	---	---

Power Modes

The KMX62 has five power modes: Off, Stand-by, Sleep, Low Power (RES = 00, 01) and High Resolution (RES = 10, 11). The part exists in one of these five modes at any given time. Off and Stand-by modes have very low current consumptions.

Power Mode	Bus State	IO_VDD	VDD	Function	Outputs
Off	-	OFF	OFF	No sensor activity	Not available
		ON	OFF		
		OFF	ON		
Stand-by	Active	ON	ON	Waiting activation command	Not available
Sleep	Active	ON	ON	Accelerometer active looking for motion wake up	Accel registers only – no buffer, no DRDY interrupt
<RES> = 00 or 01	Active	ON	ON	All functionalities available	All sensors available
<RES> = 10 or 11	Active	ON	ON	All functionalities available	All sensors available

Off mode

One or both power supplies (VDD or IO_VDD) are not powered. The sensor is completely inactive and not reporting or communicating. Bus communication actions of other devices are not disturbed if they are using the same bus interface as this component.

Initial Startup

The preferred startup sequence is to turn on IO_VDD before VDD, but if VDD is turned on first, the component will not affect the bus communications (no latch-up or other problems during engine system level wake-up).

Power On Reset (POR) is performed every time when:

1. IO_VDD supply is valid
 2. VDD power supply is going to valid level
- OR**
1. IO_VDD power supply is going to valid level
 2. VDD supply is valid

When POR occurs, the registers are loaded from OTP and the part is put into Stand-by mode.

	<p align="center">± 1200uT Tri-axis Digital Magnetometer/ ± 2g/4g/8g/16g Tri-axis Digital Accelerometer Specifications</p>	<p>PART NUMBER: KMX62-1031 Rev. 4.0 20-Dec-2017</p>
---	---	--

Stand-by mode

The primary function of the stand-by mode is to ensure fast wake-up to active mode and to minimize current consumption. This mode is set as default when both power supplies are applied and the POR function occurs. A Soft Reset command also performs the POR function and puts the part into Stand-by mode.

Stand-by mode is a low power waiting state for fast turn on time. Bus communication actions of other components are not disturbed if they are using the same bus. There is only one possible way to change to active mode – a register command from the external application processor via the I²C bus.

Sleep mode

While in sleep mode, the accelerometer is periodically taking a measurement to detect if there is any motion. Data in the accelerometer registers is being updated, however, there is no data ready interrupt being reported. Also, no data is being sent to the buffer.

Low Power (<RES> = 00 or 01) mode

Stand-by-mode can be changed to a Low Power mode by writing to register Control Register 2 or when a motion wake up event occurs.

Low power mode engages the full functionality of accelerometer and/or magnetometer measurements in a low power, low resolution mode (see *Table 15: Selected resolution range* for details). The host can change settings in the control register back to Stand-by mode for either or both the accelerometer and magnetometer. If enabled, the back to sleep function will put the part into the Sleep mode.

The host can also place the part into High Resolution (<RES> = 10 or 11) mode by writing to Control Register 2.

High Resolution (<RES> = 10 or 11) mode

Stand-by-mode can be changed to High Resolution mode by writing to register Control Register 2.

High Resolution mode engages the full functionality of accelerometer and/or magnetometer measurements in a higher power, higher resolution mode (see *Table 15: Selected resolution range* for details). The host can change settings in the control register back to Stand-by mode for either or both the accelerometer and magnetometer. If enabled, the back to sleep function will put the part into the Sleep mode.

The host can also place the part into Low Power (<RES> = 00 or 01) mode by writing to Control Register 2.



**± 1200uT Tri-axis Digital Magnetometer/
± 2g/4g/8g/16g Tri-axis Digital
Accelerometer Specifications**

PART NUMBER:

**KMX62-1031
Rev. 4.0
20-Dec-2017**

Embedded Registers

The KMX62 has 45 embedded 8-bit registers that are accessible by the user. This section contains the addresses for all embedded registers and describes bit functions of each register. Table 11 below provides a listing of the accessible 8-bit registers and their addresses.

Register Name	I ² C Address (Hex)	Type R/W	Register Name	I ² C Address (Hex)	Type R/W
WHO_AM_I	00h	R	AMI_CNTL1	2Fh	R/W
INS1	01h	R	AMI_CNTL2	30h	R/W
INS2	02h	R	AMI_CNTL3	31h	R/W
INS3	03h	R	MMI_CNTL1	32h	R/W
INL	05h	R	MMI_CNTL2	33h	R/W
ACCEL_XOUT_L	0Ah	R	MMI_CNTL3	34h	R/W
ACCEL_XOUT_H	0Bh	R	FFI_CNTL1	35h	R/W
ACCEL_YOUT_L	0Ch	R	FFI_CNTL2	36h	R/W
ACCEL_YOUT_H	0Dh	R	FFI_CNTL3	37h	R/W
ACCEL_ZOUT_L	0Eh	R	ODCNTL	38h	R/W
ACCEL_ZOUT_H	0Fh	R	CNTL1	39h	R/W
MAG_XOUT_L	10h	R	CNTL2	3Ah	R/W
MAG_XOUT_H	11h	R	COTR	3Ch	R
MAG_YOUT_L	12h	R	BUF_CTRL_1	77h	R/W
MAG_YOUT_H	13h	R	BUF_CTRL_2	78h	R/W
MAG_ZOUT_L	14h	R	BUF_CTRL_3	79h	R/W
MAG_ZOUT_H	15h	R	BUF_CLEAR	7Ah	W
TEMP_OUT_L	16h	R	BUF_STATUS_1	7Bh	R
TEMP_OUT_H	17h	R	BUF_STATUS_2	7Ch	R
INC1	2Ah	R/W	BUF_STATUS_3	7Dh	R
INC2	2Bh	R/W	BUF_READ	7Eh	R
INC3	2Ch	R/W			
INC4	2Dh	R/W			
INC5	2Eh	R/W			

Table 11: I²C Register Map



**± 1200uT Tri-axis Digital Magnetometer/
± 2g/4g/8g/16g Tri-axis Digital
Accelerometer Specifications**

PART NUMBER:

**KMX62-1031
Rev. 4.0
20-Dec-2017**

Register Descriptions

WHO_AM_I

This register is used for supplier recognition, as it is factory written to a known byte value. The default value is 0x18.

R	R	R	R	R	R	R	R	
WAI_MIR7	WAI_MIR6	WAI_MIR5	WAI_MIR4	WAI_MIR3	WAI_MIR2	WAI_MIR1	WAI_MIR0	Reset Value
Bit7	Bit6	Bit5	Bit4	Bit3	Bit2	Bit1	Bit0	00011000
Address: 0x00								

INS1 - Interrupt Source Register 1

This register tells which function caused an interrupt.

R	R	R	R	R	R	R	R	
INT	BFI	WMI	DRDY_A	DRDY_M	FFI	AMI	MMI	Reset Value
Bit7	Bit6	Bit5	Bit4	Bit3	Bit2	Bit1	Bit0	00000000
Address: 0x01								

INT reports the combined (OR) interrupt information of all enabled interrupt.
0= no interrupt event, 1= interrupt event has occurred.

BFI - indicates that the buffer is full. This bit is cleared when the data is read until the buffer is not full.

BFI = 0 – Buffer is not full

BFI = 1 – Buffer is full

WMI - indicates that user-defined buffer watermark has been reached. This bit is cleared when the data is read until the sample level in the buffer is smaller than the watermark threshold.

WMI = 0 – Buffer watermark not reached

WMI = 1 – Buffer watermark reached

DRDY_A - indicates that new acceleration data is available. This bit is cleared when the data is read or the interrupt release register (INL Register) is read.

DRDY_A = 0 – New acceleration data not available

DRDY_A = 1 – New acceleration data available



**± 1200uT Tri-axis Digital Magnetometer/
± 2g/4g/8g/16g Tri-axis Digital
Accelerometer Specifications**

PART NUMBER:

**KMX62-1031
Rev. 4.0
20-Dec-2017**

DRDY_M - indicates that new magnetometer data is available. This bit is cleared when the data is read or the interrupt release register (INL Register) is read.

DRDY_M = 0 – New magnetometer data not available

DRDY_M = 1 – New magnetometer data available

FFI – Free fall, this bit is cleared when the interrupt source latch register (INL Register) is read.

FFI = 1 – Free fall has activated the interrupt

FFI = 0 – No free fall

AMI – Accelerometer motion interrupt. This bit is cleared when the interrupt source latch register (INL) is read.

AMI = 1 – Accelerometer motion has activated the interrupt

AMI = 0 – No motion

MMI – Magnetometer motion interrupt. This bit is cleared when the interrupt source latch register (INL Register) is read.

MMI = 1 – Magnetometer motion has activated the interrupt

MMI = 0 – No motion

INS2 - Interrupt Source Register 2

This register reports axis and direction of the accelerometer motion that triggered the interrupt.

R	R	R	R	R	R	R	R	
X	X	AXNI	AXPI	AYNI	AYPI	AZNI	AZPI	Reset Value
Bit7	Bit6	Bit5	Bit4	Bit3	Bit2	Bit1	Bit0	00000000
Address: 0x02								

AXNI - x negative (x-)

AXPI - x positive (x+)

AYNI - y negative (y-)

AYPI - y positive (y+)

AZNI - z negative (z-)

AZPI - z positive (z+)



**± 1200uT Tri-axis Digital Magnetometer/
± 2g/4g/8g/16g Tri-axis Digital
Accelerometer Specifications**

PART NUMBER:

**KMX62-1031
Rev. 4.0
20-Dec-2017**

INS3 - Interrupt Source Register 3

The Interrupt Source Register 3 reports the axis and direction of the magnetometer motion that triggered the interrupt.

R	R	R	R	R	R	R	R	
X	X	MXNI	MXPI	MYNI	MYPI	MZNI	MZPI	Reset Value
Bit7	Bit6	Bit5	Bit4	Bit3	Bit2	Bit1	Bit0	00000000
Address: 0x03								

- MXNI*** - x negative (x-)
- MXPI*** - x positive (x+)
- MYNI*** - y negative (y-)
- MYPI*** - y positive (y+)
- MZNI*** - z negative (z-)
- MZPI*** - z positive (z+)

INL - Interrupt Latch Release

Latched interrupt source information (at INS1 and INS2) is cleared and physical interrupt latched pin is changed to its inactive state when this register is read. If an engine is configured as an unlatched interrupt and the current state is indicating an interrupt, this release will not clear the interrupt.

R	R	R	R	R	R	R	R	
X	X	X	X	X	X	X	X	Reset Value
Bit7	Bit6	Bit5	Bit4	Bit3	Bit2	Bit1	Bit0	00000000
Address: 0x05								



**± 1200uT Tri-axis Digital Magnetometer/
± 2g/4g/8g/16g Tri-axis Digital
Accelerometer Specifications**

PART NUMBER:

**KMX62-1031
Rev. 4.0
20-Dec-2017**

Accelerometer output

These registers contain 16-bits of valid acceleration data for each axis. The data is updated every user-defined ODR period as set by OSA<3:0> bits in ODCNTL register. The data is protected from overwrite during each read, and can be converted from digital counts to acceleration (g) per Figure 5 below. The register acceleration output binary data is represented in 16-bit 2's complement format resulting in the count range from -32768 to 32767.

16-bit Register Data (2's complement)	Equivalent Counts in decimal	Range = ±2g	Range = ±4g	Range = ±8g	Range = ±16g
0111 1111 1111 1111	32767	+1.99994g	+3.99988g	+7.99976g	+15.99951g
0111 1111 1111 1110	32766	+1.99988g	+3.99976g	+7.99951g	+15.99902g
...
0000 0000 0000 0001	1	+0.00006g	+0.00012g	+0.00024g	+0.00049g
0000 0000 0000 0000	0	0.00000g	0.00000g	0.00000g	0.00000g
1111 1111 1111 1111	-1	-0.00006g	-0.00012g	-0.00024g	-0.00049g
...
1000 0000 0000 0001	-32767	-1.99994g	-3.99988g	-7.99976g	-15.99951g
1000 0000 0000 0000	-32768	-2.00000g	-4.00000g	-8.00000g	-16.00000g

Figure 5: Acceleration (g) Calculation

ACCEL_XOUT_L

X-axis accelerometer output least significant byte. Data is updated at the ODR frequency determined by OSA bits in ODCNTL register.

R	R	R	R	R	R	R	R
ACC_X7	ACC_X6	ACC_X5	ACC_X4	ACC_X3	ACC_X2	ACC_X1	ACC_X0
Bit7	Bit6	Bit5	Bit4	Bit3	Bit2	Bit1	Bit0
Address: 0x0A							

ACCEL_XOUT_H

X-axis accelerometer output most significant byte. Data is updated at the ODR frequency determined by OSA bits in ODCNTL register.

R	R	R	R	R	R	R	R
ACC_X15	ACC_X14	ACC_X13	ACC_X12	ACC_X11	ACC_X10	ACC_X9	ACC_X8
Bit7	Bit6	Bit5	Bit4	Bit3	Bit2	Bit1	Bit0
Address: 0x0B							



**± 1200uT Tri-axis Digital Magnetometer/
± 2g/4g/8g/16g Tri-axis Digital
Accelerometer Specifications**

PART NUMBER:

**KMX62-1031
Rev. 4.0
20-Dec-2017**

ACCEL_YOUT_L

Y-axis accelerometer output least significant byte. Data is updated at the ODR frequency determined by OSA bits in ODCNTL register.

R	R	R	R	R	R	R	R
ACC_Y7	ACC_Y6	ACC_Y5	ACC_Y4	ACC_Y3	ACC_Y2	ACC_Y1	ACC_Y0
Bit7	Bit6	Bit5	Bit4	Bit3	Bit2	Bit1	Bit0
Address: 0x0C							

ACCEL_YOUT_H

Y-axis accelerometer output most significant byte. Data is updated at the ODR frequency determined by OSA bits in ODCNTL register.

R	R	R	R	R	R	R	R
ACC_Y15	ACC_Y14	ACC_Y13	ACC_Y12	ACC_Y11	ACC_Y10	ACC_Y9	ACC_Y8
Bit7	Bit6	Bit5	Bit4	Bit3	Bit2	Bit1	Bit0
Address: 0x0D							

ACCEL_ZOUT_L

Z-axis accelerometer output least significant byte. Data is updated at the ODR frequency determined by OSA bits in ODCNTL register.

R	R	R	R	R	R	R	R
ACC_Z7	ACC_Z6	ACC_Z5	ACC_Z4	ACC_Z3	ACC_Z2	ACC_Z1	ACC_Z0
Bit7	Bit6	Bit5	Bit4	Bit3	Bit2	Bit1	Bit0
Address: 0x0E							

ACCEL_ZOUT_H

Z-axis accelerometer output most significant byte. Data is updated at the ODR frequency determined by OSA bits in ODCNTL register.

R	R	R	R	R	R	R	R
ACC_Z15	ACC_Z14	ACC_Z13	ACC_Z12	ACC_Z11	ACC_Z10	ACC_Z9	ACC_Z8
Bit7	Bit6	Bit5	Bit4	Bit3	Bit2	Bit1	Bit0
Address: 0x0F							



**± 1200uT Tri-axis Digital Magnetometer/
± 2g/4g/8g/16g Tri-axis Digital
Accelerometer Specifications**

PART NUMBER:

**KMX62-1031
Rev. 4.0
20-Dec-2017**

Magnetometer output

These registers contain 16-bits of valid magnetic field data for each axis. The data is protected from overwrite during each read, and can be converted from digital counts to magnetic field strength (μT) per Figure 6 below.

16-bit Data	Magnetic field μT
0111 1111 1111 1111	+1199.96338 μT
0111 1111 1111 1110	+1199.92676 μT
...	...
...	...
0000 0000 0000 0001	+0.03662 μT
0000 0000 0000 0000	0 μT
1111 1111 1111 1111	-0.03662 μT
...	...
...	...
1000 0000 0000 0001	-1199.96338 μT
1000 0000 0000 0000	-1200.00000 μT

Figure 6: Magnetic field (μT) Calculation

MAG_XOUT_L

X-axis magnetometer output least significant byte. Data is updated at the ODR frequency determined by OSM bits in ODCNTL register.

R	R	R	R	R	R	R	R
MAG_X7	MAG_X6	MAG_X5	MAG_X4	MAG_X3	MAG_X2	MAG_X1	MAG_X0
Bit7	Bit6	Bit5	Bit4	Bit3	Bit2	Bit1	Bit0
Address: 0x10							

MAG_XOUT_H

X-axis magnetometer output most significant byte. Data is updated at the ODR frequency determined by OSM bits in ODCNTL register.

R	R	R	R	R	R	R	R
MAG_X15	MAG_X14	MAG_X13	MAG_X12	MAG_X11	MAG_X10	MAG_X9	MAG_X8
Bit7	Bit6	Bit5	Bit4	Bit3	Bit2	Bit1	Bit0
Address: 0x11							



**± 1200uT Tri-axis Digital Magnetometer/
± 2g/4g/8g/16g Tri-axis Digital
Accelerometer Specifications**

PART NUMBER:

**KMX62-1031
Rev. 4.0
20-Dec-2017**

MAG_YOUT_L

Y-axis magnetometer output least significant byte. Data is updated at the ODR frequency determined by OSM bits in ODCNTL register.

R	R	R	R	R	R	R	R
MAG_Y7	MAG_Y6	MAG_Y5	MAG_Y4	MAG_Y3	MAG_Y2	MAG_Y1	MAG_Y0
Bit7	Bit6	Bit5	Bit4	Bit3	Bit2	Bit1	Bit0
Address: 0x12							

MAG_YOUT_H

Y-axis magnetometer output most significant byte. Data is updated at the ODR frequency determined by OSM bits in ODCNTL register.

R	R	R	R	R	R	R	R
MAG_Y15	MAG_Y14	MAG_Y13	MAG_Y12	MAG_Y11	MAG_Y10	MAG_Y9	MAG_Y8
Bit7	Bit6	Bit5	Bit4	Bit3	Bit2	Bit1	Bit0
Address: 0x13							

MAG_ZOUT_L

Z-axis magnetometer output least significant byte. Data is updated at the ODR frequency determined by OSM bits in ODCNTL register.

R	R	R	R	R	R	R	R
MAG_Z7	MAG_Z6	MAG_Z5	MAG_Z4	MAG_Z3	MAG_Z2	MAG_Z1	MAG_Z0
Bit7	Bit6	Bit5	Bit4	Bit3	Bit2	Bit1	Bit0
Address: 0x14							

MAG_ZOUT_H

Z-axis magnetometer output most significant byte. Data is updated at the ODR frequency determined by OSM bits in ODCNTL register.

R	R	R	R	R	R	R	R
MAG_Z15	MAG_Z14	MAG_Z13	MAG_Z12	MAG_Z11	MAG_Z10	MAG_Z9	MAG_Z8
Bit7	Bit6	Bit5	Bit4	Bit3	Bit2	Bit1	Bit0
Address: 0x15							



**± 1200uT Tri-axis Digital Magnetometer/
± 2g/4g/8g/16g Tri-axis Digital
Accelerometer Specifications**

PART NUMBER:

**KMX62-1031
Rev. 4.0
20-Dec-2017**

Temperature Output

The temperature registers contain 16-bits of temperature data. If only register TEMP_OUT_H is used (8 bits), then the sensitivity can be considered as 1 count/°C. If both registers TEMP_OUT_H and TEMP_OUT_L are used (16 bits), then sensitivity can be considered as 256 counts/°C.

8-bit Register Data TEMP_OUT_H (2's complement)	Equivalent Counts in decimal	Temperature (°C)
0101 0101	85	+85 °C
...
0000 0001	1	+1 °C
0000 0000	0	0 °C
1111 1111	-1	-1 °C
...
1101 1000	-40	-40 °C

16-bit Register Data (2's complement)	Equivalent Counts in decimal	Temperature (°C)
0101 0101 0000 0000	21760	+85.000 °C
...
0000 0001 0000 0000	256	+1.0000 °C
...
0000 0000 0100 0000	64	+0.2500 °C
...
0000 0000 0000 0001	1	+0.0039 °C
0000 0000 0000 0000	0	0.0000 °C
1111 1111 1111 1111	-1	-0.0039 °C
...
1111 1111 1100 0000	-64	-0.2500 °C
...
1111 1111 0000 0000	-256	-1.0000 °C
...
1101 1000 0000 0000	-10240	-40.000 °C

Figure 7: Temperature (°C) Calculation



**± 1200uT Tri-axis Digital Magnetometer/
± 2g/4g/8g/16g Tri-axis Digital
Accelerometer Specifications**

PART NUMBER:

**KMX62-1031
Rev. 4.0
20-Dec-2017**

TEMP_OUT_L

Temperature sensor output least significant byte.

R	R	R	R	R	R	R	R
TEMP7	TEMP6	TEMP5	TEMP4	TEMP3	TEMP2	TEMP1	TEMP0
Bit7	Bit6	Bit5	Bit4	Bit3	Bit2	Bit1	Bit0
Address: 0x16							

TEMP_OUT_H

Temperature sensor output most significant byte.

R	R	R	R	R	R	R	R
TEMP15	TEMP14	TEMP13	TEMP12	TEMP11	TEMP10	TEMP9	TEMP8
Bit7	Bit6	Bit5	Bit4	Bit3	Bit2	Bit1	Bit0
Address: 0x17							

INC1 - Interrupt Control 1

This register controls routing of an interrupt reporting to physical interrupt pin GPIO1.

R/W	R/W	R/W	R/W	R/W	R/W	R/W	R/W	
X	BF11	WMI1	DRDY_A1	DRDY_M1	FF11	AMI1	MMI1	Reset Value
Bit7	Bit6	Bit5	Bit4	Bit3	Bit2	Bit1	Bit0	00000000
Address: 0x2A								

BF11 - Buffer full interrupt reported on GPIO1

BF11 = 0 – disable

BF11 = 1 – enable

WMI1 - Watermark interrupt reported on GPIO1

WMI1 = 0 – disable

WMI1 = 1 – enable

DRDY_A1 - Accelerometer Data ready reported on GPIO1

DRDY_A1 = 0 – disable

DRDY_A1 = 1 – enable

DRDY_M1 - Magnetometer Data ready reported on GPIO1

DRDY_M1 = 0 – disable

DRDY_M1 = 1 – enable

FF11 - Accelerometer Free fall interrupt reported on GPIO1

FF11 = 0 – disable

FF11 = 1 – enable



**± 1200uT Tri-axis Digital Magnetometer/
± 2g/4g/8g/16g Tri-axis Digital
Accelerometer Specifications**

PART NUMBER:

**KMX62-1031
Rev. 4.0
20-Dec-2017**

AMI1 - Accelerometer motion interrupt reported on GPIO1

AMI1 = 0 – disable

AMI1 = 1 – enable

MMI1 - Magnetometer motion interrupt reported on GPIO1

MMI1 = 0 – disable

MMI1 = 1 – enable

INC2 - Interrupt Control 2

This register controls routing of an interrupt reporting to physical interrupt pin GPIO2.

R/W	R/W	R/W	R/W	R/W	R/W	R/W	R/W	
X	BFI2	WMI2	DRDY_A2	DRDY_M2	FFI2	AMI2	MMI2	Reset Value
Bit7	Bit6	Bit5	Bit4	Bit3	Bit2	Bit1	Bit0	00000000
Address: 0x2B								

BFI2 - Buffer full interrupt reported on GPIO2

BFI2 = 0 – disable

BFI2 = 1 – enable

WMI2 - Watermark interrupt reported on GPIO2

WMI2 = 0 – disable

WMI2 = 1 – enable

DRDY_A2 - Accelerometer Data ready reported on GPIO2

DRDY_A2 = 0 – disable

DRDY_A2 = 1 – enable.

DRDY_M2 - Magnetometer Data ready reported on GPIO2

DRDY_M2 = 0 – disable

DRDY_M2 = 1 – enable

FFI2 - Accelerometer Free fall interrupt reported on GPIO2

FFI2 = 0 – disable

FFI2 = 1 – enable

AMI2 - Accelerometer motion interrupt reported on GPIO2

AMI2 = 0 – disable

AMI2 = 1 – enable

MMI2 - Magnetometer motion interrupt reported on GPIO2

MMI2 = 0 – disable

MMI2 = 1 – enable



**± 1200uT Tri-axis Digital Magnetometer/
± 2g/4g/8g/16g Tri-axis Digital
Accelerometer Specifications**

PART NUMBER:

**KMX62-1031
Rev. 4.0
20-Dec-2017**

INC3 – Interrupt Control 3

This register controls the GPIO pin configuration.

R/W	R/W	R/W	R/W	R/W	R/W	R/W	R/W	Reset Value
IED2	IEA2	IEL2<1>	IEL2<0>	IED1	IEA1	IEL1<1>	IEL1<0>	10001000
Bit7	Bit6	Bit5	Bit4	Bit3	Bit2	Bit1	Bit0	
Address: 0x2C								

IED2 – Interrupt pin drive options for GPIO2

IED2 = 0 – push-pull
IED2 = 1 – open-drain

IEA2 - Interrupt active level control for interrupt GPIO2

IEA2 = 0 – active LOW
IEA2 = 1 – active HIGH

IEL2 <1:0>- Interrupt latch control for interrupt GPIO2

IEL2 = 0,0 – latched/unlatched. Unlatched feature is available for FFI, MMI, and AMI.
IEL2 = 0,1 – pulsed. In pulse mode, the pulse width is 50µs.
IEL2 = 1, X – trigger input for FIFO

IED1 – Interrupt pin drive options for GPIO1

IED1 = 0 – push-pull
IED1 = 1 – open-drain

IEA1 - Interrupt active level control for interrupt GPIO1

IEA1 = 0 – active LOW
IEA1 = 1 – active HIGH

IEL1 <1:0>- Interrupt latch control for interrupt GPIO1

IEL1 = 0,0 – latched/unlatched. Unlatched feature is available for FFI, MMI, and AMI.
IEL1 = 0,1 – pulsed. In pulse mode, the pulse width is 50µs.
IEL1 = 1, X – trigger input for FIFO

IED#	IEA#	IEL#<1:0>	BFI#	WMI#	DRDY_A#	DRDY_M#	FFI#	MMI#	AMI#	GPIO state
0	0	0,0	0	0	0	0	0	0	0	The GPIO pin is held HIGH
0	0	0,1	0	0	0	0	0	0	0	The GPIO pin is held HIGH
0	1	0,0	0	0	0	0	0	0	0	The GPIO pin is held LOW
0	1	0,1	0	0	0	0	0	0	0	The GPIO pin is held LOW
1	0	0,0	0	0	0	0	0	0	0	The GPIO pin is high impedance
1	0	0,1	0	0	0	0	0	0	0	The GPIO pin is high impedance
1	1	0,0	0	0	0	0	0	0	0	The GPIO pin is held LOW
1	1	0,1	0	0	0	0	0	0	0	The GPIO pin is held LOW
X	X	1,X	X	X	X	X	X	X	X	The GPIO pin is configured as an input for FIFO trigger. If both GPIO pins are trigger, the signals are OR'ed.



**± 1200uT Tri-axis Digital Magnetometer/
± 2g/4g/8g/16g Tri-axis Digital
Accelerometer Specifications**

PART NUMBER:

**KMX62-1031
Rev. 4.0
20-Dec-2017**

INC4 - Interrupt Control 4

This register controls which accelerometer axis and direction of detected motion can cause an interrupt.

R/W	R/W	R/W	R/W	R/W	R/W	R/W	R/W	
X	X	AXNIE	AXPIE	AYNIE	AYPIE	AZNIE	AZPIE	Reset Value
Bit7	Bit6	Bit5	Bit4	Bit3	Bit2	Bit1	Bit0	00111111
Address: 0x2D								

- AXNIE** - x negative (x-) accelerometer mask for AMI, 0=disable, 1=enable.
- AXPIE** - x positive (x+) accelerometer mask for AMI, 0=disable, 1=enable.
- AYNIE** - y negative (y-) accelerometer mask for AMI, 0=disable, 1=enable.
- AYPIE** - y positive (y+) accelerometer mask for AMI, 0=disable, 1=enable.
- AZNIE** - z negative (z-) accelerometer mask for AMI, 0=disable, 1=enable.
- AZPIE** - z positive (z+) accelerometer mask for AMI, 0=disable, 1=enable.

INC5 - Interrupt Control 5

This register controls which magnetometer axis and direction of detected motion can cause an interrupt.

R/W	R/W	R/W	R/W	R/W	R/W	R/W	R/W	
X	X	MXNIE	MXPIE	MYNIE	MYPIE	MZNIE	MZPIE	Reset Value
Bit7	Bit6	Bit5	Bit4	Bit3	Bit2	Bit1	Bit0	00111111
Address: 0x2E								

- MXNIE** - x negative (x-) magnetometer mask for MMI, 0=disable, 1=enable.
- MXPIE** - x positive (x+) magnetometer mask for MMI, 0=disable, 1=enable.
- MYNIE** - y negative (y-) magnetometer mask for MMI, 0=disable, 1=enable.
- MYPIE** - y positive (y+) magnetometer mask for MMI, 0=disable, 1=enable.
- MZNIE** - z negative (z-) magnetometer mask for MMI, 0=disable, 1=enable.
- MZPIE** - z positive (z+) magnetometer mask for MMI, 0=disable, 1=enable.

	<p align="center">± 1200uT Tri-axis Digital Magnetometer/ ± 2g/4g/8g/16g Tri-axis Digital Accelerometer Specifications</p>	<p>PART NUMBER: KMX62-1031 Rev. 4.0 20-Dec-2017</p>
---	---	--

AMI_CNTL1 - Accelerometer Motion Control 1

This register controls the accelerometer motion interrupt threshold for the wake up engine.

R/W	R/W	R/W	R/W	R/W	R/W	R/W	R/W	
AMITH7	AMITH6	AMITH5	AMITH4	AMITH3	AMITH2	AMITH1	AMITH0	Reset Value
Bit7	Bit6	Bit5	Bit4	Bit3	Bit2	Bit1	Bit0	00000000
Address: 0x2F								

AMITH<7:0> - Accelerometer motion interrupt threshold. This value is compared to the top 8 bits of the accelerometer 8g output.

AMI_CNTL2 - Accelerometer Motion Control 2

This register controls the counter setting for the accelerometer motion wake up engine.

R/W	R/W	R/W	R/W	R/W	R/W	R/W	R/W	
AMICT7	AMICT6	AMICT5	AMICT4	AMICT3	AMICT2	AMICT1	AMICT0	Reset Value
Bit7	Bit6	Bit5	Bit4	Bit3	Bit2	Bit1	Bit0	00000000
Address: 0x30								

AMICT<7:0> - Accelerometer motion interrupt counter. Every count is calculated as 1/ODR delay period, where the Motion Interrupt ODR is user-defined per the OAMI bits in AMI_CNTL3. A new state must be valid as many measurement periods before the change is accepted. Note that to properly change the value of this register, the accelerometer should be in standby.



**± 1200uT Tri-axis Digital Magnetometer/
± 2g/4g/8g/16g Tri-axis Digital
Accelerometer Specifications**

PART NUMBER:

**KMX62-1031
Rev. 4.0
20-Dec-2017**

AMI_CNTL3 - Accelerometer Motion Control 3

This register has control settings for the accelerometer motion interrupt function.

R/W	R/W	R/W	R/W	R/W	R/W	R/W	R/W	Reset Value
AMI_EN	AMIUL	X	X	X	OAMI2	OAMI1	OAMI0	00000000
Bit7	Bit6	Bit5	Bit4	Bit3	Bit2	Bit1	Bit0	
Address: 0x31								

AMI_EN - Accelerometer motion interrupt engine enable

AMI_EN = 0 – disabled

AMI_EN = 1 – enabled

AMIUL - Accelerometer Motion Interrupt latch/un-latch control for interrupt GPIO1/2

AMIUL = 0 – latched

AMIUL = 1 – un-latched

OAMI<2:0> - Output Data Rate at which the accelerometer motion detection performs its function.

OAMI<2>	OAMI <1>	OAMI <0>	Output Data Rate (Hz)
0	0	0	0.781
0	0	1	1.563
0	1	0	3.125
0	1	1	6.25
1	0	0	12.5
1	0	1	25
1	1	0	50
1	1	1	100



**± 1200uT Tri-axis Digital Magnetometer/
± 2g/4g/8g/16g Tri-axis Digital
Accelerometer Specifications**

PART NUMBER:

**KMX62-1031
Rev. 4.0
20-Dec-2017**

MMI_CNTL1 - Magnetometer Motion Control 1

This register controls the magnetometer motion interrupt threshold for the wake up engine.

R/W	R/W	R/W	R/W	R/W	R/W	R/W	R/W	
MMITH7	MMITH6	MMITH5	MMITH4	MMITH3	MMITH2	MMITH1	MMITH0	Reset Value
Bit7	Bit6	Bit5	Bit4	Bit3	Bit2	Bit1	Bit0	00000000
Address: 0x32								

MMITH<7:0> - Magnetometer motion interrupt threshold. This value is compared to the top 8 bits of the magnetometer 1200µT output.

MMI_CNTL2 - Magnetometer Motion Control 2

This register controls the counter setting for the magnetometer motion wake up engine.

R/W	R/W	R/W	R/W	R/W	R/W	R/W	R/W	
MMICT7	MMICT6	MMICT5	MMICT4	MMICT3	MMICT2	MMICT1	MMICT0	Reset Value
Bit7	Bit6	Bit5	Bit4	Bit3	Bit2	Bit1	Bit0	00000000
Address: 0x33								

MMICT<7:0> - Magnetometer motion interrupt counter. Every count is calculated as 1/ODR delay period where the ODR is user-defined per the OMMI bits in MMI_CNTL3.



**± 1200uT Tri-axis Digital Magnetometer/
± 2g/4g/8g/16g Tri-axis Digital
Accelerometer Specifications**

PART NUMBER:

**KMX62-1031
Rev. 4.0
20-Dec-2017**

MMI_CNTL3 - Magnetometer Motion Control 3

This register has control settings for the magnetometer motion interrupt function.

R/W	R/W	R/W	R/W	R/W	R/W	R/W	R/W	Reset Value
MMI_EN	MMIUL	X	X	X	OMMI2	OMMI1	OMMI0	00000000
Bit7	Bit6	Bit5	Bit4	Bit3	Bit2	Bit1	Bit0	
Address: 0x34								

MMI_EN - Magnetometer motion interrupt engine enable

MMI_EN = 0 – disabled

MMI_EN = 1 – enabled

MMIUL - Magnetometer Motion Interrupt latch/un-latch control for interrupt GPIO1/2

MMIUL = 0 – latched

MMIUL = 1 – un-latched

OMMI<2:0> - Output Data Rate at which the magnetometer motion detection performs its function.

OMMI<2>	OMMI <1>	OMMI <0>	Output Data Rate (Hz)
0	0	0	0.781
0	0	1	1.563
0	1	0	3.125
0	1	1	6.25
1	0	0	12.5
1	0	1	25
1	1	0	50
1	1	1	100



**± 1200uT Tri-axis Digital Magnetometer/
± 2g/4g/8g/16g Tri-axis Digital
Accelerometer Specifications**

PART NUMBER:

**KMX62-1031
Rev. 4.0
20-Dec-2017**

FFI_CNTL1 - Free Fall Control 1

This register has control settings for the free fall interrupt function.

R/W	R/W	R/W	R/W	R/W	R/W	R/W	R/W	
FFITH7	FFITH6	FFITH5	FFITH4	FFITH3	FFITH2	FFITH1	FFITH0	Reset Value
Bit7	Bit6	Bit5	Bit4	Bit3	Bit2	Bit1	Bit0	00000000
Address: 0x35								

***FFITH<7:0>** - Accelerometer free fall interrupt threshold. This value is compared to the top 8 bits of the accelerometer 8g output.*

FFI_CNTL2 - Free Fall Control 2

This register has control settings for the free fall interrupt function.

R/W	R/W	R/W	R/W	R/W	R/W	R/W	R/W	
FFICT7	FFICT6	FFICT5	FFICT4	FFICT3	FFICT2	FFICT1	FFICT0	Reset Value
Bit7	Bit6	Bit5	Bit4	Bit3	Bit2	Bit1	Bit0	00000000
Address: 0x36								

***FFICT<7:0>** - Accelerometer free fall interrupt counter. Every count is calculated as 1/ODR delay period.*



**± 1200uT Tri-axis Digital Magnetometer/
± 2g/4g/8g/16g Tri-axis Digital
Accelerometer Specifications**

PART NUMBER:

**KMX62-1031
Rev. 4.0
20-Dec-2017**

FFI_CNTL3 - Free Fall Control 3

This register has control settings for the free fall interrupt function.

R/W	R/W	R/W	R/W	R/W	R/W	R/W	R/W	
FFI_EN	FFIUL	X	X	DCRM	OFFI2	OFFI1	OFFI0	Reset Value
Bit7	Bit6	Bit5	Bit4	Bit3	Bit2	Bit1	Bit0	00000000
Address: 0x37								

FFI_EN - Accelerometer free fall engine enable

FFI_EN = 0 – disabled

FFI_EN = 1 – enabled

FFIUL - Accelerometer Free Fall Interrupt latch/un-latch control for interrupt GPIO1/2

FFIUL = 0 – latched

FFIUL = 1 – un-latched

DCRM – Debounce methodology control

DCRM = 0 - count up/down

DCRM = 1- count up/reset.

OFFI<2:0> - Output Data Rate at which the free fall detection performs its function

OFFI<2>	OFFI <1>	OFFI <0>	Output Data Rate (Hz)
0	0	0	12.5
0	0	1	25
0	1	0	50
0	1	1	100
1	0	0	200
1	0	1	400
1	1	0	800
1	1	1	1600



**± 1200uT Tri-axis Digital Magnetometer/
± 2g/4g/8g/16g Tri-axis Digital
Accelerometer Specifications**

PART NUMBER:

**KMX62-1031
Rev. 4.0
20-Dec-2017**

ODCNTL - Output Data Control Register

Output data control register

R/W	R/W	R/W	R/W	R/W	R/W	R/W	R/W	
OSM3	OSM2	OSM1	OSM0	OSA3	OSA2	OSA1	OSA0	Reset Value
Bit7	Bit6	Bit5	Bit4	Bit3	Bit2	Bit1	Bit0	00100010
Address: 0x38								

OSM<3:0> - Rate at which data samples from the magnetometer (and temperature sensor if enabled) will be updated in the output data registers.

OSM<3>	OSM<2>	OSM<1>	OSM<0>	Output Data Rate (Hz)
0	0	0	0	12.5**
0	0	0	1	25**
0	0	1	0	50**
0	0	1	1	100**
0	1	0	0	200**
0	1	0	1	400*
0	1	1	0	800
0	1	1	1	1600
1	0	0	0	0.781**
1	0	0	1	1.563**
1	0	1	0	3.125**
1	0	1	1	6.25**

Table 12: Magnetometer Output Data Rates (ODR)



**± 1200uT Tri-axis Digital Magnetometer/
± 2g/4g/8g/16g Tri-axis Digital
Accelerometer Specifications**

PART NUMBER:

**KMX62-1031
Rev. 4.0
20-Dec-2017**

OSA<3:0> - Rate at which data samples from the accelerometer will be updated in the output data registers.

OSA<3>	OSA<2>	OSA<1>	OSA<0>	Output Data Rate (Hz)
0	0	0	0	12.5**
0	0	0	1	25**
0	0	1	0	50**
0	0	1	1	100**
0	1	0	0	200**
0	1	0	1	400*
0	1	1	0	800
0	1	1	1	1600
1	0	0	0	0.781**
1	0	0	1	1.563**
1	0	1	0	3.125**
1	0	1	1	6.25**

Table 13: Accelerometer Output Data Rates (ODR)

Note: The FIFO buffer will be updated at the faster of the two output data rates (OSM or OSA).

* RES<0,0> available, all others will default to full power mode.

** RES<0,0> and RES<0,1> available, all others will default to full power mode.

Before changing the ODR of a sensor, both sensors should be in stand-by. Write the new ODR value(s) to ODCNTL, and then enable the sensor(s).

	± 1200uT Tri-axis Digital Magnetometer/ ± 2g/4g/8g/16g Tri-axis Digital Accelerometer Specifications	PART NUMBER: KMX62-1031 Rev. 4.0 20-Dec-2017
---	---	---

CNTL1 - Control Register 1

Control register that controls the main feature set.

R/W	R/W	R/W	R/W	R/W	R/W	R/W	R/W	
SRST	STEN	STPOL	RESERVED	COTC	RESERVED	X	X	Reset Value
Bit7	Bit6	Bit5	Bit4	Bit3	Bit2	Bit1	Bit0	00000000
Address: 0x39								

SRST – The Software Reset bit initiates software reset, which performs the RAM reboot routine. This bit will remain 1 until the RAM reboot routine is finished. Please refer to Technical Note [TN005 Power-On Procedure](#) for more information on software reset.

SRST = 0 – no action

SRST = 1 – start RAM reboot routine

STEN - ST enable. This bit enables the self-test mode that will produce a change in both the accelerometer and magnetometer transducers and can be measured in the output registers.

STEN = 0 – ST is disabled

STEN = 1 – ST is enabled

STPOL – Accelerometer and Magnetometer ST polarity.

STPOL = 0 – ST polarity is positive

STPOL = 1 – ST polarity is negative

COTC – The Command Test Control bit is used to verify proper ASIC functionality.

COTC = 0 – no action

COTC = 1 – sets COTR register to 0xAA. When COTR register is then read, sets COTC bit to 0 and sets COTR register to 0x55.

RESERVED – the setting of reserved bits should not be altered.



**± 1200uT Tri-axis Digital Magnetometer/
± 2g/4g/8g/16g Tri-axis Digital
Accelerometer Specifications**

PART NUMBER:

**KMX62-1031
Rev. 4.0
20-Dec-2017**

CNTL2 - Control Register 2

This register is used to enable and disable the sensors as well as to set their operation ranges.

R/W	R/W	R/W	R/W	R/W	R/W	R/W	R/W	
X	TEMP_EN	GSEL1	GSEL0	RES1	RES0	MAG_EN	ACCEL_EN	Reset Value
Bit7	Bit6	Bit5	Bit4	Bit3	Bit2	Bit1	Bit0	00000000
Address: 0x3A								

TEMP_EN controls the operating mode of the KMX62's temperature sensors. **MAG_EN** must also be enabled for temperature data to be converted. Output data rate is locked to the magnetometer's Output Data Rate as set by OSM<3:0> bits in ODCNTL register.

TEMP_EN = 0 – stand-by mode

TEMP_EN = 1 – operating mode. Magnetometer and temperature output registers are updated at the selected output data rate.

GSEL<1, 0> selects the acceleration range of the accelerometer outputs.

GSEL<1>	GSEL<0>	Range
0	0	±2g
0	1	±4g
1	0	±8g
1	1	±16g

Table 14: Selected Acceleration Range

RES<1, 0> selects the resolution of both sensors.

RES<1>	RES<0>	Accelerometer over sample	Magnetometer over sample
0	0	4	2
0	1	32	16
1	0	maximum	maximum
1	1	maximum	maximum

Table 15: Selected resolution range

MAG_EN controls the operating mode of the KMX62's magnetometer sensor.

MAG_EN = 0 – stand-by mode.

MAG_EN = 1 – operating mode. Magnetometer output registers are updated at the selected output data rate.

	<p align="center">± 1200uT Tri-axis Digital Magnetometer/ ± 2g/4g/8g/16g Tri-axis Digital Accelerometer Specifications</p>	<p>PART NUMBER: KMX62-1031 Rev. 4.0 20-Dec-2017</p>
---	---	---

ACCEL_EN controls the operating mode of the KMX62's accelerometer
ACCEL_EN = 0 – stand-by mode.
*ACCEL_EN = 1 – operating mode. Accelerometer output registers are updated at the
selected output data rate.*

COTR - Command Test Response

The Command Test Response (COTR) register is used to verify proper integrated circuit functionality. The value of this register will change from a default value of 0x55 to 0xAA when COTC bit in CNTL1 register is set. After reading 0xAA from this register, the byte value returns to the default value of 0x55 and COTC bit in CNTL1 register is cleared.

R	R	R	R	R	R	R	R	
COTR7	COTR6	COTR5	COTR4	COTR3	COTR2	COTR1	COTR0	Reset Value
Bit7	Bit6	Bit5	Bit4	Bit3	Bit2	Bit1	Bit0	01010101
Address: 0x3C								



**± 1200uT Tri-axis Digital Magnetometer/
± 2g/4g/8g/16g Tri-axis Digital
Accelerometer Specifications**

PART NUMBER:

**KMX62-1031
Rev. 4.0
20-Dec-2017**

BUF_CTRL_1,2,3

These registers control the buffer sample buffer operation.

R/W	R/W	R/W	R/W	R/W	R/W	R/W	R/W	
SMT_TH7	SMT_TH6	SMT_TH5	SMT_TH4	SMT_TH3	SMT_TH2	SMT_TH1	SMT_TH0	Reset Value
Bit7	Bit6	Bit5	Bit4	Bit3	Bit2	Bit1	Bit0	00000000
Address: 0x77								BUF_CTRL_1

R/W	R/W	R/W	R/W	R/W	R/W	R/W	R/W	
X	X	X	X	X	BUF_M1	BUF_M0	SMT_TH8	Reset Value
Bit7	Bit6	Bit5	Bit4	Bit3	Bit2	Bit1	Bit0	00000000
Address: 0x78								BUF_CTRL_2

R/W	R/W	R/W	R/W	R/W	R/W	R/W	R/W	
BFI_EN	BUF_AX	BUF_AY	BUF_AZ	BUF_MX	BUF_MY	BUF_MZ	BUF_TEMP	Reset Value
Bit7	Bit6	Bit5	Bit4	Bit3	Bit2	Bit1	Bit0	00000000
Address: 0x79								BUF_CTRL_3

SMP_TH<8:0> Sample Threshold - determines the number of data bytes that will trigger a watermark interrupt or will be saved prior to a trigger event. The maximum number of data bytes is 384 (example - 32 samples of 3 axes of accel and 3 axes of mag by 2 bytes per axis).

BUF_M<1:0> - selects the operating mode of the sample buffer

BUF_M<1>	BUF_M<0>	Mode	Description	Sample Threshold Operation
0	0	FIFO	The buffer collects 384 bytes of data until full, collecting new data only when the buffer is not full.	Specifies how many buffer samples are needed to trigger a watermark interrupt.
0	1	Stream	The buffer holds the last 384 bytes of data. Once the buffer is full, the oldest data is discarded to make room for newer data.	Specifies how many buffer samples are needed to trigger a watermark interrupt.
1	0	Trigger	When a trigger event occurs (interrupt is caused by one of the digital engines or when a logic HIGH signal occurs on the TRIG pin), the buffer holds the last data set of SMP_TH[8:0] samples before the trigger event and then continues to collect data until full. New data is collected only when the buffer is not full.	Specifies how many buffer samples before the trigger event are retained in the buffer.
1	1	FILO	The buffer holds the last 384 bytes of data. Once the buffer is full, the oldest data is discarded to make room for newer data. Reading from the buffer in this mode will return the most recent data first.	Specifies how many buffer samples are needed to trigger a watermark interrupt.



**± 1200uT Tri-axis Digital Magnetometer/
± 2g/4g/8g/16g Tri-axis Digital
Accelerometer Specifications**

PART NUMBER:

**KMX62-1031
Rev. 4.0
20-Dec-2017**

BFI_EN controls the buffer full interrupt

BFI_EN = 0 – the buffer full interrupt (BFI) is disabled

BFI_EN = 1 – the buffer full interrupt (BFI) will be triggered when the buffer is full

BUF_(AX, AY, AZ, MX, MY, MZ, TEMP) controls the data to be buffered.

BUF_(AX, AY, AZ, MX, MY, MZ, TEMP) = 0 – indicates data is not buffered

BUF_(AX, AY, AZ, MX, MY, MZ, TEMP) = 1 – indicates data is buffered

BUF_CLEAR

Latched buffer status information and the entire sample buffer are cleared when any data is written to this register.

W	W	W	W	W	W	W	W	
BUFCLR7	BUFCLR6	BUFCLR5	BUFCLR4	BUFCLR3	BUFCLR2	BUFCLR1	BUFCLR0	
Bit7	Bit6	Bit5	Bit4	Bit3	Bit2	Bit1	Bit0	
Address: 0x7A								

BUF_STATUS_1,2,3

This register reports the status of the sample buffer.

R	R	R	R	R	R	R	R	R
SMP_LEV7	SMP_LEV6	SMP_LEV5	SMP_LEV4	SMP_LEV3	SMP_LEV2	SMP_LEV1	SMP_LEV0	Reset Value
Bit7	Bit6	Bit5	Bit4	Bit3	Bit2	Bit1	Bit0	00000000
Address: 0x7B								BUF_STATUS_1

R	R	R	R	R	R	R	R	R
SMP_PAST5	SMP_PAST4	SMP_PAST3	SMP_PAST2	SMP_PAST1	SMP_PAST0	BUF_TRIG	SMP_LEV8	Reset Value
Bit7	Bit6	Bit5	Bit4	Bit3	Bit2	Bit1	Bit0	00000000
Address: 0x7C								BUF_STATUS_2

R	R	R	R	R	R	R	R	R
SMP_PAST13	SMP_PAST12	SMP_PAST11	SMP_PAST10	SMP_PAST9	SMP_PAST8	SMP_PAST7	SMP_PAST6	Reset Value
Bit7	Bit6	Bit5	Bit4	Bit3	Bit2	Bit1	Bit0	00000000
Address: 0x7D								BUF_STATUS_3



**± 1200uT Tri-axis Digital Magnetometer/
± 2g/4g/8g/16g Tri-axis Digital
Accelerometer Specifications**

PART NUMBER:

**KMX62-1031
Rev. 4.0
20-Dec-2017**

SMP_LEV<8:0> Sample Level; reports the number of data bytes that have been stored in the sample buffer. If this register reads 0, no data has been stored in the buffer. If the buffer data is read past this level the part will return 32,767 (maximum value).

Buffered Outputs (e.g. AX, AY, AZ, MX, MY, MZ, TEMP)	Maximum sets	Maximum bytes
1	192	384
2	96	384
3	64	384
4	48	384
5	38	380
6	32	384
7	27	378

BUF_TRIG reports the status of the buffer's trigger function if this mode has been selected. When using trigger mode, a buffer read should only be performed after a trigger event.

SMP_PAST<13:0> Sample overflow; reports the number of data bytes that have been missed since the sample buffer was filled. If this register reads 0, the buffer has not overflowed. This is cleared for "BUF_CLEAR" command and when the data is read from "BUF_READ"

BUF_READ

Data in the buffer can be read according to the BUF_M settings in BUF_CTRL2. More samples can be retrieved by continuing to toggle SCL after the read command is executed. Data should be read using an auto-increment. Additional samples cannot be written to the buffer while data is being read from the buffer using an auto-increment mode. Output data is in 2's Complement format.

R	R	R	R	R	R	R	R
BUF7	BUF6	BUF5	BUF4	BUF3	BUF2	BUF1	BUF0
Bit7	Bit6	Bit5	Bit4	Bit3	Bit2	Bit1	Bit0
Address: 0x7E							

	<p align="center">± 1200uT Tri-axis Digital Magnetometer/ ± 2g/4g/8g/16g Tri-axis Digital Accelerometer Specifications</p>	<p>PART NUMBER: KMX62-1031 Rev. 4.0 20-Dec-2017</p>
---	---	--

Embedded Applications

Accelerometer Motion Interrupt Feature

The Accelerometer Motion Interrupt feature of the KMX62 reports qualified changes in the high-pass filtered acceleration based on the Accelerometer Motion Interrupt Threshold (AMITH). If the high-pass filtered acceleration on any axis is greater than the user-defined Accelerometer Motion Interrupt Threshold (AMITH), the device has transitioned from an inactive state to an active state. Equation 1 shows how to calculate the AMITH register value for a desired wake-up threshold. The wake-up engine function is independent of the user selected g-range and resolution.

$$\text{AMITH (counts)} = \text{Wake-Up Threshold (g)} \times 16 \text{ (counts/g)}$$

Equation 1: Accelerometer Wake-Up Threshold

An 8-bit raw unsigned value represents a counter that permits the user to qualify each active/inactive state change. Note that Accelerometer Motion Interrupt Counter (AMICT) count value qualifies 1 (one) user-defined Wake-up Function ODR period as set by OAMI<2:0> bits in AMI_CNTL3 register. Equation 2 shows how to calculate the AMICT value for a desired wake-up delay time.

$$\text{AMICT (counts)} = \text{Wake-Up Delay Time (sec)} \times \text{Wake-up Function ODR (Hz)}$$

Equation 2: Accelerometer Wake-Up Delay Time

The latched accelerometer motion interrupt response algorithm works as following: while the part is in inactive state, the algorithm evaluates differential measurement between each new acceleration data point with the preceding one and evaluates it against the Activity Threshold (AMITH). When the differential measurement is greater than AMITH, the Accelerometer Motion Interrupt Counter (AMICT) starts the count. Differential measurements are now calculated based on the difference between the current acceleration and the acceleration when the counter started. The part will report that motion has occurred at the end of the count assuming each differential measurement has remained above the threshold. If at any moment during the count the differential measurement falls below the threshold, the counter will stop the count and the part will remain in inactive state.

To illustrate how the algorithm works, consider the Figure 8 below that shows the latched response of the motion detection algorithm with the Accelerometer Motion Interrupt Counter (AMICT) set to 10 counts. Note how the difference between the acceleration sample marked in red and the one marked in green resulted in a differential measurement represented with orange bar being above the Activity Threshold (AMITH). At this point, the Accelerometer Motion Interrupt Counter (AMICT) begins to count number of counts stored in AMI_CNTL2 register and the wake-up algorithm will evaluate the difference between each new acceleration measurement and the measurement marked in green that will remain a reference measurement for the duration of the counter count. At the end of the count, assuming all differential measurements were larger than Activity Threshold (AMITH), as is the case in the example showed in Figure 8 a motion event will be reported.



**± 1200uT Tri-axis Digital Magnetometer/
± 2g/4g/8g/16g Tri-axis Digital
Accelerometer Specifications**

PART NUMBER:

**KMX62-1031
Rev. 4.0
20-Dec-2017**

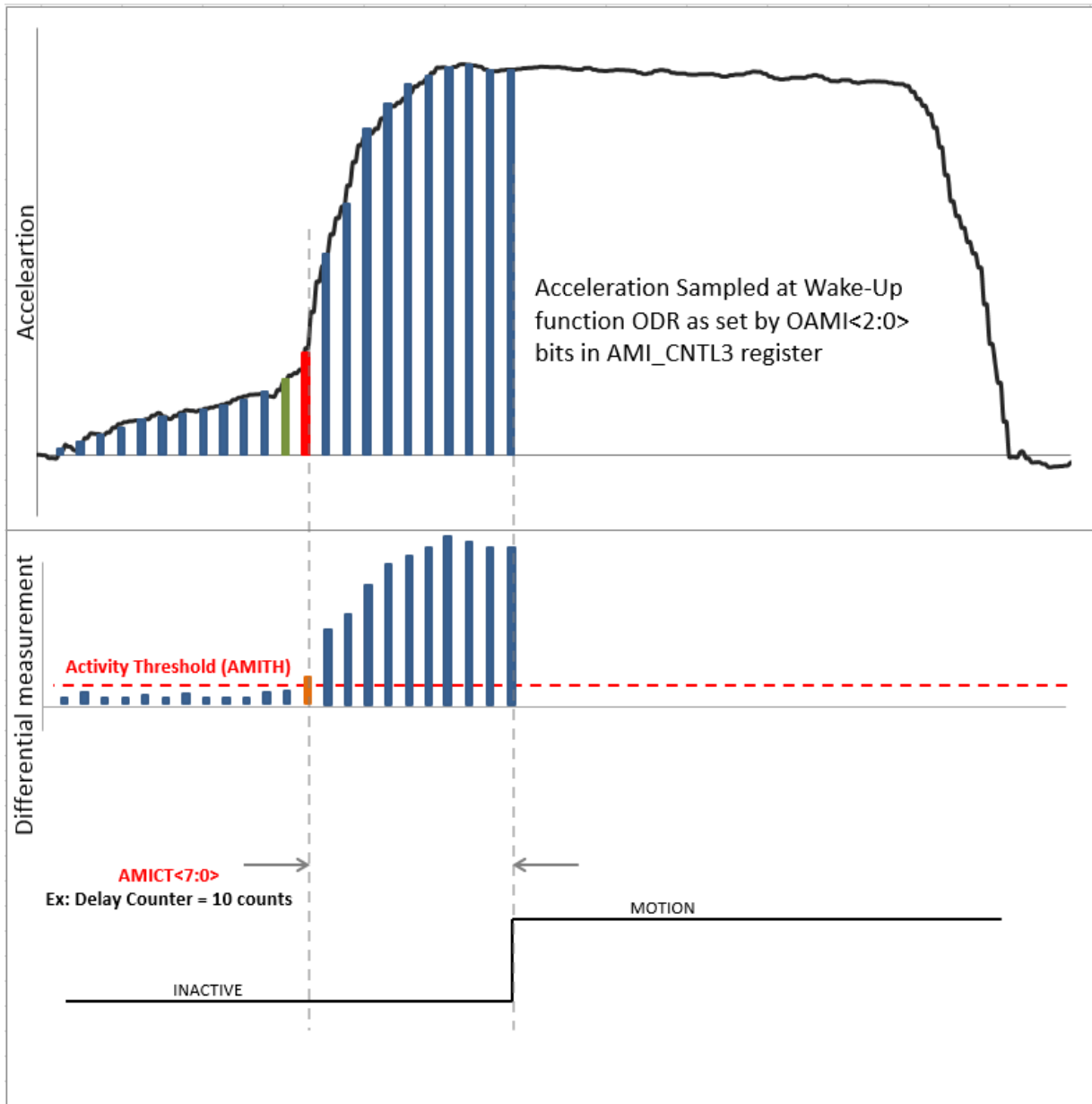

Figure 8: Latched Motion Interrupt Response

	<p align="center">± 1200uT Tri-axis Digital Magnetometer/ ± 2g/4g/8g/16g Tri-axis Digital Accelerometer Specifications</p>	<p>PART NUMBER: KMX62-1031 Rev. 4.0 20-Dec-2017</p>
---	---	--

Magnetometer Motion Interrupt Feature

The Magnetometer Motion Interrupt feature of the KMX62 reports qualified changes in the high-pass filtered magnetometer output based on the Magnetometer Motion Interrupt Threshold (MMITH). If the high-pass filtered magnetometer output on any axis is greater than the user-defined Magnetometer Motion Interrupt Threshold (MMITH), the device has transitioned from an inactive state to an active state. Equation 3 shows how to calculate the MMITH register value for a desired wake-up threshold.

$$\text{MMITH (counts)} = \text{Wake-Up Threshold } (\mu\text{T}) \times 0.107 \text{ (counts}/\mu\text{T)}$$

Equation 3: Magnetometer Wake-Up Threshold

An 8-bit raw unsigned value represents a counter that permits the user to qualify each active/inactive state change. Note that Magnetometer Motion Interrupt Counter (MMICT) count value qualifies 1 (one) user-defined Wake-up Function ODR period as set by OMMI<2:0> bits in MMI_CNTL3 register. Equation 4 shows how to calculate the MMICT value for a desired wake-up delay time.

$$\text{MMICT (counts)} = \text{Wake-Up Delay Time (sec)} \times \text{Wake-up Function ODR (Hz)}$$

Equation 4: Magnetometer Wake-Up Delay Time

The latched Magnetometer Motion Interrupt response algorithm works as following: while the part is in inactive state, the algorithm evaluates differential measurement between each new acceleration data point with the preceding one and evaluates it against the Activity Threshold (MMITH). When the differential measurement is greater than MMITH, the Magnetometer Motion Interrupt Counter (MMICT) starts the count. Differential measurements are now calculated based on the difference between the current acceleration and the acceleration when the counter started. The part will report that motion has occurred at the end of the count assuming each differential measurement has remained above the threshold. If at any moment during the count the differential measurement falls below the threshold, the counter will stop the count and the part will remain in inactive state.

	<p align="center">± 1200uT Tri-axis Digital Magnetometer/ ± 2g/4g/8g/16g Tri-axis Digital Accelerometer Specifications</p>	<p>PART NUMBER: KMX62-1031 Rev. 4.0 20-Dec-2017</p>
---	---	--

Free fall Detect

The KMX62 features a Free fall interrupt that sends a flag through the GPIO1 or the GPIO2 output pins when the accelerometer senses a Free fall event. The interrupt event is also reflected on the INT (bit 7) and FFI (bit 2) of the INS1 registers. A Free fall event is evident when all three accelerometer axes simultaneously fall below a certain acceleration threshold for a set amount of time. The KMX62 gives the user the option to define the acceleration threshold value through the FFI_CNTL1 8-bit register where 256 counts cover the g range of the accelerometer. This value is compared to the top 8 bits of the accelerometer 8g output value (independent of the actual g-range setting of the device). Equation 5 shows how to calculate the FFITH register value for a desired Free fall threshold. The threshold of 0.5g is a good starting point.

$$\text{FFITH (counts)} = \text{Free fall Threshold (g)} \times 16 \text{ (counts/g)}$$

Equation 5: Free fall Threshold

Through the Free Fall Counter (FFICT), the user can set the amount of time all three accelerometer axes must simultaneously remain below the FFITH acceleration threshold before the Free fall interrupt flag is sent through the GPIO1 or the GPIO2 output pins. This delay/debounce time is defined by the available 0 to 255 counts, which represent accelerometer samples taken at the Free fall ODR defined by OFFI<2:0> bits in the FFI_CNTL3 register. Every count is calculated as 1/ODR delay period. Equation 6 shows how to calculate the FFC register value for a desired Free fall delay. The delay of 0.32 sec is a good starting point.

$$\text{FFICT (counts)} = \text{Free fall delay (sec)} \times \text{Free fall ODR (Hz)}$$

Equation 6: Free fall Threshold

When the Free fall interrupt is enabled the part must not be in a physical state that would trigger the Free fall interrupt or the delay will not be correct for the present Free fall.



**± 1200uT Tri-axis Digital Magnetometer/
± 2g/4g/8g/16g Tri-axis Digital
Accelerometer Specifications**

PART NUMBER:

**KMX62-1031
Rev. 4.0
20-Dec-2017**

Typical Freefall Interrupt Example (nonLatching)

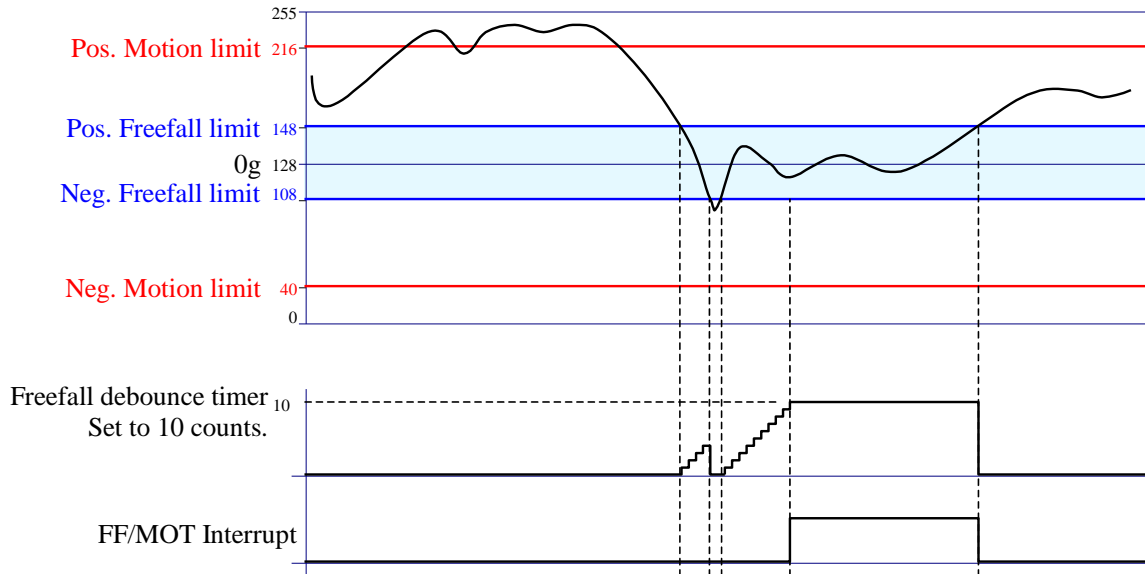

Figure 9: Typical Free Fall Interrupt Example (FFI_CNTL3 FFIUL = 1)

Typical Freefall Interrupt Example (Latching)

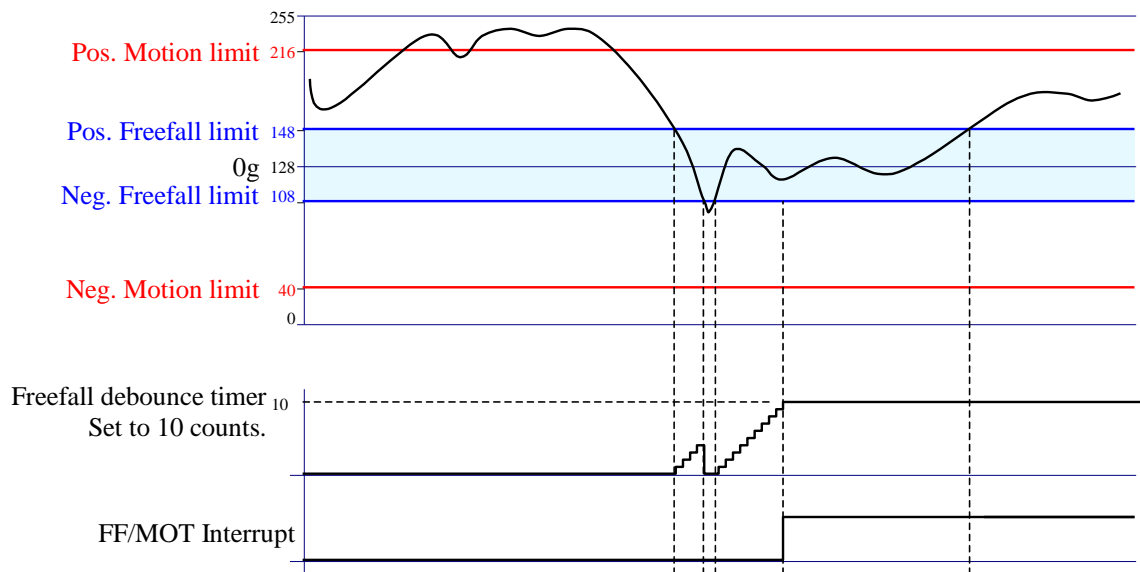

Figure 10: Typical Free Fall Interrupt Example (FFI_CNTL3 FFIUL = 0)

	<p align="center">± 1200uT Tri-axis Digital Magnetometer/ ± 2g/4g/8g/16g Tri-axis Digital Accelerometer Specifications</p>	<p>PART NUMBER: KMX62-1031 Rev. 4.0 20-Dec-2017</p>
---	---	---

Sample Buffer Feature Description

The sample buffer feature of the KMX62 accumulates and outputs data based on how it is configured. There are 4 buffer modes available. Data is collected at the highest ODR specified by OSA[3:0] and OSM[3:0] in the ODCNTL (Output Data Control) Register. Each buffer mode accumulates data, reports data, and interacts with status indicators in a slightly different way.

FIFO Mode

Data Accumulation

Sample collection stops when the buffer is full.

Data Reporting

Data is reported with the oldest byte of the oldest sample first.

Status Indicators

A watermark interrupt occurs when the number of samples in the buffer reaches the Sample Threshold. The watermark interrupt stays active until the buffer contains less than this number of samples. This can be accomplished through clearing the buffer or reading greater than SMPX.

$$\text{SMPX} = \text{SMP_LEV}[8:0] - \text{SMP_TH}[8:0]$$

Equation 7: Samples Above Sample Threshold

Stream Mode

Data Accumulation

Sample collection continues when the buffer is full; older data is discarded to make room for newer data.

Data Reporting

Data is reported with the oldest sample first (uses FIFO read pointer).

Status Indicators

A watermark interrupt occurs when the number of samples in the buffer reaches the Sample Threshold. The watermark interrupt stays active until the buffer contains less than this number of samples. This can be accomplished through clearing the buffer or explicitly reading greater than SMPX samples (calculated with Equation 7).

	<p align="center">± 1200uT Tri-axis Digital Magnetometer/ ± 2g/4g/8g/16g Tri-axis Digital Accelerometer Specifications</p>	<p>PART NUMBER: KMX62-1031 Rev. 4.0 20-Dec-2017</p>
---	---	--

Trigger Mode

Data Accumulation

When a physical interrupt is caused by one of the digital engines or when a logic HIGH signal occurs on the TRIG pin, the trigger event is asserted and SMP_TH[8:0] samples prior to the event are retained. Sample collection continues until the buffer is full.

Data Reporting

Data is reported with the oldest sample first (uses FIFO read pointer).

Status Indicators

When a physical interrupt occurs and there are at least SMP_TH[8:0] samples in the buffer, BUF_TRIG in BUF_STATUS_2 is asserted.

FILO Mode

Data Accumulation

Sample collection continues when the buffer is full; older data is discarded to make room for newer data.

Data Reporting

Data is reported with the newest byte of the newest sample first.

Status Indicators

A watermark interrupt occurs when the number of samples in the buffer reaches the Sample Threshold. The watermark interrupt stays active until the buffer contains less than this number of samples. This can be accomplished through clearing the buffer or explicitly reading greater than SMPX samples (calculated with Equation 7).

Buffer Operation

The following diagrams illustrate the operation of the buffer conceptually. Actual physical implementation has been abstracted to offer a simplified explanation of how the different buffer modes operate. Regardless of the selected mode, the buffer fills sequentially, two-byte at a time and one set count number of bytes at the highest ODR. Figure 11 shows one 14-byte data sample with all devices (accelerometer, temp sensor and magnetometer) enabled. Note the location of the FILO read pointer versus that of the FIFO read pointer. Figure 12 shows one 12-byte data sample with accelerometer and magnetometer enabled and temperature sensor disabled. Figure 12 - Figure 21 represent a 10-sample version of the buffer (for simplicity), with Sample Threshold set to 8.

Note: When a write to BUF_CLEAR register is made, the buffer read pointer is moved to the location of the buffer write pointer.

	<p align="center">± 1200uT Tri-axis Digital Magnetometer/ ± 2g/4g/8g/16g Tri-axis Digital Accelerometer Specifications</p>	<p>PART NUMBER: KMX62-1031 Rev. 4.0 20-Dec-2017</p>
---	---	---

Note: If the buffer control states that a sensor's data should be buffered, but that sensor is not enabled, then all buffer entries for that sensor will be that sensor's last ADC conversion prior to it being disabled.

Index	Byte	
0	ACCEL X_L	<---- FIFO read pointer <---- FILO read pointer
1	ACCEL X_H	
2	ACCEL Y_L	
3	ACCEL Y_H	
4	ACCEL Z_L	
5	ACCEL Z_H	
6	MAG X_L	
7	MAG X_H	
8	MAG Y_L	
9	MAG Y_H	
10	MAG Z_L	
11	MAG Z_H	
12	TEMP_L	
13	TEMP_H	
14		

buffer write pointer (Sample Level) ---->

Figure 11: One Buffer Sample with accelerometer, temperature sensor and magnetometer all enabled

Index	Byte	
0	ACCEL X_L	<---- FIFO read pointer <---- FILO read pointer
1	ACCEL X_H	
2	ACCEL Y_L	
3	ACCEL Y_H	
4	ACCEL Z_L	
5	ACCEL Z_H	
6	MAG X_L	
7	MAG X_H	
8	MAG Y_L	
9	MAG Y_H	
10	MAG Z_L	
11	MAG Z_H	
12		

buffer write pointer (Sample Level) ---->

Figure 12: One Buffer Sample with accelerometer and magnetometer enabled and temperature sensor disabled

	± 1200uT Tri-axis Digital Magnetometer/ ± 2g/4g/8g/16g Tri-axis Digital Accelerometer Specifications	PART NUMBER: KMX62-1031 Rev. 4.0 20-Dec-2017
---	---	---

Note in Figure 13 the location of the FILO read pointer versus that of the FIFO read pointer. The buffer write pointer shows where the next sample will be written to the buffer.

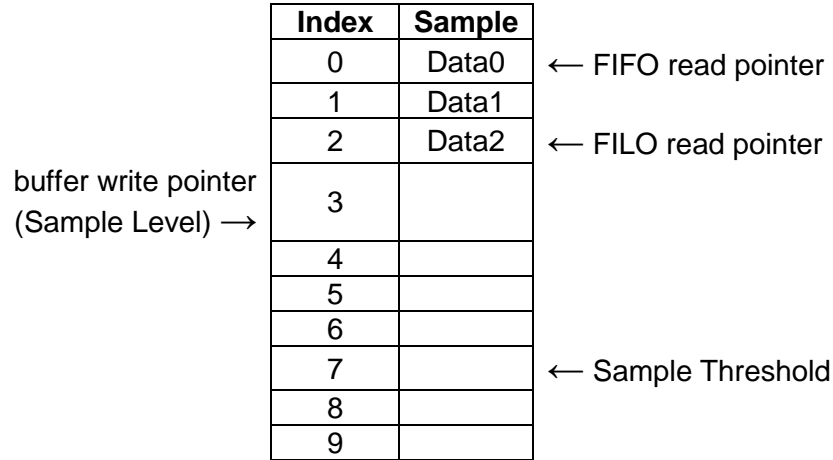

Figure 13: Buffer Filling

The buffer continues to fill sequentially until the Sample Threshold is reached. Note in Figure 14 the location of the FILO read pointer versus that of the FIFO read pointer.

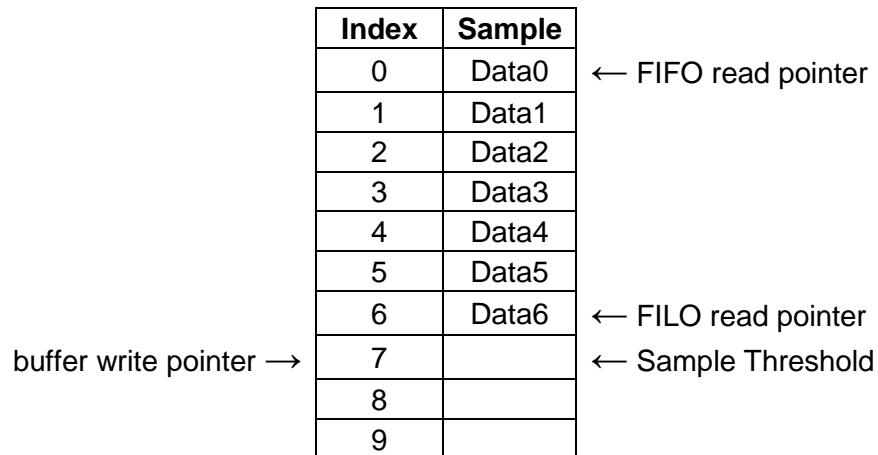

Figure 14: Buffer Approaching Sample Threshold

	<p align="center">± 1200uT Tri-axis Digital Magnetometer/ ± 2g/4g/8g/16g Tri-axis Digital Accelerometer Specifications</p>	<p>PART NUMBER: KMX62-1031 Rev. 4.0 20-Dec-2017</p>
---	---	--

In FIFO, Stream, and FILO modes, a watermark interrupt is issued when the number of samples in the buffer reaches the Sample Threshold. In trigger mode, this is the point where the oldest data in the buffer is discarded to make room for newer data.

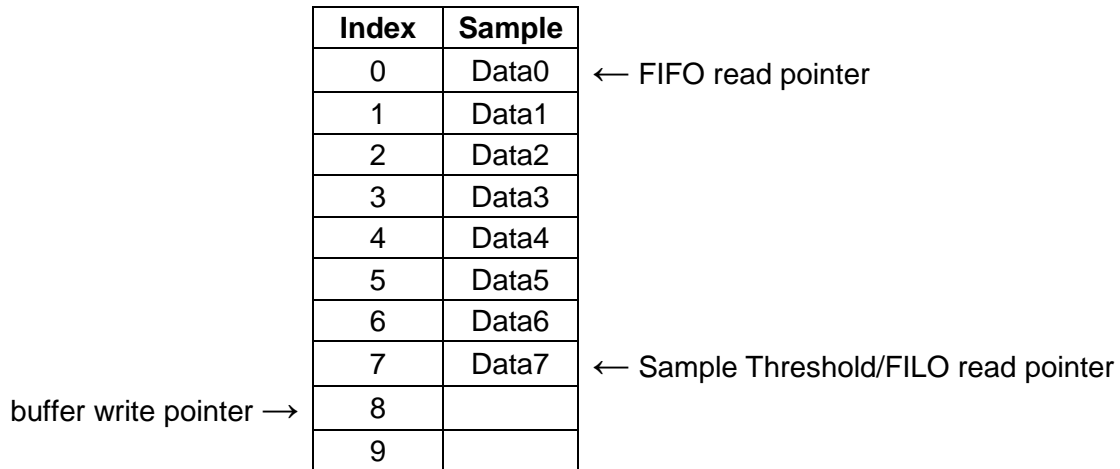

Figure 15: Buffer at Sample Threshold

In trigger mode, data is accumulated in the buffer sequentially until the Sample Threshold is reached. Once the Sample Threshold is reached, the oldest samples are discarded when new samples are collected. Note in Figure 16 how Data0 was thrown out to make room for Data8.

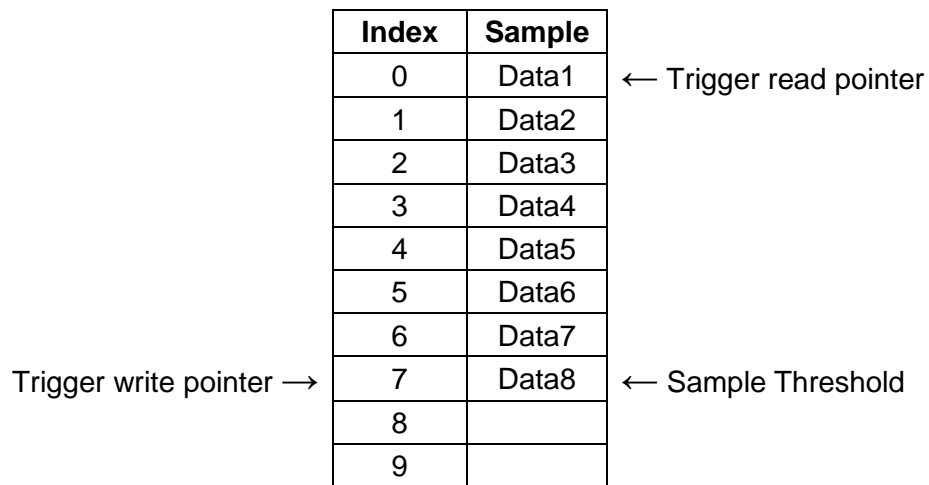

Figure 16: Additional Data Prior to Trigger Event

	<p align="center">± 1200uT Tri-axis Digital Magnetometer/ ± 2g/4g/8g/16g Tri-axis Digital Accelerometer Specifications</p>	<p>PART NUMBER: KMX62-1031 Rev. 4.0 20-Dec-2017</p>
---	---	--

After a trigger event occurs, the buffer no longer discards the oldest samples, and instead begins accumulating samples sequentially until full. The buffer then stops collecting samples, as seen in Figure 17. This results in the buffer holding SMP_TH[8:0] samples prior to the trigger event, and SMPX samples after the trigger event.

Index	Sample	
0	Data1	← Trigger read pointer
1	Data2	
2	Data3	
3	Data4	
4	Data5	
5	Data6	
6	Data7	
7	Data8	← Sample Threshold
8	Data9	
9	Data10	

Figure 17: Additional Data After Trigger Event

In FIFO, Stream, FILO, and Trigger (after a trigger event has occurred) modes, the buffer continues filling sequentially after the Sample Threshold is reached. Sample accumulation after the buffer is full depends on the selected operation mode. FIFO and Trigger modes stop accumulating samples when the buffer is full, and Stream and FILO modes begin discarding the oldest data when new samples are accumulated.

Index	Sample	
0	Data0	← FIFO read pointer
1	Data1	
2	Data2	
3	Data3	
4	Data4	
5	Data5	
6	Data6	
7	Data7	← Sample Threshold
8	Data8	
9	Data9	← FILO read pointer

Figure 18: Buffer Full



**± 1200uT Tri-axis Digital Magnetometer/
± 2g/4g/8g/16g Tri-axis Digital
Accelerometer Specifications**

PART NUMBER:

**KMX62-1031
Rev. 4.0
20-Dec-2017**

After the buffer has been filled in FILO or Stream mode, the oldest samples are discarded when new samples are collected. Note in Figure 19 how Data0 was thrown out to make room for Data10.

Index	Sample	
0	Data1	← FIFO read pointer
1	Data2	
2	Data3	
3	Data4	
4	Data5	
5	Data6	
6	Data7	
7	Data8	← Sample Threshold
8	Data9	
9	Data10	← FIFO read pointer

Figure 19: Buffer Full – Additional Sample Accumulation in Stream or FILO Mode

In FIFO, Stream, or Trigger mode, reading one sample from the buffer will remove the oldest sample and effectively shift the entire buffer contents up, as seen in Figure 20.

Index	Sample	
0	Data1	← FIFO read pointer
1	Data2	
2	Data3	
3	Data4	
4	Data5	
5	Data6	
6	Data7	
7	Data8	← Sample Threshold
8	Data9	← FIFO read pointer
9		buffer write pointer →

Figure 20: FIFO Read from Full Buffer



**± 1200uT Tri-axis Digital Magnetometer/
± 2g/4g/8g/16g Tri-axis Digital
Accelerometer Specifications**

PART NUMBER:

**KMX62-1031
Rev. 4.0
20-Dec-2017**

In FILO mode, reading one sample from the buffer will remove the newest sample and leave the older samples untouched, as seen in Figure 21.

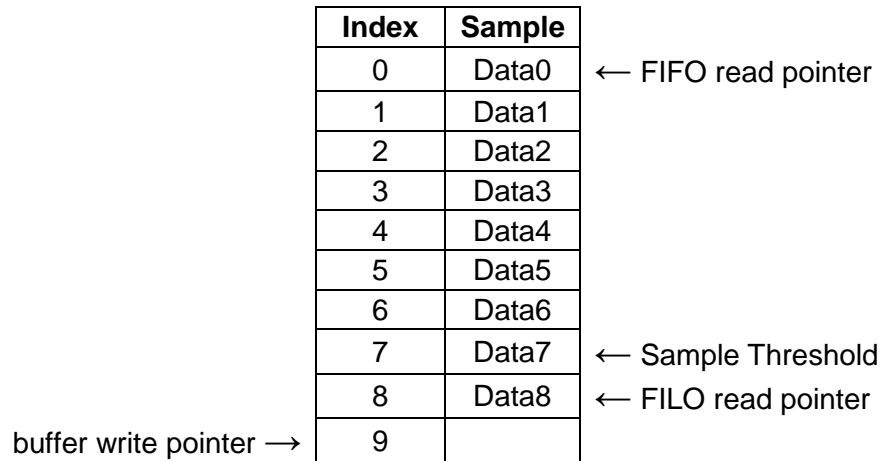

Figure 21: FILO Read from Full Buffer

	<p align="center">± 1200uT Tri-axis Digital Magnetometer/ ± 2g/4g/8g/16g Tri-axis Digital Accelerometer Specifications</p>	<p>PART NUMBER: KMX62-1031 Rev. 4.0 20-Dec-2017</p>
---	---	--

Revision History

Revision	Description	Date
1.0	Initial Release.	29-May-2015
2.0	Updated Writing/Reading Description in I2C. Updated current consumption diagrams. Updated pin description table. Added Notice. Revised environmental spec (RoHS + REACH).	20-Oct-2015
3.0	Updated Temperature (°C) Calculation 256counts/C for 16bit. Updated Trigger Buffer Description.	01-Mar-2016
4.0	Updated Filter -3dB cutoff value in RES = 00, 01. Updated maximum start up time. Updated I2C Description Sections. Added note in Pin Descriptions to indicate that pins 3, 5, and 12 (GND) are internally tied together. Updated sensitivity format to counts/g and counts/uT. Fixed temperature sensor sensitivity in 16-bit mode. Added noise density. Removed Noise plots. Removed negative self test specifications. Added Wake Up and Free Fall engine descriptions. Updated orientation and product outline drawings. Added accel orientation tables. Revised and improved register descriptions. Product Notice section is appended at the end of the document.	20-Dec-2017

"Kionix" is a registered trademark of Kionix, Inc. Products described herein are protected by patents issued or pending. No license is granted by implication or otherwise under any patent or other rights of Kionix. The information contained herein is believed to be accurate and reliable but is not guaranteed. Kionix does not assume responsibility for its use or distribution. Kionix also reserves the right to change product specifications or discontinue this product at any time without prior notice. This publication supersedes and replaces all information previously supplied.

	± 1200uT Tri-axis Digital Magnetometer/ ± 2g/4g/8g/16g Tri-axis Digital Accelerometer Specifications	PART NUMBER: KMX62-1031 Rev. 4.0 20-Dec-2017
---	---	---

Appendix

The following Notice is included to guide the use of Kionix products in its application and manufacturing processes. Kionix, Inc., is a ROHM Group company. For purposes of this Notice, the name "ROHM" would also imply Kionix, Inc.

Notice

Precaution on using ROHM Products

- Our Products are designed and manufactured for application in ordinary electronic equipments (such as AV equipment, OA equipment, telecommunication equipment, home electronic appliances, amusement equipment, etc.). If you intend to use our Products in devices requiring extremely high reliability (such as medical equipment ^(Note 1), transport equipment, traffic equipment, aircraft/spacecraft, nuclear power controllers, fuel controllers, car equipment including car accessories, safety devices, etc.) and whose malfunction or failure may cause loss of human life, bodily injury or serious damage to property ("Specific Applications"), please consult with the ROHM sales representative in advance. Unless otherwise agreed in writing by ROHM in advance, ROHM shall not be in any way responsible or liable for any damages, expenses or losses incurred by you or third parties arising from the use of any ROHM's Products for Specific Applications.

(Note1) Medical Equipment Classification of the Specific Applications

JAPAN	USA	EU	CHINA
CLASS III	CLASS III	CLASS II b	CLASS III
CLASS IV		CLASS III	

- ROHM designs and manufactures its Products subject to strict quality control system. However, semiconductor products can fail or malfunction at a certain rate. Please be sure to implement, at your own responsibilities, adequate safety measures including but not limited to fail-safe design against the physical injury, damage to any property, which a failure or malfunction of our Products may cause. The following are examples of safety measures:
 - Installation of protection circuits or other protective devices to improve system safety
 - Installation of redundant circuits to reduce the impact of single or multiple circuit failure
- Our Products are designed and manufactured for use under standard conditions and not under any special or extraordinary environments or conditions, as exemplified below. Accordingly, ROHM shall not be in any way responsible or liable for any damages, expenses or losses arising from the use of any ROHM's Products under any special or extraordinary environments or conditions. If you intend to use our Products under any special or extraordinary environments or conditions (as exemplified below), your independent verification and confirmation of product performance, reliability, etc. prior to use, must be necessary:
 - Use of our Products in any types of liquid, including water, oils, chemicals, and organic solvents
 - Use of our Products outdoors or in places where the Products are exposed to direct sunlight or dust
 - Use of our Products in places where the Products are exposed to sea wind or corrosive gases, including Cl₂, H₂S, NH₃, SO₂, and NO₂
 - Use of our Products in places where the Products are exposed to static electricity or electromagnetic waves
 - Use of our Products in proximity to heat-producing components, plastic cords, or other flammable items
 - Sealing or coating our Products with resin or other coating materials
 - Use of our Products without cleaning residue of flux (even if you use no-clean type fluxes, cleaning residue of flux is recommended); or Washing our Products by using water or water-soluble cleaning agents for cleaning residue after soldering
 - Use of the Products in places subject to dew condensation
- The Products are not subject to radiation-proof design.
- Please verify and confirm characteristics of the final or mounted products in using the Products.
- In particular, if a transient load (a large amount of load applied in a short period of time, such as pulse. is applied, confirmation of performance characteristics after on-board mounting is strongly recommended. Avoid applying power exceeding normal rated power; exceeding the power rating under steady-state loading condition may negatively affect product performance and reliability.
- De-rate Power Dissipation depending on ambient temperature. When used in sealed area, confirm that it is the use in the range that does not exceed the maximum junction temperature.
- Confirm that operation temperature is within the specified range described in the product specification.
- ROHM shall not be in any way responsible or liable for failure induced under deviant condition from what is defined in this document.

Precaution for Mounting / Circuit board design

- When a highly active halogenous (chlorine, bromine, etc.) flux is used, the residue of flux may negatively affect product performance and reliability.
- In principle, the reflow soldering method must be used on a surface-mount products, the flow soldering method must be used on a through hole mount products. If the flow soldering method is preferred on a surface-mount products, please consult with the ROHM representative in advance.

For details, please refer to ROHM Mounting specification

Precautions Regarding Application Examples and External Circuits

1. If change is made to the constant of an external circuit, please allow a sufficient margin considering variations of the characteristics of the Products and external components, including transient characteristics, as well as static characteristics.
2. You agree that application notes, reference designs, and associated data and information contained in this document are presented only as guidance for Products use. Therefore, in case you use such information, you are solely responsible for it and you must exercise your own independent verification and judgment in the use of such information contained in this document. ROHM shall not be in any way responsible or liable for any damages, expenses or losses incurred by you or third parties arising from the use of such information.

Precaution for Electrostatic

This Product is electrostatic sensitive product, which may be damaged due to electrostatic discharge. Please take proper caution in your manufacturing process and storage so that voltage exceeding the Products maximum rating will not be applied to Products. Please take special care under dry condition (e.g. Grounding of human body / equipment / solder iron, isolation from charged objects, setting of Ionizer, friction prevention and temperature / humidity control).

Precaution for Storage / Transportation

1. Product performance and soldered connections may deteriorate if the Products are stored in the places where:
 - [a] the Products are exposed to sea winds or corrosive gases, including Cl₂, H₂S, NH₃, SO₂, and NO₂
 - [b] the temperature or humidity exceeds those recommended by ROHM
 - [c] the Products are exposed to direct sunshine or condensation
 - [d] the Products are exposed to high Electrostatic
2. Even under ROHM recommended storage condition, solderability of products out of recommended storage time period may be degraded. It is strongly recommended to confirm solderability before using Products of which storage time is exceeding the recommended storage time period.
3. Store / transport cartons in the correct direction, which is indicated on a carton with a symbol. Otherwise bent leads may occur due to excessive stress applied when dropping of a carton.
4. Use Products within the specified time after opening a humidity barrier bag. Baking is required before using Products of which storage time is exceeding the recommended storage time period.

Precaution for Product Label

A two-dimensional barcode printed on ROHM Products label is for ROHM's internal use only.

Precaution for Disposition

When disposing Products please dispose them properly using an authorized industry waste company.

Precaution for Foreign Exchange and Foreign Trade act

Since concerned goods might be fallen under listed items of export control prescribed by Foreign exchange and Foreign trade act, please consult with ROHM in case of export.

Precaution Regarding Intellectual Property Rights

1. All information and data including but not limited to application example contained in this document is for reference only. ROHM does not warrant that foregoing information or data will not infringe any intellectual property rights or any other rights of any third party regarding such information or data.
2. ROHM shall not have any obligations where the claims, actions or demands arising from the combination of the Products with other articles such as components, circuits, systems or external equipment (including software).
3. No license, expressly or implied, is granted hereby under any intellectual property rights or other rights of ROHM or any third parties with respect to the Products or the information contained in this document. Provided, however, that ROHM will not assert its intellectual property rights or other rights against you or your customers to the extent necessary to manufacture or sell products containing the Products, subject to the terms and conditions herein.

Other Precaution

1. This document may not be reprinted or reproduced, in whole or in part, without prior written consent of ROHM.
2. The Products may not be disassembled, converted, modified, reproduced or otherwise changed without prior written consent of ROHM.
3. In no event shall you use in any way whatsoever the Products and the related technical information contained in the Products or this document for any military purposes, including but not limited to, the development of mass-destruction weapons.
4. The proper names of companies or products described in this document are trademarks or registered trademarks of ROHM, its affiliated companies or third parties.