

CLEANING

The exterior of the probe only should be cleaned with a soft cloth moistened with either water or isopropyl alcohol.

USING AND MAINTENANCE

The probe user should note that the protection provided by the equipment may be impaired, if the equipment is used in a manner not specified by the manufacturer.

To guarantee accurate performance characteristics, mechanical shocks should be avoided, as well as damage to the cable through excessive bending. Handle with care, especially when the extra thin spring-tip is fitted. All maintenance should be referred to qualified personnel.

SALES & SERVICE LECROY

Corporate Headquarters

U.S.A.: Chestnut Ridge
Phone (1) 914 578 6020
Fax (1) 914 578 5985

European Headquarters

Germany: Heidelberg
Phone (49) 6221 827 00
Fax (49) 6221 834 655

SAFETY INFORMATION

The probe is designed to be safe under the following conditions:

- Indoor use
- Altitude to 2000 m
- Temperature range from 0 °C to 50 °C
- Maximum relative humidity 80 % for temperatures up to 31 °C, decreasing linearly to 40 % relative humidity at 50 °C

WARNING

Do not disassemble or disconnect probes while they are connected to a voltage source. Use only grounded oscilloscopes.



Attention: Refer to this manual before using the probe.



Danger. High Voltage.

HIGH VOLTAGE

PPE 1.2 kV

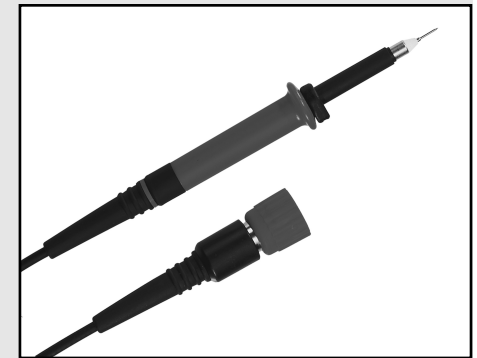

GENERAL CHARACTERISTICS

- Operating temperature:** 0 °C to 50 °C
- Cable length:** 2 m
- Weight of probe + accessories:** 70 gr
- Coupling:** 1 MΩ DC/AC
- Warranty:** One year
- Overvoltage category:** CAT I
- Pollution degree:** 1

LeCroy

ELECTRICAL CHARACTERISTICS

- System attenuation:** 10:1 / 100:1
 - System input resistance:** 50 MΩ
 - Input capacitance:** < 6 pF
 - Compensation range:** 10 pF to 50 pF
 - System BW (-3 dB):** 200 / 300 MHz typical
 - Max. non-destructive input voltage:** 1.2 kV
- See voltage derating curve

LF PROBE ADJUSTMENT (100:1)

Connect the probe to a 1 kHz square wave signal. Adjust compensation trimmer in the BNC-box for optimum square wave response.

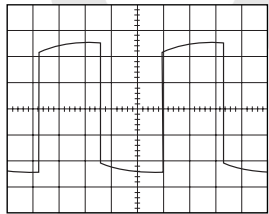

Undershoot

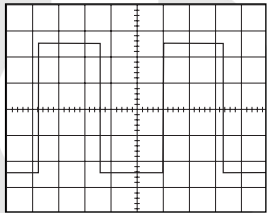

Correct

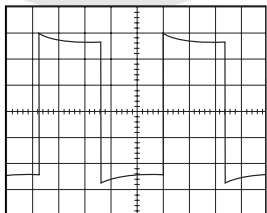

Overshoot

HF PROBE ADJUSTMENT

The probe can be adjusted for high frequency if necessary. Remove boot and isolation from BNC-box. Connect the probe to 1 MHz square wave signal. Turn the PCB in the BNC-box by 180° and adjust this trimmer for optimum square wave response. Then replace all parts again in their previous position.

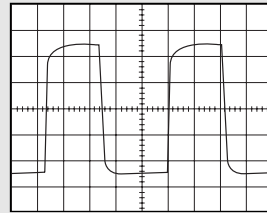

Undershoot

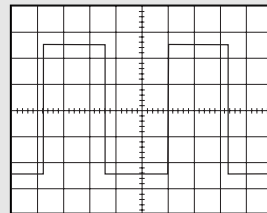

Correct

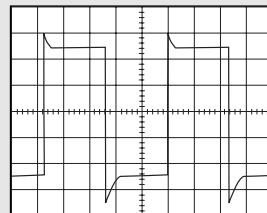

Overshoot

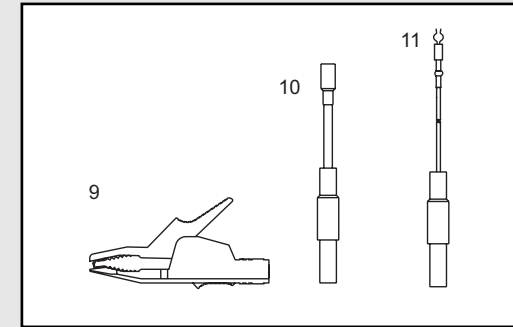
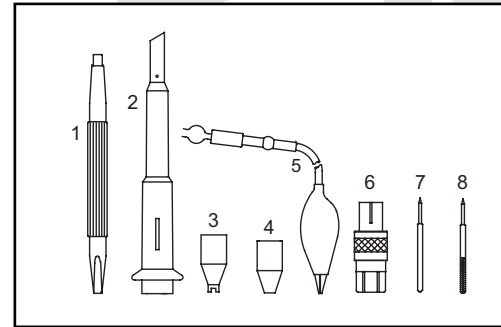

STANDARD ACCESSORIES SUPPLIED WITH THE PROBE

Accessories

Accessories	Quantities
1. Trimming tool	1
2. Sprung hook	1
3. IC Insulating tip (red)	1
4. Insulating tip (red)	1
5. Ground lead (22 cm)	1
6. BNC Adapter	1
7. Straight tip (0.8 mm)	1
8. Spring contact tip (0.8 mm)	1
9. Crocodile clip	1
10. Flexible 4 mm security adapter	1
11. Security ground lead	1

The following accessories are rated up to:

Sprung hook	1000 V
BNC Adapter	100 V
Crocodile clip	1000 V
Flexible 4 mm security adapter	1000 V

OPTIONAL PROBE KIT PK103

Same as standard accessories supplied with probe, except for:
 Straight tip (5 pieces)
 Spring contact tip (5 pieces)