

AS39513

NFC Sensor Tag and Data Logger IC

General Description

The AS39513 is a semi-passive tag chip optimized for battery-powered smart labels with sensor functionality. The chip is ideal for applications using thin and flexible batteries but it also supports fully passive operation without a battery using the RF field from an RFID reader as a power source.

The RFID interface is fully ISO 15693 and NFC-V (T5T) compliant. External power can be supplied from a single-cell battery (typically 1.5 V) or a dual-cell battery (typically 3 V).

The chip has a fully integrated temperature sensor with a programmable temperature range (default -20°C to 55°C). The external sensor interface (S_{EXT}) is an analog input and allows the connection of an external sensor.

A real-time clock can be used to generate logging times and track the device lifetime. An SPI-like interface is available for chip initialization or communication with a microcontroller. The chip has the capability to energy harvesting from reader field up to 3mA.

Configuration and logging data is stored on a configurable 9-kbit EEPROM.

Ordering Information and Content Guide appear at end of datasheet.

Key Benefits & Features

The benefits and features of this device are listed below:

Figure 1:
Added Value of Using AS39513

Benefits	Features
<ul style="list-style-type: none"> Versatile data logging with selectable option 	<ul style="list-style-type: none"> Programmable logging modes
<ul style="list-style-type: none"> Logging storage capacity up to 1020 events (8-bit logging mode) with time stamp 	<ul style="list-style-type: none"> On-chip 9-kbit EEPROM Real-time clock (RTC)
<ul style="list-style-type: none"> Supports data logging from various sensors 	<ul style="list-style-type: none"> On-chip temperature sensor Analog input for external resistive sensor
<ul style="list-style-type: none"> On-chip temperature sensor 	<ul style="list-style-type: none"> Default range: -20°C to 55°C (±0.5°C over -20°C to 10°C, gold bumped die) Temperature range is programmable
<ul style="list-style-type: none"> Flexible supply options ⁽¹⁾ 	<ul style="list-style-type: none"> Fully passive mode: no battery Semi-passive (BAP) mode: 1.5V or 3V battery
<ul style="list-style-type: none"> Provides supply for external circuitry 	<ul style="list-style-type: none"> Energy harvesting from reader field up to 3mA

Benefits	Features
<ul style="list-style-type: none"> Autonomous data logging with long battery life of ~1 year (with 30mAh printed battery) 	<ul style="list-style-type: none"> Standby current (RTC enabled): 2.14μA_{TYP} (@ 3.0V) Operating current (logging, 16ms): 166μA_{TYP} (@ 3.0V)
<ul style="list-style-type: none"> Works with NFC-enabled phones and HF readers 	<ul style="list-style-type: none"> ISO 15693/NFC-V (T5T) compliant Cool-Log™ commands for logging functions
<ul style="list-style-type: none"> Precludes manipulation and unauthorized usage of data 	<ul style="list-style-type: none"> EEPROM access from reader perpetual protected by password
<ul style="list-style-type: none"> Flexible range of packages for inlay and PCB surface mount assembly 	<ul style="list-style-type: none"> Gold bumped die 2403μm x 2313μm Thin WL-CSP 5x5 bumps @ 0.4mm pitch 2403μm x 2313μm, 316μm typ thick

Note(s):

- After battery is exhausted, the chip will continue working in passive mode (no RTC).

Applications

The AS39513 applications include:

- Cold Chain: Monitoring and tracking of temperature-sensitive products
- Temperature monitoring of medical products
- Pharmaceutical logistics
- Monitoring of fragile goods transportation

Block Diagram

The functional blocks of this device are shown below:

Figure 2:
Functional Blocks of AS39513

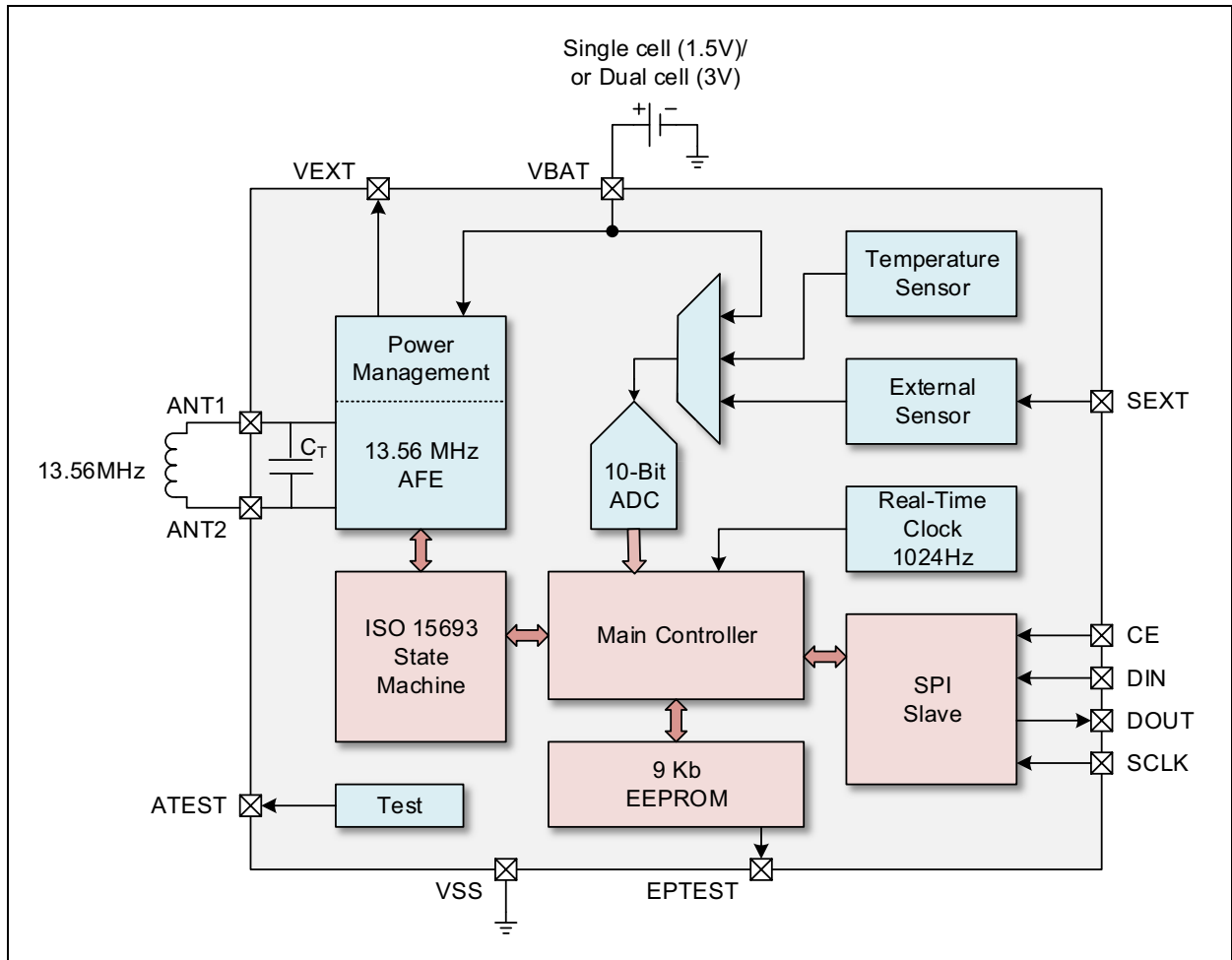

Pin and Pad Layout

The AS39513 can be shipped as bare die with gold bumps or as thin WL-CSP.

When packaged as a bare die, the pad arrangement is as depicted below (measures are reported in μm).

Figure 3:
Bare Die with Gold Bumps Pinout

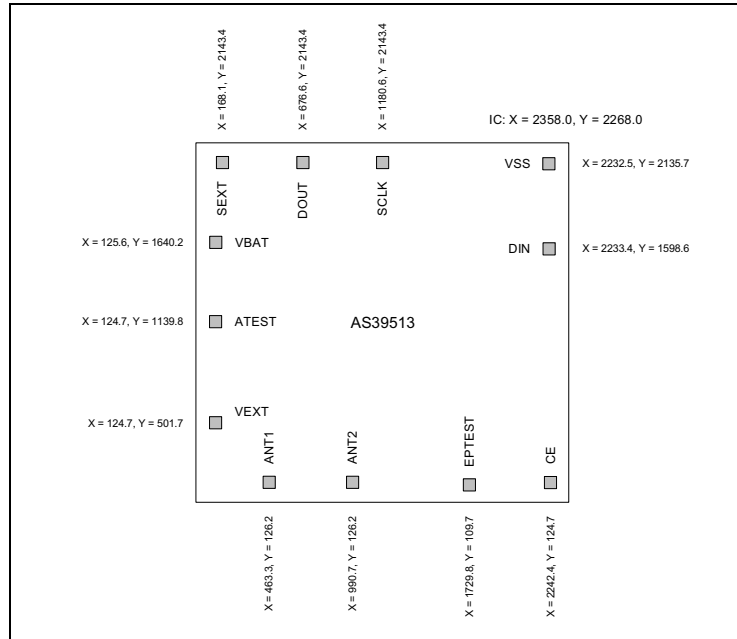

Note(s):

1. Bondpad spacing is $\geq 400\mu\text{m}$

Figure 4:
Thin WL-CSP

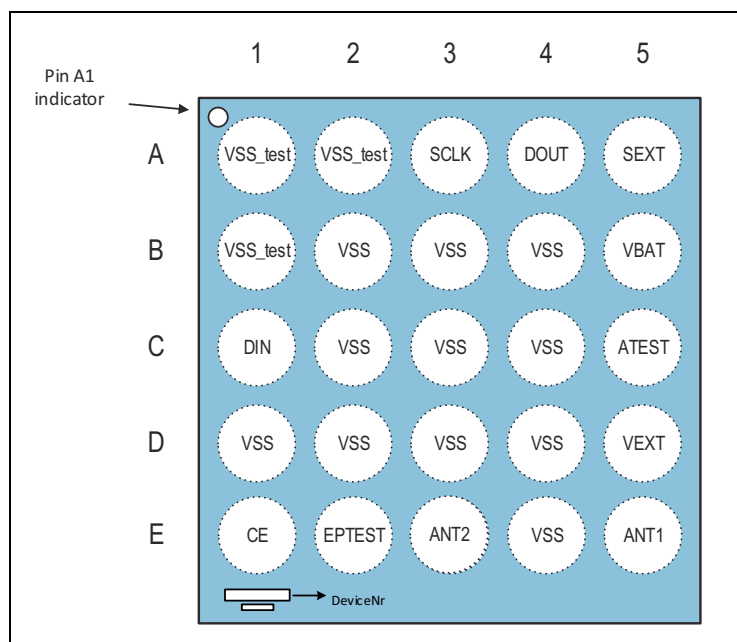

Pin Description

Figure 5:
Pin Description of AS39513 in WL-CSP

Pin	Pin Name	Pin Type	Description
A1	VSS_test	S	Negative supply and ground.
A2	VSS_test	S	Negative supply and ground.
A3	SCLK	I	SPI CLK input
A4	DOUT	O	Digital data output.
A5	SEXT	I	Analog input for external sensor.
B1	VSS_test	S	Negative supply and ground.
B2	VSS	S	Negative supply and ground.
B3	VSS	S	Negative supply and ground.
B4	VSS	S	Negative supply and ground.
B5	VBAT	S	Battery input.
C1	DIN	I	Digital data input.
C2	VSS	S	Negative supply and ground.
C3	VSS	S	Negative supply and ground.
C4	VSS	S	Negative supply and ground.
C5	ATEST	O	Analog test output.

Pin	Pin Name	Pin Type	Description
D1	VSS	S	Negative supply and ground.
D2	VSS	S	Negative supply and ground.
D3	VSS	S	Negative supply and ground.
D4	VSS	S	Negative supply and ground.
D5	VEXT	O	Power output for external circuit, generated by RF field.
E1	CE	I	SPI enable input. Note this is active high.
E2	EPTEST	O	Test pin for EEPROM. Do not connect.
E3	ANT2	I	RF input from antenna.
E4	VSS	S	Negative supply and ground.
E5	ANT1	I	RF input from antenna.

The abbreviations used in [Figure 5](#) are given below:

S = Supply

X = Not Connected

O = Output

I = Input

Absolute Maximum Ratings

Stresses beyond those listed under [Absolute Maximum Ratings](#) may cause permanent damage to the device. These are stress ratings only. Functional operation of the device at these or any other conditions beyond those indicated under [Operating Conditions](#) is not implied. Exposure to absolute maximum rating conditions for extended periods may affect device reliability.

Figure 6:
Absolute Maximum Ratings of AS39513

Symbol	Parameter	Min	Max	Unit	Comments
Electrical Parameters					
V_{BAT}/V_{GND}	Supply Voltage to Ground	-0.3	3.7	V	
V_{IN}	Input Pin Voltage to Ground except ANT1, ANT2 and SEXT	-0.3	3.3	V	
	Input Pin Voltage to Ground at ANT1 and ANT2	-0.5	6.5	V	
	Input Pin SEXT Voltage to Ground	-0.3	1.8	V	
I_{IN}	Peak Current Induced on Pin ANT1 and ANT2		30	mA	
I_{SCR}	Input Current (latch-up immunity)	± 100		mA	JEDEC JESD78D Nov 2011 Class 1
Electrostatic Discharge					
ESD_{HBM}	Electrostatic Discharge HBM	± 2		kV	JEDEC JESD22-A114F
ESD_{CDM}	ESD - Charged Device Models	± 500		V	
Temperature Ranges and Storage Conditions					
T_{JUNC}	Operating Junction Temperature	-20	65	°C	
T_{STRG}	Storage Temperature Range	-55	150	°C	
T_{BODY}	Package Body Temperature		260	°C	IPC/JEDEC J-STD-020 ⁽¹⁾
RH_{NC}	Relative Humidity (non-condensing)	5	85	%	

Symbol	Parameter	Min	Max	Unit	Comments
MSL	Moisture Sensitivity Level for thin WL-CSP	1			Represents an unlimited floor life time
t_{STRG_DOF}	Storage Time for DOF/Die or Wafers on Foil		3	months	Refers to indicated date of packing
T_{STRG_DOF}	Storage Temperature for DOF/Die or Wafers on Foil	17	28	°C	
RH_{OPEN_DOF}	Relative Humidity for DOF/Die or Wafers on Foil in Open Package		15	%	Opened package
RH_{UNOPEN_DOF}	Relative Humidity for DOF/Die or Wafers on Foil in Sealed Package	40	60	%	Sealed bag

Note(s):

- The reflow peak soldering temperature (body temperature) is specified according IPC/JEDEC J-STD-020 "Moisture/Reflow Sensitivity Classification for Non-hermetic Solid State Surface Mount Devices".

Electrical Characteristics

All limits are guaranteed. The parameters with min and max values are guaranteed with production tests or SQC (Statistical Quality Control) methods.

Figure 7:
Electrical Characteristics of AS39513

Symbol	Parameter	Min	Typ	Max	Unit	Conditions
V_{BAT3V}	3V Battery Supply Voltage	2.2		3.3	V	See note (3)
$V_{BAT1.5V}$	1.5V Battery Supply Voltage	1.35		1.8	V	See note (3)
V_{BAT_SU}	Minimum Start-Up Input Voltage		0.7		V	T= 6°C Battery assisted mode
V_{ANT}	Power On Voltage	2.5			V _P	
I_{BAT-SD}	Shutdown Current into V_{BAT}		0.5		μA	$V_{BAT} = 3.6V$; 25°C
I_{EXT}	Maximum Current from V_{EXT} Output		3		mA	In electromagnetic field
V_{EXT}	V_{EXT} Limiter Voltage		3.85		V	In electromagnetic field
R_{VEXT}	V_{EXT} Output Resistance		750		Ω	V_{EXT} internally connected to rectifier output for supply of external circuits
C_{TG}	On Chip Capacitance		35		pF	Between ANT1 and ANT2 for die with gold bump
f_{SCLK}	SCLK Serial Data Clock			100	kHz	
f_C	Carrier Frequency		13.56		MHz	
E_{WCYC}	EEPROM Erase/Write Cycles	10000			Cycles	
t_{DR}	EEPROM Data Retention Time	10			Years	T _{JUNC} = 25°C
$t_{E/W}$	EEPROM Erase/Write Speed (four-byte block)	6		10	ms	
T_{ACCGB}	Temperature Sensor Accuracy, Gold Bumped Die (logging mode only) ⁽⁴⁾	-0.5		0.5	°C	-20°C to 10°C

Symbol	Parameter	Min	Typ	Max	Unit	Conditions
$H_{\min 3Vbat}$	Sensitivity 3V battery assisted mode		150		mA/m	Class ID-1 antenna VBAT=3.0V
$H_{\min 1.5Vbat}$	Sensitivity 1.5V battery assisted mode		150		mA/m	Class ID-1 antenna VBAT=1.5V
$H_{\min pass}$	Sensitivity passive mode		280		mA/m	Class ID-1 antenna
CMOS Digital Input with 100k Ohm Pull-Down: CE, SCLK and DIN with Pull-Down Enabled⁽²⁾						
V_{IH}	High Level Input Voltage	0.7* V_{BAT}			V	
V_{IL}	Low Level Input Voltage			0.3* V_{BAT}	V	
I_{LEAK}	Input Leakage Current			1	μA	$V_{IL} = 0V$
R_D	Pull-Down Resistance		100		k Ω	
I_{PD}	Pull-Down Current	10		50	μA	$V_{IH} = V_{BAT}$
CMOS Digital Input with 30k Ohm Pull-Up Active: DIN with Pull-Up Enabled						
V_{IH}	High Level Input Voltage	0.7* V_{BAT}			V	
V_{IL}	Low Level Input Voltage			0.3* V_{BAT}	V	
I_{LEAK}	Input Leakage Current	-1		1	μA	$V_{IH} = V_{BAT}$
R_U	Pull-Up Resistance on DIN (optional see DIMD[1:0])		30		k Ω	
I_{PU}	Pull-Up Current	30		160	μA	$V_{IL} = 0V$
CMOS Digital Output DOUT						
R_{OSO}	Output Resistance Source		1.85		k Ω	
R_{OSI}	Output Resistance Sink		200		Ω	

Note(s):

1. Temperature 25°C, supply $V_{BAT}=3.3V$ from RF field unless noted otherwise
2. CMOS inputs CE and SCLK have 100k Ohm pull down resistor permanently connected. CMOS Input DIN can be configured with pull up or pull down. See DIMD[1:0].
3. Below VBAT=1.35V operation and performance of AS39513 is not guaranteed.
4. Temperature sensor accuracy measured performance on wafer with gold bumped die measured at 3.0V for 3V trimmed devices and 1.5V for 1.5V trimmed devices. Assembly method can influence the temperature sensor accuracy.

Figure 8:
Current Consumption in Different Modes

Symbol	Parameter	V _{BAT}	Typ			Unit	Conditions
			-20°C	25°C	65°C		
I _{idle}	Idle Mode Current (RTC off)	3.0V	0.85	0.84	1.05	μA	
		1.5V	0.19	0.23	0.40	μA	
I _{wait}	Wait Mode Current (RTC on)	3.0V	2.10	2.14	2.31	μA	
		1.5V	0.76	0.95	1.15	μA	
I _{active}	Active Mode Current (RTC on)	3.0V	2.11	2.14	2.32	μA	
		1.5V	0.76	0.95	1.15	μA	
I _{loggingT}	Logging Mode – Temperature Only	3.0V		166		μA	Logging time 16ms typ
		1.6V		150		μA	Logging time 27ms typ
I _{loggingAll}	Logging Mode: Temperature, Battery, Ext. Sensor with Battery Check Enabled	3.0V		170		μA	Logging time 20ms typ

Note(s):

1. The values at -20°C and 65°C are typical but not measured in final test.

Figure 9:
Operating Conditions

Symbol	Parameter	Min	Max	Unit	Comments
V _{BAT}	Battery Voltage	1.35	3.6	V	
I _{LIM}	Limiter Current		30	mA	

Detailed Description

The AS39513 is designed for use in smart semi-passive labels as well as in full passive labels. Smart semi-passive labels are defined as thin and flexible labels that contain an integrated circuit and a power source. Semi-passive smart labels, also known as battery-assisted back-scattered passive labels, enable enhanced functionality and performance over passive labels. The IC includes sensor functionality and logging of sensor data. The RFID portion of the AS39513 operates at 13.56 MHz and is fully ISO15693 and NFC-V (T5T) compliant. The sensor controller runs with an independent 1.92 MHz clock. The chip is supplied from a single-cell battery of typically 1.5V, or from a dual cell battery of typically 3V. The on-chip temperature sensor and real-time clock (RTC) accommodate temperature data logging with time stamps.

Power Management

The AS39513 is supplied from either the battery or through the power coupled from the RFID reader. The device (sensors, ADC, real-time clock and logic) is normally supplied from the battery unless there is no battery attached (passive label), or when the battery is drained. When no battery power is available, these circuits will be powered by the RFID reader. The RFID AFE is always powered by the reader.

Note 1.5V and 3V batteries are supported but the battery supply voltage range is not continuous from 1.35V to 3.3V. Please see electrical characteristics. Also it is assumed the battery will be connected when the RF field is not present. Correct operation is not guaranteed if the battery is connected in the presence of an RF field.

Energy Harvesting

AS39513 has harvesting capability. The regulated voltage output pin for energy harvesting is VEXT. If an RFID reader is present, the harvested reader power is then available externally through the VEXT pin. An internal regulator limits the voltage at VEXT 3.85V nominal. The output impedance of this voltage source is fixed and it is approximately 750Ω.

Analog Front End (AFE)

The analog front end (AFE) operates at a carrier frequency of 13.56 MHz according to the ISO 15693 and NFC-V type 5 tag standards. The incoming data is demodulated from the received ASK (Amplitude Shift Keying) signal, with either 10- 30% modulation index or 100% modulation index. Outgoing data is transmitted from the AS39513 using load modulation and employs Manchester coding with one or two sub-carrier frequencies: 423.75 kHz ($f_c/32$) or 484.28 kHz ($f_c/28$).

Processing and Digital Control

The AS39513 is fully ISO15693 compliant. The processing of the incoming data is executed by the ISO15693 CODEC block that formats the data in a frame according to the ISO specification.

Both data coding modes (1 out of 256 and 1 out of 4) are supported by the AS39513. The reader (interrogator) makes the mode selection as part of the SOF (Start of Frame). The 1-of-256 data coding mode has a data rate of 1.65 kbit/s ($f_c/8192$) meaning that the transmission of one byte takes 4.833 ms. The 1-of-4 coding has a rate of 26.48 kbit/s ($f_c/512$) with the transmission of one byte requiring 302.08 μ s.

This RFID interface can be used to access most of the EEPROM storage and to control the operating mode of the AS39513.

Slave Serial Interface (SPI-like)

The integrated serial interface (SPI-like) can be used to configure and test the chip.

The SPI-like bus can also be used for the communication between a microcontroller externally attached to the AS39513.

With the correct access password, it can also be used to access all regions of the EEPROM and the AS39513 test modes.

Please note SPI enable is active high. The SPI Read command also has 2 timing issues which need to be observed and are explained in the section SPI timing.

Real-Time Clock (RTC)

The on-chip real-time clock (RTC) is an integrating RC-type oscillator that is factory trimmed to 1.024 kHz with a typical accuracy of $\pm 3\%$ over the operating range of the device. This oscillator is used to generate logging intervals (between 1 second and 9.1 hours) and track the time since the chip was first initialized. The start time for the logging process can be programmed in UPC format by writing the related parameter in the EEPROM configuration.

Temperature Sensor

The on-chip temperature sensor is configured and calibrated to measure temperatures between -20°C to 55°C. The gold bumped die achieve an accuracy of $\pm 0.5^\circ\text{C}$ over -20°C to 10°C. The on-chip sensor can be reconfigured for a number of different temperature ranges but the sensor requires recalibration after each temperature range change.

The temperature sensor is intended to be used in logging mode. The temperature sensor accuracy is only guaranteed in this mode and not in the presence of a strong RF field from a reader. When placed in the presence of a reader, strong RF fields can cause self heating of the chip depending on the field strength, antenna and length of time in the field. The accuracy of the on-chip temperature sensor can then not be guaranteed.

External Sensor

The on-chip external sensor interface provides a means for using both resistive and voltage-based sensors. The voltage at the sensor node can be scaled and shifted in order to cover a voltage range of 0V to 1V, or a subset of that range.

The external sensor input S_{EXT} can be also used for event-triggered logging. In this condition the logging is not triggered in predefined time intervals from the internal timer, but can be triggered externally, either with a sensor, switch or a microcontroller.

The S_{EXT} has in fact a very low power sensing interface that can be used to trigger logging events when the sensor voltage crosses one of four selectable thresholds. In addition an optional drive current can be supplied to the sensor. The maximum allowable voltage on the S_{EXT} pin is 1.8V.

Analog to Digital Converter

The chip has an integrated 10-bit analog to digital converter (ADC) with selectable voltage references. It is used for voltage conversion from the temperature sensor, the external sensor, and the external battery voltage.

Data Protection

The 9-kbit EEPROM is accessed through a controller that manages the overall chip operation. Every address in the memory map is assigned to one of four types of access levels. There is write protection for three memory areas (System, Application, and Measurement) using three different 32-bit passwords. All three memory areas are open for read at all times. A fourth memory area, called the Factory area, is much more restricted and is not accessible via RF except for the lock bits and passwords. This is used for passwords, memory lock bits, and some calibration information.

For the Application, Measurement and System Access areas the access via RF remains open until the RF field is removed (the access via RF will close with the loss of RF field even if the logic is continuously powered by an external battery). Note if the chip is powered by a battery these areas will still be accessible by SPI.

The chip also supports a one-time use secure mode. When this mode is used, the RFID write capability for all Application and Measurement blocks is blocked. The measurement area can still be written through the logging operations, but the logging results cannot be overwritten through the RFID interface even if the 32-bit password is known.

System Description & Modes of Operation

Once the AS39513 has been powered either from a battery or the RFID interface, the controller logic manages the operation of the IC according to the state diagram below.

Figure 10:
State Transition Diagram

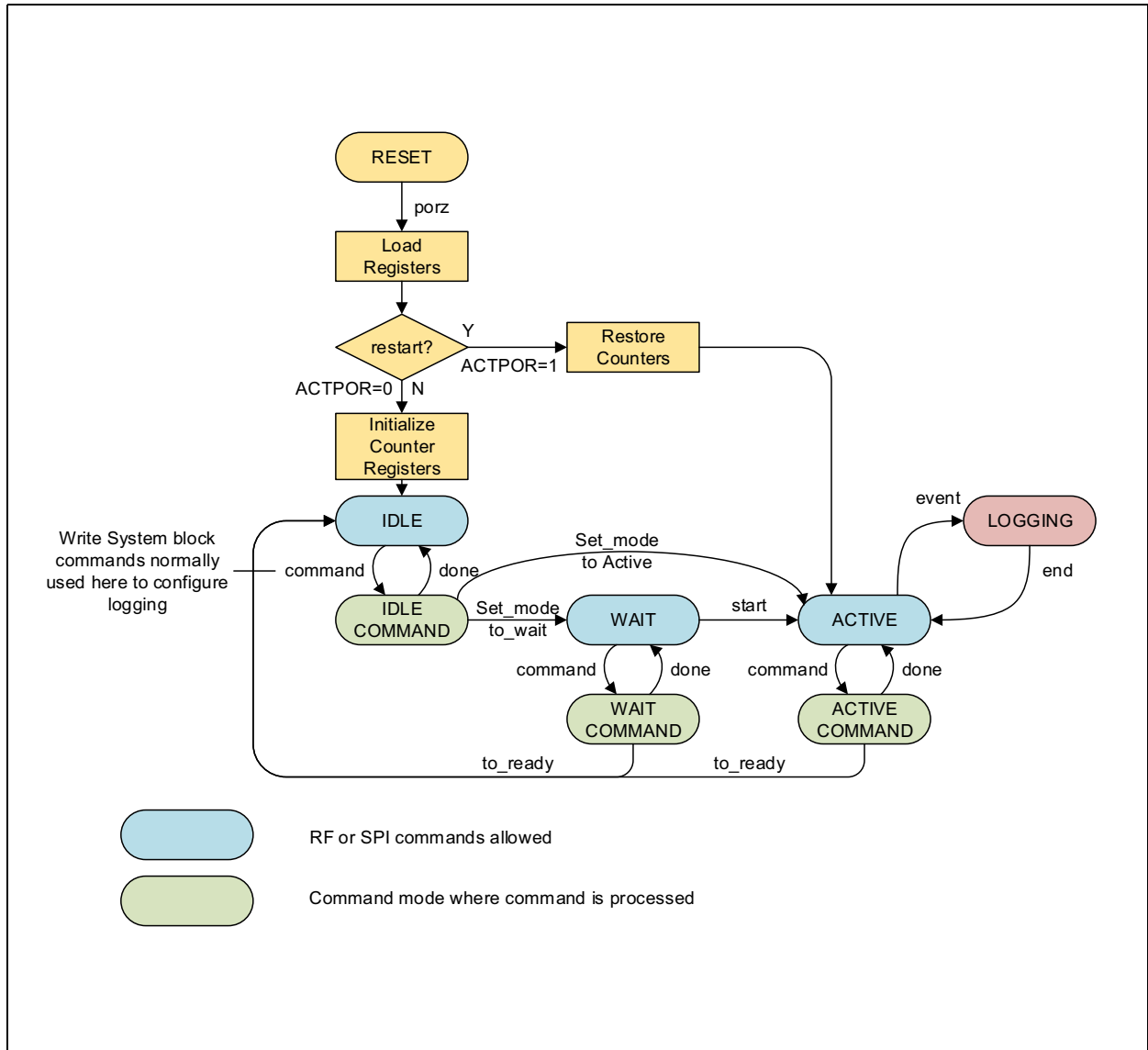

The description of each operation mode is reported in the next sections.

Initializing the Chip

A virgin chip (not initialized) can be initialized either through the SPI port or through RFID interface from a reader. Once the battery voltage is applied to the VBAT pin or the supply voltage is extracted from the RF field, the AS39513 boots up with the default factory configuration. Within about 300 μ s after power is applied, the logging controller goes to the IDLE state where it waits for configuration. Once all of the configuration information has been written to the device using write system block commands, the RFID “Set Mode” command is used to place the AS39513 either into the WAIT state or into the ACTIVE state directly. If in the WAIT state, a timer or input action can move the device into the ACTIVE state. Once in the ACTIVE state, the AS39513 will begin logging data whenever a logging event occurs.

RESET Mode

Once the chip powers up, either from the battery or the RF field, and the power is stable, the initialization process begins. At this point, the controller logic will read specific EEPROM addresses and load them into “shadow” registers.

During this phase the battery type will be determined by checking System parameter BTYPE available in the EEPROM field.

Two of the other EEPROM fields that will be read during this phase are the System parameters WAKEMD (wake up mode) and ACTIVE (true if last state was ACTIVE). If both of these fields are high, it means that the chip was reinitialized from a previous ACTIVE mode and the restart condition flag ACTPOR will be set to high.

If the restart condition is true (ACTPOR is high) then the measurement pointers and counters are reloaded from the last available state and the device returns to the ACTIVE mode.

If the restart condition is false (ACTPOR is low), the register pointers and counters are initialized assuming that no measurements have been made but the MEASCNT and MEASPTR values in EEPROM will be retained, and the device enters IDLE mode. This means that if for example the battery voltage dropped during a logging event and caused a POR, the chip would enter idle mode ie stop, but the MEASCNT and MEASPTR values would be retained in EEPROM. If the mode is subsequently changed to Active (i.e. logging is restarted), the EEPROM MEASCNT and MEASPTR are zeroed. (The bit fields ACTPOR, WAKEMD, and ACTIVE are further documented in the [Memory Map](#) section).

IDLE Mode

In the IDLE mode the device is waiting for commands either from the RFID or SPI interface. In this state the device can be first initialized after the first power up by setting the related EEPROM parameters. Initiating either interface and sending a command enables the internal “command” signal that moves the device into IDLE COMMAND mode.

In IDLE mode the data logging parameters can be configured using Write System Block commands. Once fully configured a Set mode command can be used to either commence logging or change state to the WAIT state.

WAIT Mode

In WAIT mode the device is waiting before to enter in the ACTIVE mode for a defined condition that is dependent on the System parameters (Logging Control Parameters) set in the EEPROM. WAIT mode provides in fact a mechanism to delay the start of logging after the Set Mode command is issued.

If the parameter TMSRT is set to 1, then the WAIT mode will transition to the ACTIVE mode after $\text{LOGDEL} * 512$ seconds, where LOGDEL is also part of the System Parameters.

If the parameter DIMD[1:0] is 2'b10, then the WAIT mode will transition to the ACTIVE mode when the DIN pin is pulled low.

If TMSRT is 0 and DIMD is not 2'b10, then the WAIT mode will transition without delay to the ACTIVE mode. (The bit fields TMSRT, DIMD, and LOGDEL are further documented in the [Memory Map](#) section.)

Commands from either the RFID or SPI interfaces are accepted in the WAIT mode. If a command request and a start event occur at the exact same time, the command processing has priority; the mode will transition to ACTIVE when the command is done. If a command is being processed when a start event occurs, the start event is pending until the command is completed and then the transition to ACTIVE mode occurs.

When the device transitions from the WAIT to the ACTIVE mode, the real time clock counter (RTC) is reset to 0. In this way, the baseline time of the AS39513 is the time that the device was placed in ACTIVE mode.

ACTIVE Mode

In ACTIVE mode, the device waits for a logging event to begin logging. The logging events can be generated by the real-time clock, a voltage level on the SEXT pin, or a digital signal on the DIN pin. Each type of logging event can be individually enabled by System parameters in the EEPROM. When any one of the enabled logging events occur, the mode transitions to the LOGGING mode and the data measurement and logging commences. If two logging events happen to occur in the exact same clock cycle, only one logging operation will be performed. Commands from either the RFID or SPI interfaces are accepted in the ACTIVE mode. If a command request and a logging event occur at the exact same time, the command request has priority. If a command is being processed when a logging event occurs, the logging event is pending until the command is completed and then the logging commences.

COMMAND Mode

The COMMAND modes process a command either from the RFID or SPI interface. Whichever interface issues the command first gets priority. The other interface will get a “device busy” error until the first command is completed. If both interfaces happen to request a command on the exact same clock edge (very unlikely), the RFID interface will get priority.

There are three versions of COMMAND mode, one for each of the calling modes: IDLE, WAIT, and ACTIVE. The only difference in these COMMAND modes is that when the command processing is complete, the mode will return to the mode that initiated the command.

The exception is the command that purposely generates a mode change, Set Mode. For example, if the device is in the IDLE mode and the Set Mode command is called to change to the WAIT mode, the device returns from the IDLE COMMAND mode to the WAIT mode.

LOGGING Mode

In LOGGING mode, a sequence of measurements followed by an optional sequence of storing logging values takes place. This sequence is described in the following subsections.

Battery Check

Before executing any measurement it is possible to check the status of the battery by performing the so called Battery Check. Battery check is recommended and enabled by default. It is executed if the System parameter BATCHK is set to 1, then a coarse battery check is enabled. The reason of performing this check is that the power-on-reset only ensures that the battery voltage is enough for the logic to function but it does not guarantee that the battery voltage is within the tolerances for accurate measurements.

The battery check involves the following steps. First, the battery check sensor elements are enabled. There is a brief wait for the analog circuits to settle. Using the battery type determined during RESET mode, the battery check comparator output will indicate if the battery voltage is acceptable. If it is, then the rest of the logging continues, if it is not, the logging stops, and the error flag, present in the System parameter, LOWBAT is set. Note that if a logging event was skipped because of low battery, the measurement counter is still incremented to give some indication of how many measurements were skipped. Because the battery may be too weak for a reliable write, the measurement counter will not be written to EEPROM if the battery voltage check has failed.

Figure 11:
Battery Check Threshold Voltages

Battery Type	BCKSEL [1:0]	Threshold Voltage (V)
1.5V	00	1.2
3V	00	2.2
3V	01	2.1
3V	10	2.0
3V	11	1.9

Sensor Measurements

After the battery check, the sensor measurements are made. The three possible measurement that consist of Temperature, External Sensor and Battery Voltage are independently enabled by the System parameters TSMEAS, EXMEAS, and BVMEAS part of the System EEPROM fields, and they are executed in a fixed sequence as they are reported below.

First, there is the temperature measurement. If TSMEAS is 1, the temperature circuits are enabled, and the temperature configuration values for the references and ADC are loaded. After a wait period for analog settling, an ADC measurement is taken, and the result is stored in `ts_res_ff[9:0]`.

Next is the external sensor measurement. If EXMEAS is 1, the external sensor circuitry is enabled, including the optional current drive for the external sensor. The external sensor values for the references and ADC are loaded, and a wait period ensues to allow for analog settling. After the wait period, an ADC measurement is taken, and the result is stored in `ex_ref_ff[9:0]`.

Finally, there is the battery voltage measurement. If BVMEAS is 1, the battery measurement circuits are enabled, and the battery voltage configuration values for the reference and ADC are loaded. After a wait period for analog settling, an ADC measurement is taken, and the result is stored in `bv_res_ff[9:0]`.

Limit Check Algorithm

Once all the enabled measurements are done, an optional limit check algorithm begins. The AS39513 can be set to only record logging information if certain limit conditions are met. The internal temperature sensor and external sensor each have independent limit conditions. The ADC result for each sensor measurement is compared to four thresholds to determine the limit result. The limit thresholds are each 8-bit in length and are the 8 MSB values when compared to the 10-bit ADC values. The limit results follow the tables below. If a sensor is not enabled for logging, its limit result is taken to be 3'b000.

Figure 12:
Limit Check Results for Temperature Sensor

Step	Condition	ts_lim
1	$ts_res_ff \geq \{TXHILIM, 2'b00\}$	3'b100
2	$ts_res_ff \leq \{TXLOLIM, 2'b11\}$	3'b101
3	$ts_res_ff \geq \{THILIM, 2'b00\}$	3'b110
4	$ts_res_ff \leq \{TLOLIM, 2'b11\}$	3'b111
5	Otherwise	3'b000

Figure 13:
Limit Check Results for External Sensor

Step	Condition	ex_lim
1	$ex_res_ff \geq \{EXHILIM, 2'b00\}$	3'b100
2	$ex_res_ff \leq \{EXLOLIM, 2'b11\}$	3'b101
3	$ex_res_ff \geq \{EHILIM, 2'b00\}$	3'b110
4	$ex_res_ff \leq \{ELOLIM, 2'b11\}$	3'b111
5	Otherwise	3'b000

Note that in the computation of the limit result, the conditions are checked in the order given in the tables above. It is possible that more than one condition can be met at the same time, because there is no check on the relative values of the four limit parameters for each sensor. The first condition that is true in the order given in the table is the condition that determines the limit result.

The limit check algorithm is as follows. The limit result for each sensor is computed. For each limit result that is non-zero, the limit counter that corresponds to that limit flag is incremented.¹ The over limit count flag OVLIM will be set if any of the following conditions are true: TXHICNT > 0, TXLOCNT > 0, THICNT > THIMAX, TLOCNT > TLOMAX, EXHICNT > 0, EXLOCNT > 0, EHICNT > EHIMAX, or ELOCNT > ELOMAX (These System parameters are further documented in the [Memory Map](#) section).

There are two types of limit check modes: normal and limit crossing.

If normal limit mode is selected (LOGMD = 2'b10), then logging will occur if, and only if, at least one of the two sensor's limit results is non-zero.

If limit crossing mode is selected (LOGMD = 2'b11), then logging will occur if, and only if, the limit result for either sensor is different from that sensor's previous measurement limit result. At initialization, the "previous" limit result for each sensor is assumed to be 3'b000. Therefore, the first measurement that will be logged will be the first time that at least one of the two sensor's limit results is non-zero.

If neither of the limit modes are selected (LOGMD[1] = 0), then no limits are checked, the limit counters are not changed, and the measurement results are always logged.

Measurement Results Logging

If one of the limit criteria are satisfied, or if the device is in the no-limit logging mode (LOGMD = 2'b00 or 2'b01), then the measurement results are logged.

Memory Check: Prior to writing the log values in EEPROM, the logging measurement pointer MEASPTR[11:0] is checked to insure that there will be room for the log data.

If there is no room and STRMD is 0, the data is not logged, and the error flag EEFULL is set.

1. The limit counters are simple binary counters. If a limit count exceeds 16'hFFFF (65,535), then the count will wrap around to zero.

Memory Pointer: Assuming the data can and should be logged, the logging begins at the current value of the MEASPTR[11:0], where MEASPTR[11:2] represents the EEPROM address for the first log data, and $2 * \text{MEASPTR}[1:0]$ is the bit position at which to start the log data. The data is logged in the following order, with increasing pointer addresses for each log value.

Once all the logging values are stored, and if the adjust logging information ADJUST parameter is set to 1, then the MEASPTR is rounded up to the nearest byte boundary. This wastes some memory space in return for being able to easily calculate the byte position of each log point.

Format Options: In order to minimize EEPROM usage, data is logged at 2-bit boundaries according to the format options LOGFMT: all measurement data is logged using either 8 or 10 bits.

The 8-bit format is used if both logging mode LOGMD = 2'b00 and logging format LOGFMT = 0. Otherwise, 10 bits are used.

Measurement Storing Sequence: First, if a temperature measurement was made, the result in ts_res_ff is written. Second, if an external measurement was made, the value in ex_ref_ff is written. Third, if a battery voltage measurement was made, the result in bv_res_ff is written.

Note the number of bits (8 or 10) stored for the temperature, external sensor and battery voltage measurements depends on the LOGFMT and LOGMD configuration settings.

Optional Status Signals: After the measurements are recorded, the status of two digital signals can optionally be recorded. If the optional logging data DLOG is 1, then the values of the digital signals at the DIN pin (the digital input din_i) and the external sensor interrupt SEXT (extirq_i) are recorded using the 2-bit value { din_i, extirq_i }.

Note that if DLOG is the only logging option selected, that means, there are no ADC measurements enabled, then the logging state machine will wait about 3ms (the approximate time for one ADC conversion) in order for the external voltage at the SEXT pin to settle.

Note that if the value of the extirq_i signal want to be used, then the Enable external sensor interrupt EIEN field must be set to 1 in order to enable the comparator that generates the extirq_i interrupt event.

Logging Modes: Finally, information about this measurement are written, depending on the logging mode.

If interrupt logging mode is used (LOGMD = 2'b01), then the 30-bit real-time clock counter value is logged, followed by a two-bit value that indicates the logging event trigger source (further detail will follow in the [Memory Map](#) section).

If one of the two limit logging modes is used (LOGMD = 2'b01 or LOGMD = 2'b11), the 16-bit log counter LOGCNT is written into the EEPROM.

Status Parameters: As a last step in the logging operation, the measurement count, MEASCNT, is incremented.

If update counts SKIP16 = 0 or MEASCNT[3:0] = 4'b1111, then MEASCNT, the status bits ACTIVE, EEFULL, OVWRT, ADCERR, LOWBAT, and OVLIM, and the ending measurement pointer MEASPTR are written into EEPROM.

Even if no logging occurred (because the limit conditions were not met or the EEPROM was full), the measurement count MEASCNT is still incremented and written into EEPROM (still using the SKIP16 option to only write once every 16 measurements). The measurement counter MEASCNT clips at 16'hFFFF so that it does not wraparound to 0. The measurement pointer MEASPTR is only updated if data was logged to the EEPROM; it always points to just after the end of the data that was actually written to EEPROM.

Logging Arbitration: In the condition that another enabled logging event occurs before the logging of the current event is complete, the next logging event will be queued and will commence at the completion of the current logging operation.

If an RFID or SPI command request occurs during logging, the command is ignored in order to prevent conflicts in EEPROM access.

Power Modes

The controller modes described above also control which of the sensor blocks are enabled.

If the controller is in any of the COMMAND modes, the LOGGING mode or the RESET initialization, there is a high-speed (1.92 MHz) ring oscillator that is enabled to clock the controller logic and the EEPROM.

In the LOGGING mode, there are three additional power modes. Battery check mode (bchk_md) enables all the sensor circuits needed to do the coarse battery check, which is basically everything in the sensor system except the ADC. Measure mode (meas_md) enables basically everything in the sensor system except the battery check circuit; this mode is used for temperature and external sensor measurements. Battery voltage mode (both bchk_md and meas_md enabled) is used to measure the battery voltage.

If the AS39513 is not in one of the modes requiring the ring oscillator, the ring oscillator is disabled and the lowpow signal is asserted. This signal causes the power switch in the AFE to switch to an unregulated supply for the logic, further reducing the power consumption. The only circuits that are operational in this low power mode that would draw current from the external battery are the real time oscillator (if OSCEN = 1) and the external interrupt comparator (if EIEN = 1).

Data Log Functions

The AS39513 device supports various flexible data log formats. The data log format depends on the Logging form. The data log formats are defined in Figure below. The Logging form is set with the logging mode LOGMD[1:0] System parameter stored in the [Logging Control Parameters](#) address 0x43B (bits 4-5) in the EEPROM.

Figure 14:
Supported Logging Formats

Bit 5	Bit 4	Logging Form	Description
0	0	Dense	Logging will occur for all logging events. No measurement count or real-time clock values will be logged.
0	1	Interrupt	Interrupt mode. Logging will occur for all logging events. Sensors are always logged to 10-bit accuracy. The real-time clock value and interrupt source are logged. The interrupt source is a two-bit value: 2'b01 = external sensor interrupt, and 2'b10 = DIN interrupt.
1	0	Normal limit	Enable logging if any of the limit check conditions are met. Sensors are always logged to 10-bit accuracy. If a measurement is logged, the value of the measurement counter is also logged.
1	1	Limit crossing	Enable logging only if one of the limit check conditions is different than that from the previous logging event. Sensors are always logged to 10-bit accuracy. If a measurement is logged, the value of the measurement counter is also logged.

Storage Mode

The storage mode defines what happens when the logging area in the EEPROM is full.

The storage mode is set with the storage mode STRMD System parameter, stored in the [Logging Control Parameters](#) address 0x40E (bit 6) in the EEPROM.

Figure 15:
Storage Mode

Bit	Storage Mode	Description
0	Normal	When the logging area in the EEPROM is full, the chip does not store any new sensor data to the EEPROM, additional logging values will be lost.

Logging Timer

The AS39513 device has an integrated RC oscillator that is calibrated to 1024Hz. This oscillator drives the logging timer. The logging timer resolution is 1 second. The maximum period is 9.1 hours (32'768 seconds). The logging interval is programmed by setting the LOGINT System parameter.

The measurement real time is derived from 4 parameters – the Start time (STIME), the Delay time (LOGDEL), the log interval (LOGINT), and the # of the measurement (MEASCNT). This value has to be calculated in the reader by the equation:

$$\text{Real time} = \text{STIME} + \text{LOGDEL} + \text{LOGINT} * \text{MEASCNT}$$

Delay Time

The AS39513 supports delayed start of the logging procedure. The Delay time has a resolution of 8 minutes - 32 seconds (512 seconds) and a maximum value of 582 hours (12 bits). The delay time value is set with the LOGDEL System parameter, while the Delay time counter starts counting when the device enter in WAIT mode.

The delay time can also be disabled and an external push button at the DIN pin can be used for starting the logging procedure. When in the WAIT state, a pull-up current is supplied to DIN. A falling edge on DIN manually causes a transition from WAIT mode to ACTIVE mode.

Manual Log Start

In addition to the delayed Start Log, the application can start the logging manually (without a RFID reader). The manual control can be of 2 types:

1. To manually execute the transaction from WAIT to ACTIVE mode. When in WAIT mode, a pull-up current is supplied to DIN pin. A falling edge on DIN, for instance generated by an external button, manually cause the transaction.
2. To manually execute a logging event when the device is in ACTIVE mode. When in ACTIVE mode, a pull-up current is supplied to DIN pin. A falling edge on DIN, for instance generated by an external button, manually cause the logging event.

During ACTIVE mode, a pull-up current is supplied to DIN, so the only required external component is the button. A falling edge on DIN generates a logging event and the logging will be started.

Logging Mode Data Formats

The data formats for the various logging modes are shown in Figures 16 to 20. The start address for the Measured (logged) data is determined by APPBLKS. If APPBLKS = 0 the start address for Measured data is byte address 0x004. Note each new measurement is added in the memory from right to left with the LSB of the next measurement starting at the first free bit from the right immediately next to the previous measurement.

Figure 16:
One Measurement

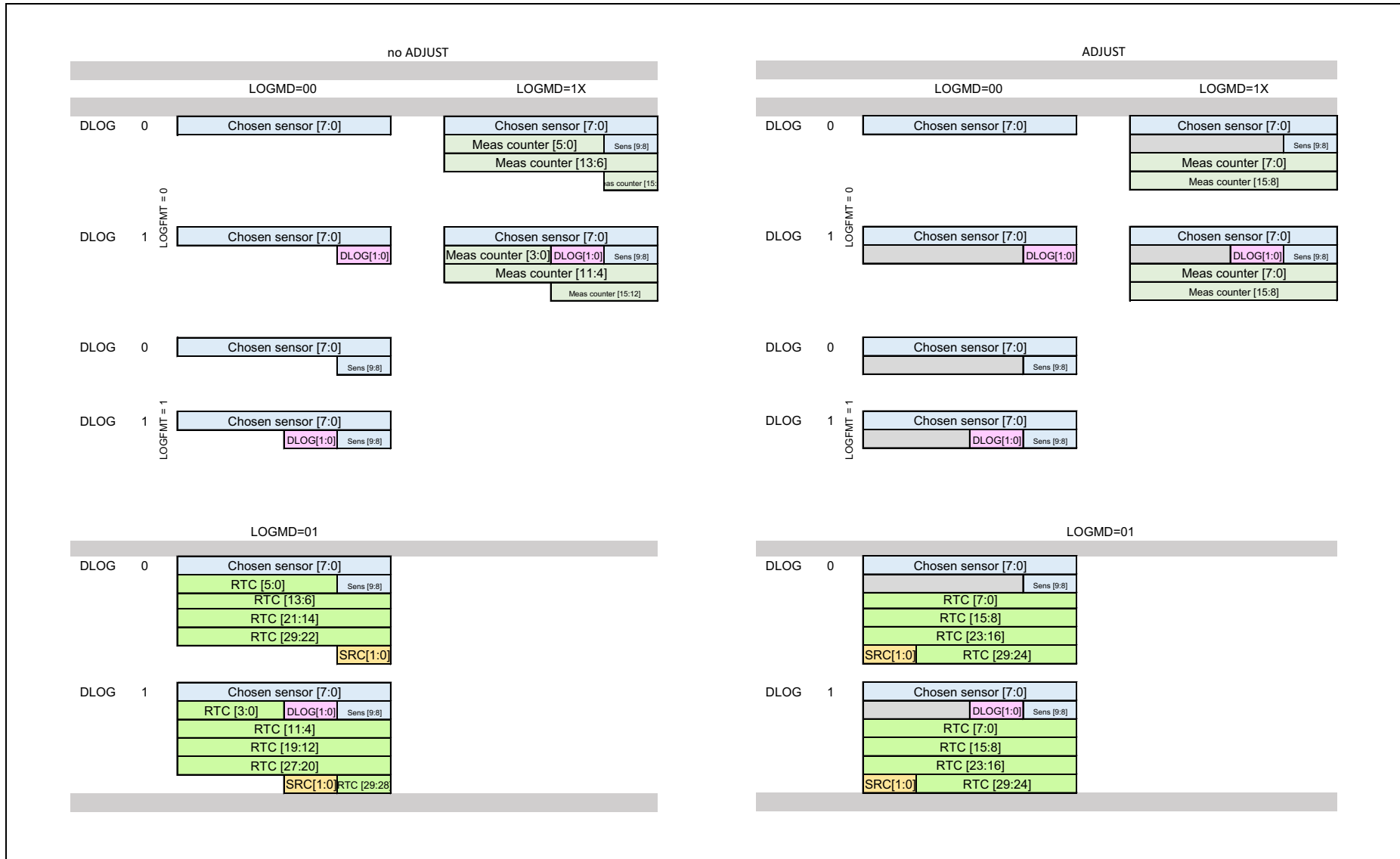

Figure 17:
One Sensor + Battery

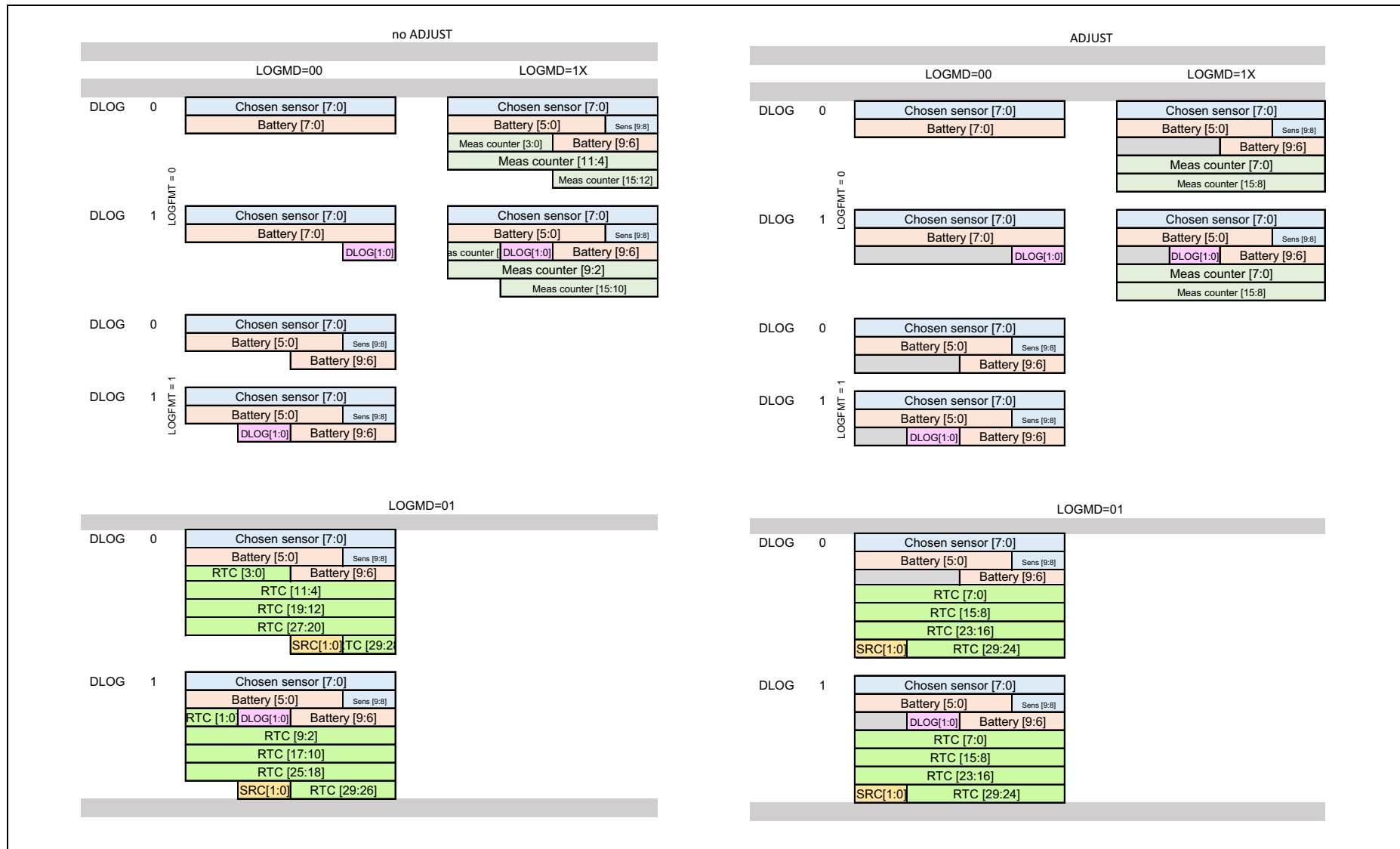

Figure 18:
Two Sensors No Battery

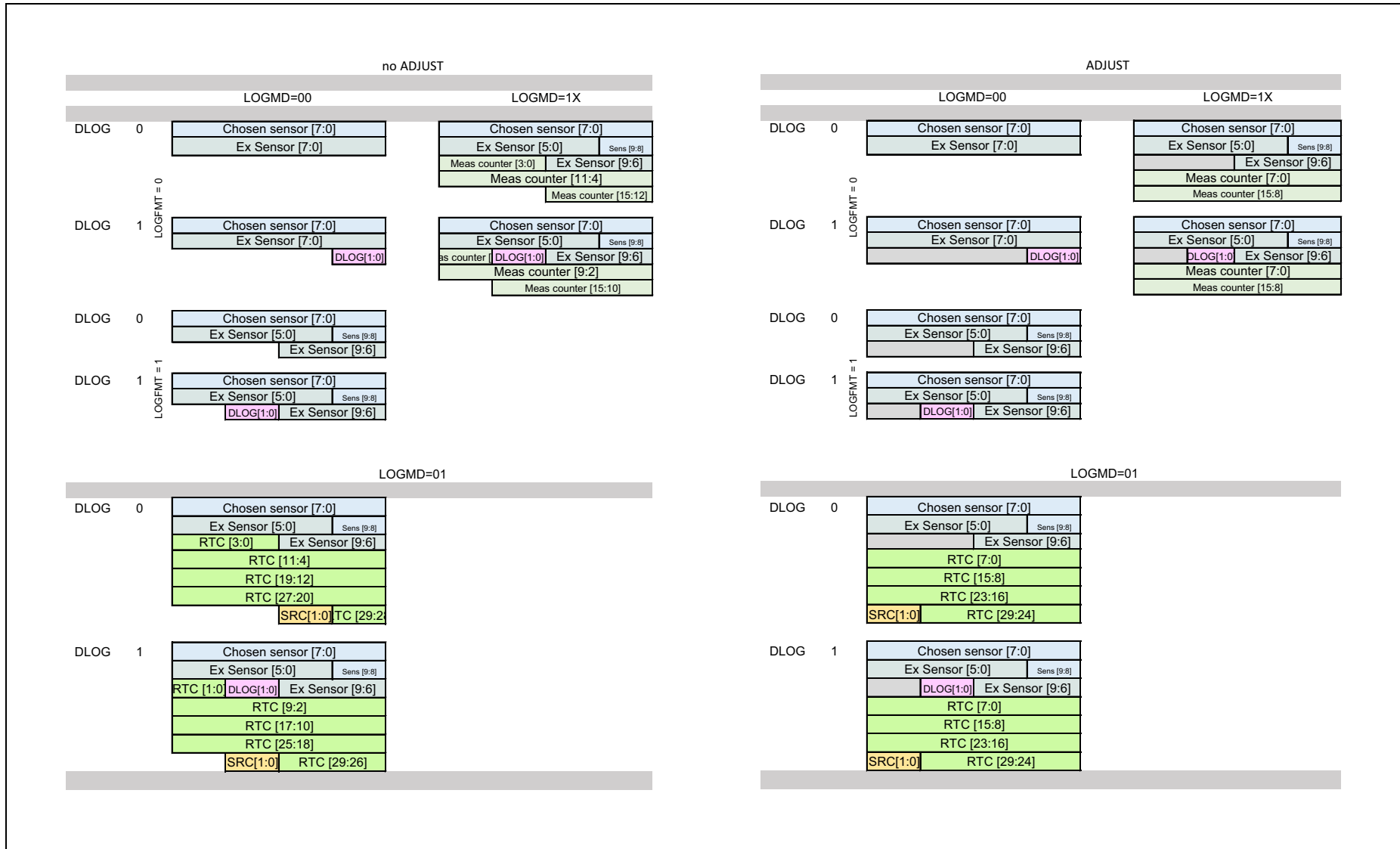

Figure 19:
Two Sensors + Battery

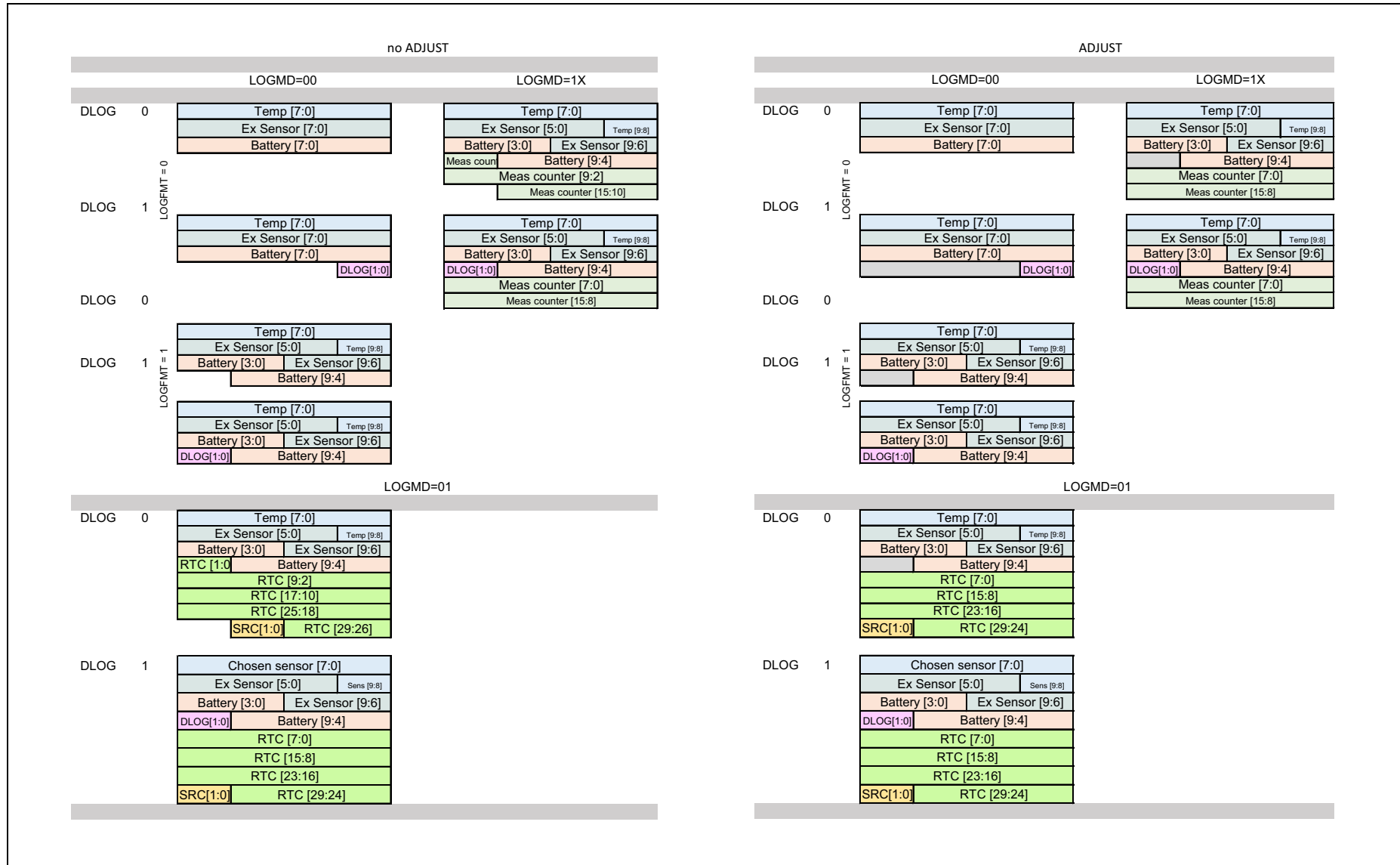
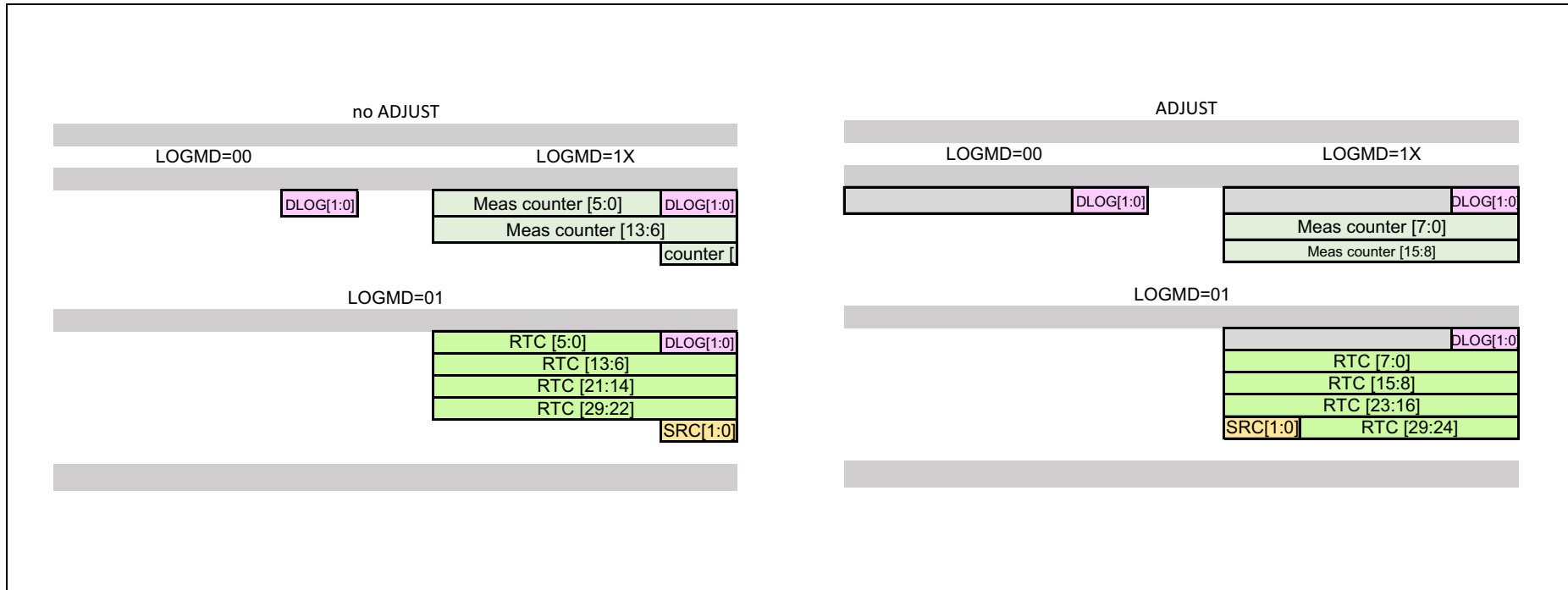

Figure 20:
DLog Only



Analog to Digital Conversion

This section describes how to compute the ADC output code that will result from a sensor input. A block diagram of the sensor interface and ADC is shown in [Figure 21](#).

Figure 21:
Sensor Interface and ADC Block Diagram

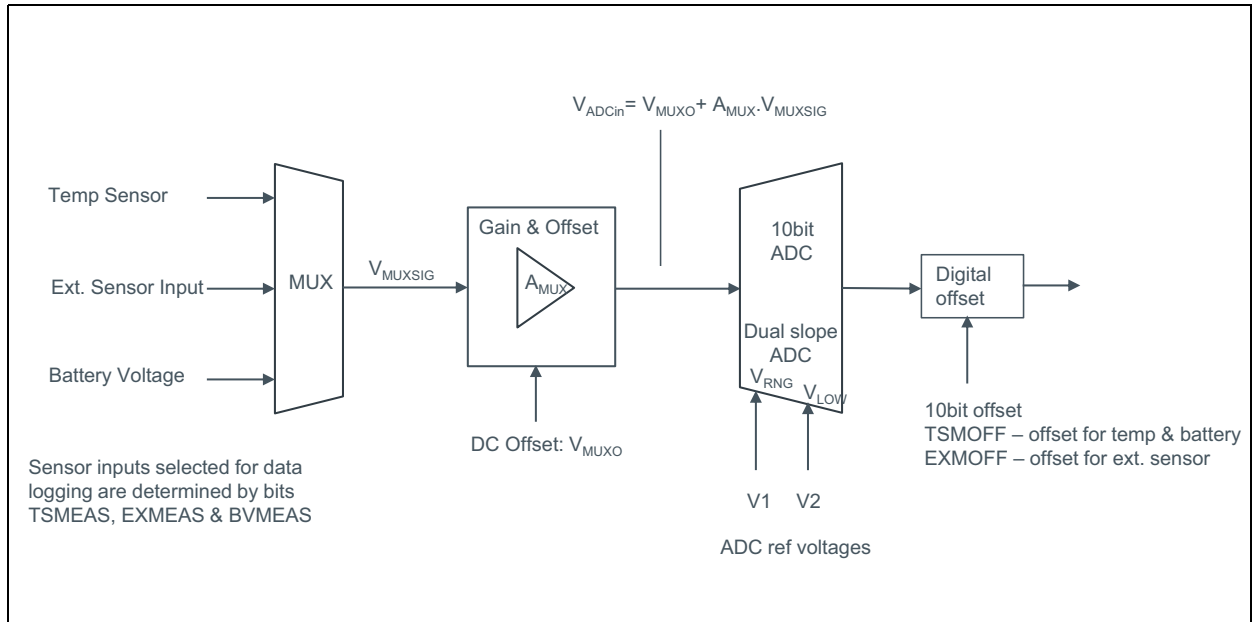
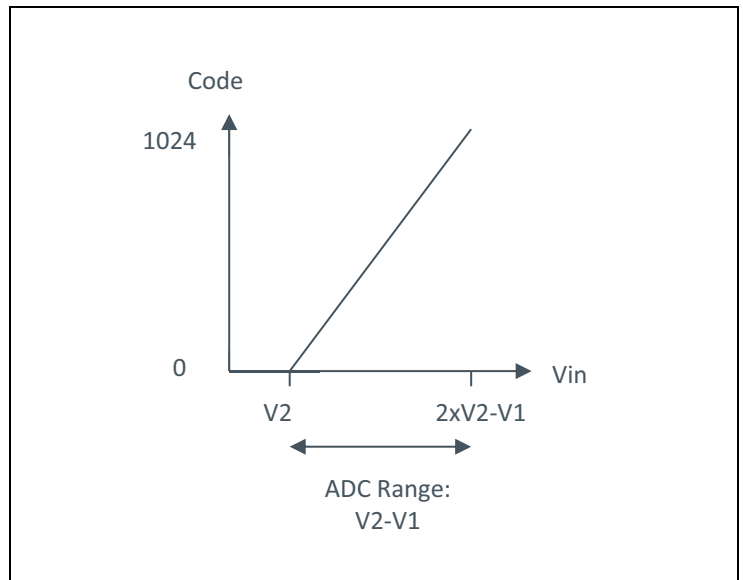

Figure 22:
ADC Input-Output Characteristic



Reference Voltage Generator

There are two programmable reference voltages used in the AS39513 sensor system, V_1 and V_2 . In a trimmed device, these voltages are

$$(EQ1) \quad V_1 = V_{STEP}(3.2 + V1SET)$$

$$(EQ2) \quad V_2 = V_{STEP}(5.2 + V2SET)$$

Where V_{STEP} is 50mV, and V1SET, V2SET values are determined by the measurement type according to the [Figure 23](#) below. The range of possible V1 and V2 ADC reference voltages are shown in [Figure 24](#). If the temperature range is changed from the default by changing TV1SET and/or TV2SET the chip will need recalibrating to produce new trim values. The same is valid for EV1SET, EV2SAT.

ADC input voltage range: $V_2 \leq V_{in} \leq 2V_2 - V_1$

Note this has the consequence that TV2SET must be set to be $\geq TV1SET - 1$ so that the ADC input signal range $V_2 - V_1$ is positive. Similarly EV2SET must be set so that $EV2SET \geq EV1SET - 1$.

Figure 23:
ADC Reference Voltage (defaults shown in brackets)

Value	Measurement Type		
	Temperature	External	Battery
V1SET	TV1SET[2:0] (3'b010)	EV1SET[2:0] (3'b010)	(3'b000)
V2SET	TV2SET[2:0] (3'b011)	EV2SET[2:0] (3'b101)	(3'b001)

Figure 24:
ADC Reference Voltages Versus V1SET, V2SET Values

V1SET	V1	V2SET	V2
0	160mV	0	260mV
1	210mV	1	310mV
2	260mV	2	360mV
3	310mV	3	410mV
4	360mV	4	460mV
5	410mV	5	510mV
6	460mV	6	560mV
7	510mV	7	610mV

ADC Scaling

The selected sensor input (temperature or battery or ext. sensor) is passed through a buffer amplifier and then to the ADC. The buffer amplifier has a selectable gain and offset. The ADC then takes this buffered signal in combination with the selected reference voltages and produces an output code between 0 and 1023.

The first step in computing the ADC code is to determine the source of the gndv1 setting and the mux_gain setting. They depend on the type of measurement according to the table below.

Figure 25:
ADC Scaling (defaults shown in brackets)

Value	Measurement Type		
	Temperature	External	Battery
gndv1	TSV1G (1'b0)	EXV1G (1'b0)	1
mux_gain	2'b00	EXGAIN (2'b00)	2'b00

The parameters gndv1 and mux_gain determine the value of the voltage and gain constants V_{LOW} , V_{RNG} , V_{MUXO} , and A_{MUX} according to the table below.

Figure 26:
ADC Voltage and Gain Constants

User Defined		V_{LOW}	V_{RNG}	V_{MUXO}	A_{MUX}	Comments
mux_gain	gndv1					
00	0	V_2	V_1	0	1	Defaults for temp and ext. sensor input
00	1	V_2	0	0	1	Defaults for battery
01	0	V_2	V_1	$2V_1$	-1	
01	1	V_2	0	$2V_1$	-1	
1x	0	V_2	V_1	$\frac{4}{3}V_1$	$-\frac{1}{3}$	
1x	1	V_2	0	$\frac{4}{3}V_1$	$-\frac{1}{3}$	

These constants in turn are used to calculate the effective ADC offset and scale factor, V_{ZERO} and V_{SCALE} , where

$$(EQ3) \quad V_{ZERO} = \frac{V_{LOW} - V_{MUXO}}{A_{MUX}}$$

$$(EQ4) \quad V_{SCALE} = \frac{V_{LOW} - V_{RNG}}{A_{MUX}}$$

The ADC output code, n_{ADC} , will then be

$$(EQ5) \quad n_{ADC} = 1024 \frac{V_{SIG} - V_{ZERO}}{V_{SCALE}}$$

$$(EQ6) \quad V_{SIG} = (n_{ADC} \cdot V_{SCALE}) / 1024 + V_{ZERO}$$

where V_{SIG} is the voltage of the selected multiplexer signal ($V_{SIG,TEMP}$, $V_{SIG,EXT}$, $V_{SIG,BAT1}$, or $V_{SIG,BAT2}$).

Since the ADC voltage ranges for various settings can overlap, it is often not obvious which are the optimum settings for a given sensor voltage range. An Excel spreadsheet entitled "AS39513 ADC Settings.xlsx" has been developed which shows the effect of the ADC references and sensor configuration settings on the temperature and external sensor input ranges.

ADC Output and Range for Temperature Measurement

The temperature sensor produces a signal voltage that is given by the formula

$$(EQ7) \quad V_{SIG, TEMP} = \frac{T + 273.15}{601.3}$$

where T is the device temperature in degrees Celsius.

Various temperature ranges are possible for the on-chip temperature sensor with different settings of TV1SET and TV2SET (mux_gain and gndv1 are always 00 and 0 respectively for temperature measurements). The nominal default temperature range with TV1SET=2, TV2SET=3 (implies ADC reference voltages VRNG=V1= 260mV VLOW=V2=410mV) is -26.5°C to 63.5°C. Accuracy of the temperature sensor is ±0.5°C over -20°C to 10°C. Possible temperature ranges are shown in [Figure 27](#).

Figure 27:
Temperature Ranges Possible with Different TV1SET and TV2SET Values

TV1SET	TV2SET	Temperature °C		
		Start	End	Range
0	3	-26.6	123.6	150.2
1	3	-26.6	93.5	120.1
2	3	-26.6 ⁽²⁾	63.5	90.1
3	3	-26.6	33.5	60.1
4	3	-26.6	3.5	30.1
2	4	3.5	123.6	120.1
3	4	3.5	93.6	90.1
4	4	3.5	63.5	60
5	4	3.5	33.5	30
4	5	33.5	123.6	90.1
5	5	33.5	93.6	60.1
6	5	33.5	63.6	30.1
6	6	63.6	123.7	60.1
7	6	63.6	93.6	30

Note(s):

1. Colored row indicated default range.
2. The temperature sensor has a temperature range starting at -26.6°C, but the chip operating temperature range restricts the lower limit to -20°C. The default upper limit of the temperature sensor is guaranteed 55°C minimum and nominally 63.5°C. The upper limit may be lower than the nominal 63.5°C due to calibration, but an upper limit of 55°C is guaranteed.

ADC Output and Range for Battery Measurement

The battery sensor uses a voltage divider that depends on the battery type. If the battery type is set to a single cell battery, the signal voltage is

$$(EQ8) \quad V_{SIG, BAT1} = \frac{V_{BAT}}{2.688}$$

Where VBAT is the voltage at the VBAT pin.

If the battery type is set to a dual cell battery, the signal voltage is

$$(EQ9) \quad V_{SIG, BAT2} = \frac{V_{BAT}}{5.452}$$

The configuration settings for battery measurement are V1SET= 3'b000, V2SET=3'b001 mux_gain=00 and gndv1=1 which translates to ADC reference voltages of VRNG=0 and VLOW=V2=310mV.

ADC Output and Range for External Sensor Measurement

The external sensor is just a switch to the SEXT pin, so the signal voltage, VSIG, EXT, is just the voltage at the SEXT pin.

The configuration settings for ext. sensor measurement are EV1SET= 3'b010, EVSET2= 3'b101 mux_gain=00 and gndv1=0 which translates to ADC reference voltages of VRNG=V1=260mV and VLOW=V2=510mV. This translates to an SEXT input voltage range 510 – 760mV

Figure 28:
ADC Input/Output Characteristic for Ext. Sensor Measurement with Default Settings

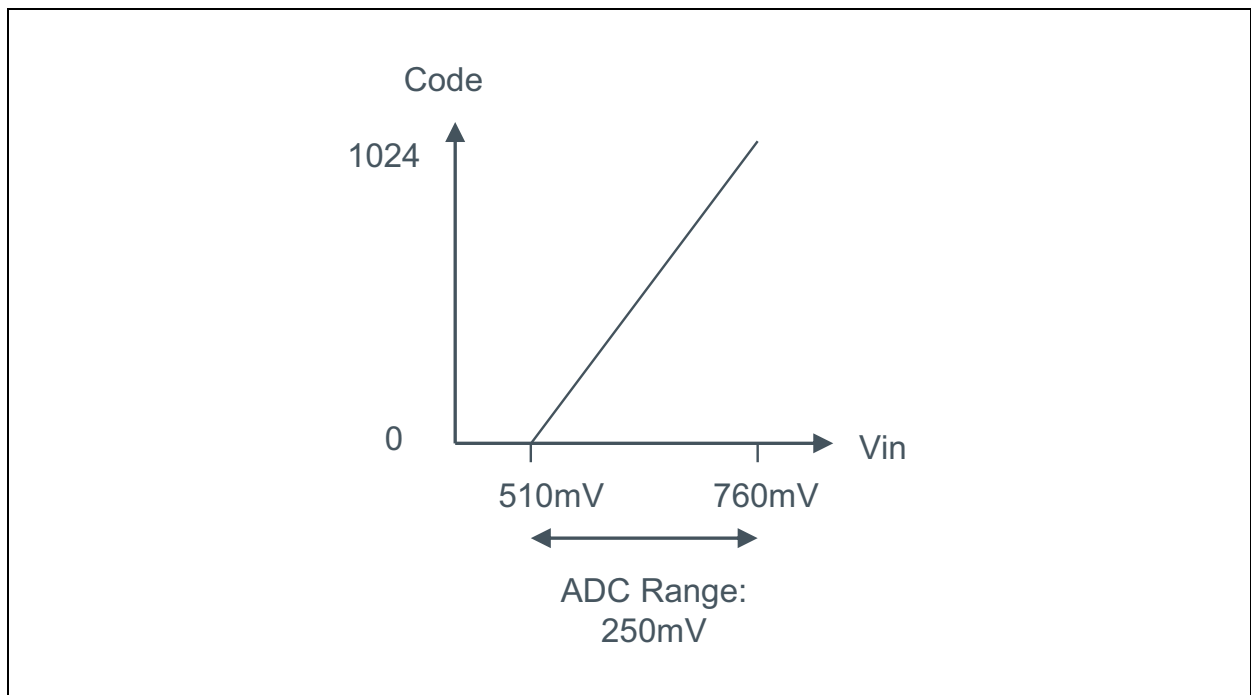

GPIO

When the SPI is not used (CE open or low), the DIN and DOUT pins can be used as general purpose I/Os (unless the SPI direct command “Set IO Mode” has locked the device in SPI mode).

The functions of the DIN can be programmed as follows according to the System parameter DIMD[1:0] stored in the “Logging Control Parameters” address 0x439 (bits 1- 0) in the EEPROM:

Figure 29:
DIN Functional Options (GPIO)

Bit 1	Bit 0	I/O	Structure	Function
0	0	Input	Pull-down	CMOS input, non-inverting 100k ohm pull down to ground enabled.
0	1	Input	Pull-up	Pull-up current is supplied to DIN only during a logging event.
1	0	Input	Pull-up	When in the WAIT state, a pull-up current is supplied to DIN. A falling edge on DIN manually causes a transition from WAIT mode to ACTIVE mode. If TMSRT is also 1, the event that happens first (delay or DIN input) causes the transition from WAIT mode to ACTIVE mode.
1	1	Input	Pull-up	During ACTIVE mode, a pull-up current is supplied to DIN. A falling edge on DIN generates a logging event.

When CE is high, DOUT is used as part of the SPI. When CE is low and the IO mode is set using the Direct SPI command 'Set IO Mode' to Application mode, then the function of DOUT can be configured by DOMD[1:0] and DOSCR[1:0].

The functions of the DOUT can be programmed as follows according to the System parameter DOMD[1:0] stored in the "Logging Control Parameters" address 0x439 (bits 5- 4) in the EEPROM:

Figure 30:
DOMD[1:0]: DOUT Functional Options (GPIO)

Bit 5	Bit 4	I/O	Structure	Function
0	0	Output	CMOS output	CMOS (push-pull) output (this setting is used in SPI mode)
0	1	Output	Pull-up	Pull-up output
1	0	Output	Pull-down output	DOUT is inverted relative to DOSRC description below
1	1	Output	High impedance	High impedance (disconnected) output. Default value.

DOSRC [1:0] stored in the "Logging Control Parameters" address 0x439 (bits 7- 6) in the EEPROM:

Figure 31:
DOSRC[1:0]: DOUT Functional Options When Used As a Pull-Down Output

Bit 7	Bit 6	Function
0	0	DOUT is a copy of the external interrupt comparator output.
0	1	DOUT is high when an ISO 15693 command has been recognized and is being processed.
1	0	DOUT is high when the RF field is available
1	1	DOUT is the logical OR of EEFULL, ADCERR, LOWBAT, and OVLIM. If OSCEN=1, the output is AND'd with a modulated signal that is 1/32 second high (32 counts of osc1k) and 31/32 second low (992 counts of osc1k).

Memory Map

The EEPROM memory as well as registers share a common 11-bit memory space.

From the related 11-bit address it is then possible to access the EEPROM as well as the register and moreover it is possible to know which Access level is required to access each memory area.

By decoding the address MSBs is possible to determine both the type of hardware (EEPROM or registers) and the access level required (Application, Measurement, System, or Factory).

The overall memory layout is described in the figure shown below.

Figure 32:
Memory Map Layout

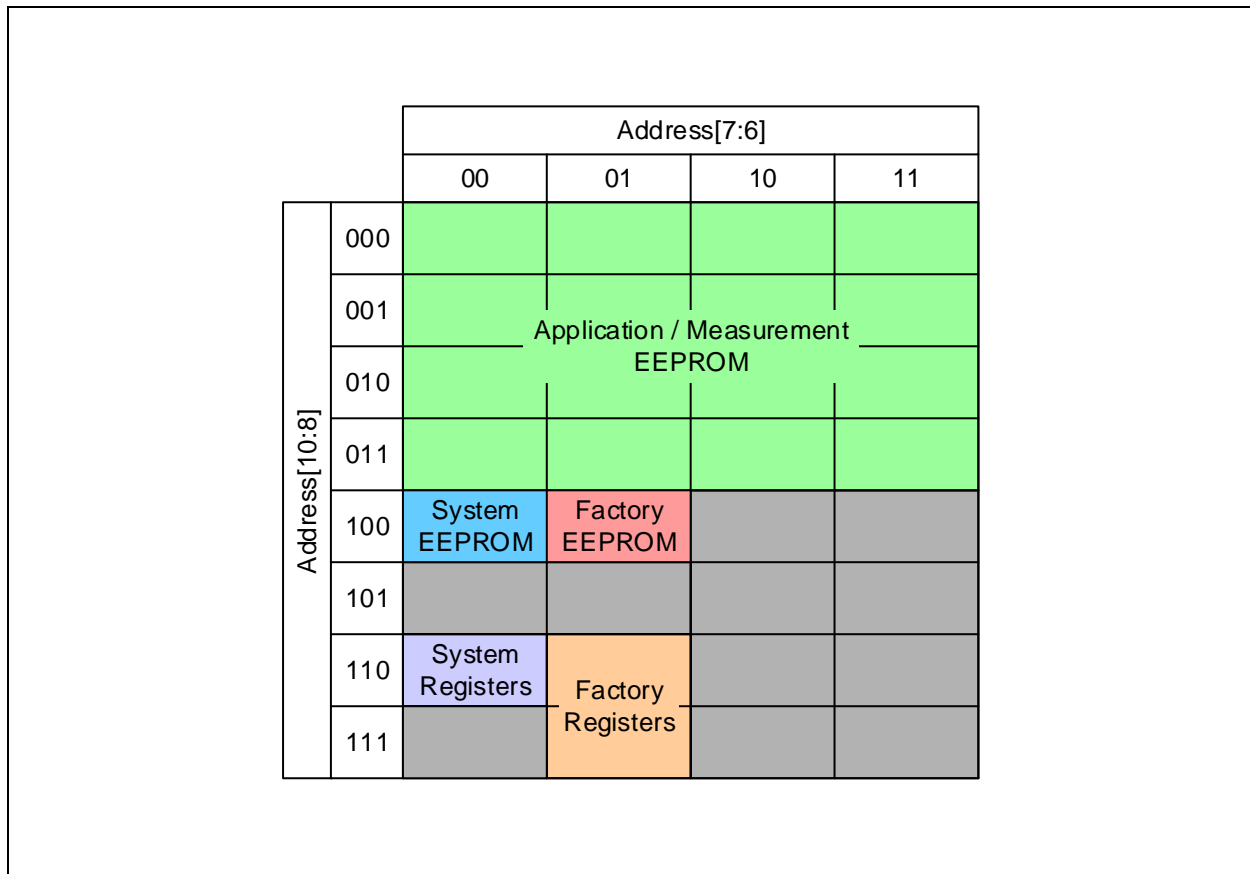

The gray regions in this memory map duplicate other regions to simplify address decoding.

The decoding of the address MSBs can discriminate the addressed memory area as follows:

- **EEPROM area with Application or Measurement access level**

If the Address[10] is 0 then the addressed memory area is EEPROM and the access level is either Application or Measurement. The boundary between the Application and Measurement regions is determined by the number of four-byte memory blocks, APPBLKS parameter, described later in this section.

- **EEPROM area with System or Factory access level**

If the Address[10:9] is 2'b10 then the addressed memory is the upper part of the EEPROM.

If the Address[6] is 0, the access level is System, and if Address[6] is 1, the access level is Factory.

The Address[8:7] is simply ignored and treated as if those two bits were 0.

- **Registers area with System or Factory access level**

If the Address[10:9] is 2'b11, the memory hardware is registers in the logic.

If the Address[6] is 0, the access level is System, and if the Address[6] is 1, the access level is Factory.

The Address[7] is ignored and treated as if it were 0.

The section below describes the memory access levels in more detail. The remaining sections in this chapter describe the parameters in the System and Factory regions of the memory map, one 16-byte page at a time.

Memory Access Levels

Every address in the memory map is assigned to one of four types of access levels: Application, Measurement, System, and Factory. The properties of each access level are described in this section and shown in [Figure 33](#).

Figure 33:
Memory Map

Memory Area	Location	Contents	RFID Access	SPI Access
Application	0x000 -4*APPBLKS[7:0]+3	Application data not logged data	Readable by RFID. Writeable by RFID if Application access has been granted through Set Access	Read/Write by SPI
Measurement	4*APPBLKS[7:0]+4 to 0x3FF	Logged data	Readable by RFID. Writeable by RFID if Measurement access has been granted through Set Access	Read/Write by SPI
System	See Memory Map Layout	System-level parameters (e.g. logging start time, logging interval & limits), data pointers, and other control settings.	Readable by RFID. Writeable by RFID if System access has been granted through Set Access	Read/Write by SPI
Factory	See Memory Map Layout	Calibration info, passwords, memory lock bits etc. Examples are UID, real time and system oscillator trim values	Lock bits can be set but not read through the RF interface using the Lock Block command but otherwise not accessible through the RF interface.	Readable through SPI Writeable through SPI if Factory access is active.

Application Access Region

The Application access region is for application parameters that are protected from data logging. This region begins at byte address 0x000 and ends at byte address 4*APPBLKS[7:0] + 3. This region is readable by both the RFID and SPI memory access commands. It is writeable through RFID only if Application access has been granted through the Set Access command. It is always writeable through the SPI.

Measurement Access Region

The Measurement access region is for data logging. If APPBLKS[7:0] is not 8'd255, this region begins at address $4 * \text{APPBLKS}[7:0] + 4$ and ends at address 0x3FF. (If APPBLKS[7:0] equals 8'd255, there is no Measurement region.) This region is readable by both the RFID and SPI memory access commands. It is writeable through RFID only if Measurement access has been granted through the Set Access command. It is always writeable through the SPI. The logging functions do not need Measurement access in order to write to this region; the Measurement access is only required for direct writing via the RFID interface.

System Access Region

The System access region is for system-level calibration parameters, data pointers, and other control settings. This region is readable by both the RFID and SPI memory access commands. It is writeable through the RFID interface only if System access has been granted through the Set Access command. It is always writeable through the SPI.

There are two sub-regions of System access. The EEPROM region is from address 0x400 through 0x43F. All values in this region are readable and writable with the correct access.

The second sub-region of System access is the mirrored registers. It is for EEPROM parameters that are read and copied into registers at startup. This region is from address 0x600 through 0x63F. All values in this region are write-only (with the correct access). All bytes in this region will read back as 0x00 (with no error).

Factory Access Region

The Factory access region is for factory-only calibration parameters and control settings, as well as password storage and memory lock bits. The region is not accessible through the RFID interface. Attempts to write to this region through the RFID interface will generate a password error. Reads through the RFID interface will simply read 0x00 for each byte with no error. The Factory access regions are readable through the SPI, but are only writeable if Factory access is active.

Factory access is made active by writing a special hard-coded Factory access password using the SPI direct command “Factory Access”. If Factory access is not open, SPI writes to Factory access area will simply be ignored.

There are three sub-regions of Factory access.

The first sub-region is the EEPROM region from address 0x440 through 0x47F. All values in this region are readable and writable via the SPI with the correct access.

The second sub-region of Factory access is the mirrored registers. It is for EEPROM parameters that are read and copied into registers at startup. This region is from address 0x640 through 0x67F. All values in this region are write-only (with the correct access). All bytes in this region will read back as 0x00 (with no error).

The third sub-region of Factory access is the volatile registers. These registers are used for factory level parameters that are not duplicated in the EEPROM and require access through the memory map. This region goes from address 0x740 through 0x77F. All values are writeable with the correct access. No addresses in this region are readable; they all read back as 0x00 with no error.

The remaining sections in this chapter describe the parameters in the System and Factory regions of the memory map, one 16-byte page at a time.

System EEPROM

Global System Parameters

The System EEPROM page from addresses 0x400 through 0x40F contains several global use System parameters. All have the standard System level access through RFID and SPI.

Figure 34:
Global System Parameters

Addr.	RFID Block	Bit							
		7	6	5	4	3	2	1	0
0x400	0x00	STIME[7:0]							
0x401		STIME[15:6]							
0x402		STIME[23:16]							
0x403		STIME[31:24]							
0x404	0x01	DSFID[7:0]							
0x405		AFI[7:0]							
0x406		APPBLKS[7:0]							
0x407									
0x408	0x02	LOGDEL[7:0]							
0x409						LOGDEL[11:8]			
0x40A		LOGINT[7:0]							
0x40B		LOGINT[15:8]							
0x40C	0x03	MEASCNT[7:0]							
0x40D		MEASCNT[15:8]							
0x40E		SKIP16	STRMD						
0x40F									

STIME[31:0] – Start time. This 32-bit value can be used to mark the start time for logging. It is not used internally by the AS39513, so its format can be application dependent.

DSFID[7:0] – Data storage format identifier. This value is written by the Write DSFID command and read back as part of the Get System Info command.

AFI[7:0] – Application family identifier. This value is written by the Write AFI command and is read back as part of the Get System Info command.

APPBLKS[7:0] – Number of four-byte memory blocks in Application memory minus 1. APPBLKS = 255 means 256 Application blocks and no Measurement blocks. APPBLKS = 0 means 1 Application block and 255 Measurement blocks. The measurement logging will begin at address {1'b0, APPBLKS + 1, 2'b00}, assuming APPBLKS < 255.

LOGDEL[11:0] – Logging delay before first logging event. Wait 512*LOGDEL seconds after power-up initialization to begin logging.

LOGINT[15:0] – Logging interval, in seconds, between timer-generated logging events. If LOGINT is set to zero, no logging is performed.

MEASCNT[15:0] – Measurement count. This value is incremented with each logging event, even if the limit thresholds caused the measurements not to be recorded to EEPROM.

STRMD – Storage mode.

0 = Normal logging. When the logging memory is full, additional logging values will be lost.

SKIP16 – Update counts only every 16 measurements.

0 = MEASCNT, MEASPTR, and status byte (0x43B) updated every measurement.

1 = MEASCNT, MEASPTR, and status byte (0x43B) updated every 16 measurements, when MEASCNT[3:0] = 4'b1111.

Temperature Sensor Parameters

The temperature sensor parameter EEPROM page from addresses 0x410 through 0x41F contains parameters used during temperature logging. All have the standard System level access through RFID and SPI.

Figure 35:
Temperature Sensor Parameters

Addr.	RFID Block	Bit							
		7	6	5	4	3	2	1	0
0x410	0x04	TXHILIM[7:0]							
0x411		TXLOLIM[7:0]							
0x412		THILIM[7:0]							
0x413		TLOLIM[7:0]							
0x414	0x05	TXHICNT[7:0]							
0x415		TXLOCNT[7:0]							
0x416		THICNT[7:0]							
0x417		TLOCNT[7:0]							
0x418	0x06	THIMAX[7:0]							
0x419		TLOMAX[7:0]							
0x41A									
0x41B									
0x41C	0x07								
0x41D									
0x41E									
0x41F									

TXHILIM[7:0] – First threshold to use for limit checks during temperature measurements. See the section on [Limit Check Algorithm](#) above.

TXLOLIM[7:0] – Second threshold to use for limit checks during temperature measurements. See the section on [Limit Check Algorithm](#) above.

THILIM[7:0] – Third threshold to use for limit checks during temperature measurements. See the section on [Limit Check Algorithm](#) above.

TLOLIM[7:0] – Fourth threshold to use for limit checks during temperature measurements. See the section on [Limit Check Algorithm](#) above.

TXHICNT[7:0] – Counter for the number of times that the first threshold condition was met during limit checks of the temperature measurement. If this count is non-zero, the over limit count flag, OVLIM, will be set.

TXLOCNT[7:0] – Counter for the number of times that the second threshold condition was met (but not the first condition) during limit checks of the temperature measurement. If this count is non-zero, the over limit count flag, OVLIM, will be set.

THICNT[7:0] – Counter for the number of times that the third threshold condition was met (but not the first or second condition) during limit checks of the temperature measurement.

TLOCNT[7:0] – Counter for the number of times that the fourth threshold condition was met (but not the first, second, or third condition) during limit checks of the temperature measurement.

THIMAX[7:0] – Maximum count for the number of times that the third threshold condition was met (but not the first or second condition) during limit checks of the external sensor measurement. If THICNT > THIMAX, then the over limit count flag, OVLIM, will be set.

TLOMAX[7:0] – Maximum count for the number of times that the fourth threshold condition was met (but not the first, second, or third condition) during limit checks of the external sensor measurement. If TLOCNT > TLOMAX, then the over limit count flag, OVLIM, will be set.

External Sensor Parameters

The external sensor parameter EEPROM page from addresses 0x420 through 0x42F contains parameters used during external sensor logging. All have the standard System level access through RFID and SPI.

Figure 36:
External Sensor Parameters

Addr.	RFID Block	Bit							
		7	6	5	4	3	2	1	0
0x420	0x08	EXHILIM[7:0]							
0x421		EXLOLIM[7:0]							
0x422		EHILIM[7:0]							
0x423		ELOLIM[7:0]							
0x424	0x09	EXHICNT[7:0]							
0x425		EXLOCNT[7:0]							
0x426		EHICNT[7:0]							
0x427		ELOCNT[7:0]							
0x428	0x0A	EHIMAX[7:0]							
0x429		ELOMAX[7:0]							
0x42A									
0x42B									
0x42C	0x0B								
0x42D									
0x42E									
0x42F									

EXHILIM[7:0] – First threshold to use for limit checks during external sensor measurements. See the section on [Limit Check Algorithm](#) above.

EXLOLIM[7:0] – Second threshold to use for limit checks during external sensor measurements. See the section on [Limit Check Algorithm](#) above.

EHILIM[7:0] – Third threshold to use for limit checks during external sensor measurements. See the section on [Limit Check Algorithm](#) above.

ELOLIM[7:0] – Fourth threshold to use for limit checks during external sensor measurements. See the section on [Limit Check Algorithm](#) above.

EXHICNT[7:0] – Counter for the number of times that the first threshold condition was met during limit checks of the external sensor measurement. If this count is non-zero, the over limit count flag, OVLIM, will be set.

EXLOCNT[7:0] – Counter for the number of times that the second threshold condition was met (but not the first condition) during limit checks of the external sensor measurement. If this count is non-zero, the over limit count flag, OVLIM, will be set.

EHICNT[7:0] – Counter for the number of times that the third threshold condition was met (but not the first or second condition) during limit checks of the external sensor measurement.

ELOCNT[7:0] – Counter for the number of times that the fourth threshold condition was met (but not the first, second, or third condition) during limit checks of the external sensor measurement.

EHIMAX[7:0] – Maximum count for the number of times that the third threshold condition was met (but not the first or second condition) during limit checks of the external sensor measurement. If $EHICNT > EHIMAX$, then the over limit count flag, OVLIM, will be set.

ELOMAX[7:0] – Maximum count for the number of times that the fourth threshold condition was met (but not the first, second, or third condition) during limit checks of the external sensor measurement. If $ELOCNT > ELOMAX$, then the over limit count flag, OVLIM, will be set.

Logging Control Parameters

The logging control parameter EEPROM page from addresses 0x430 through 0x43F contains parameters used during logging and other system controls. All have the standard System level access through RFID and SPI. This page is copied to registers at 0x630 through 0x63F during device initialization. After initialization, if an EEPROM write occurs to these addresses either from the RFID or SPI interface, the corresponding register in the 0x630 through 0x63F page is also updated. In addition, the status byte 0x43D is updated at the end of a logging event.

Figure 37:
Logging Control Parameters

Addr.	Default Settings								RFID Block	Bit							
	7	6	5	4	3	2	1	0		7	6	5	4	3	2	1	0
0x430	0	1	0						0x0C	TV1SET[2:0]			TV1TRIM[4:0]				
0x431	0	1	1							TV2SET[2:0]			TV2TRIM[4:0]				
0x432										TSMOFF[6:0]							
0x433							0			TSV1G							
0x434	0	1	0						0x0D	EV1SET[2:0]			EV1TRIM[4:0]				
0x435	1	0	1							EV2SET[2:0]			EV2TRIM[4:0]				
0x436										EXMOFF[6:0]							
0x437						0	0	0				EXGAIN[1:0]		EXV1G			
0x438	0	0	0	0	0		0	0	0x0E	HILIM	LOPOR	ADJUST	CPHLD	OSCEN		TMIEN	TMSRT
0x439	0	0	1	1		0	0	0		DOSRC[1:0]		DOMD[1:0]			DLOG	DIMD[1:0]	
0x43A			0	0	0	0	1	1				BCKSEL[1:0]		BTYPE[2:0]		BATCHK	
0x43B	0	0	0	0	0	0	0	0		EXCPR	LOGFMT	LOGMD[1:0]		EIEN	EXMEAS	BVMEAS	TSMEAS
0x43C	0	0	0	0	0	0	0	0	0x0F	EXCSET[4:0]				EICUR	EXIVSET[1:0]		
0x43D	0	0	0	0	0	0		0		ACTIVE	EEFULL	OVRT	ADCERR	LOWBAT	ACTPOR		OVLIM
0x43E	0	0	0	0	0	0	0	0		MEASPTR[7:0]							
0x43F	0				0	0	0	0		WAKEMD				MEASPTR[11:8]			

TV1TRIM[2:0] – Signed binary value. Trims the ADC reference voltage V1 used during temperature and battery measurements. See the section [Analog to Digital Conversion](#) for more details.

TV1SET[2:0] – Reference levels for the ADC during temperature measurements. The condition $TV2SET \geq TV1SET-1$ must be fulfilled to ensure the ADC input range $V2-V1$ is positive.

Note if the temperature range is changed the temperature sensor will need recalibration. See the section [Analog to Digital Conversion](#) for more details.

TV2TRIM[2:0] – Signed binary value. Trims the ADC reference voltage V2 used during temperature and battery measurements. See the section [Analog to Digital Conversion](#) for more details.

TV2SET[2:0] – Reference levels for the ADC to use during temperature measurements. The condition $TV2SET \geq TV1SET-1$ must be fulfilled to ensure the ADC input range $V2-V1$ is positive. Note if the temperature range is changed the temperature sensor will need recalibration. See the section [Analog to Digital Conversion](#) for more details.

TSMOFF[6:0] – Offset to use during temperature and battery measurements. This value is a twos-compliment signed value. It is sign-extended to 10 bits and added to the ADC result after a temperature or battery measurement.

TSV1G – V1 ground setting (trf_gndv1_o) to use during temperature measurements.

EV1TRIM[2:0] – Signed binary value. Trims the ADC reference voltage V1 used during external sensor measurements. See the section [Analog to Digital Conversion](#) for more details.

EV1SET[2:0] – Reference levels for the ADC to use during external sensor measurements. The condition $EV2SET \geq EV1SET-1$ must be fulfilled to ensure the ADC input range $V2-V1$ is positive. See the section [Analog to Digital Conversion](#) for more details.

EV2TRIM[2:0] – Signed binary value. Trims the ADC reference voltage V2 used during external sensor measurements. See the section [Analog to Digital Conversion](#) for more details.

EV2SET[2:0] – Reference levels for the ADC to use during external sensor measurements. The condition $EV2SET \geq EV1SET-1$ must be fulfilled to ensure the ADC input range $V2-V1$ is positive. See the section [Analog to Digital Conversion](#) for more details.

EXMOFF[6:0] – Offset to use during external sensor measurements. This value is a twos-compliment signed value. It is sign-extended to 10-bits and added to the ADC result after an external sensor measurement.

EXV1G – V1 ground setting (trf_gndv1_o) to use during external sensor measurements.

EXGAIN[1:0] – Multiplexer gain setting (mux_gain_o) to use during external sensor measurements.

TMSRT – Use delay timer (with LOGDEL) to transition from WAIT mode to ACTIVE mode.

0 = Do not use delay timer. If DIMD is not 2'b10, WAIT mode transitions directly to ACTIVE mode with no delay.

1 = Use the delay timer. If DIMD is 2'b10, the event that happens first (delay or DIN input) causes the transition from WAIT mode to ACTIVE mode.

TMIEN – Timer interrupt enable.

0 = No timer generated logging events.

1 = Generate logging events with the LOGINT delay.

OSCEN – Real-time oscillator enable. The real-time oscillator must be enabled for any of the real-time delays above to be of use. It can be disabled to further reduce power consumption in applications that do not need timing based interrupts or log time tracking.

0 = Disable real-time oscillator.

1 = Enable real-time oscillator.

CPHLD – Enable charge-pump hold feature of the sensor charge pump.

0 = Disable charge-pump hold.

1 = Enable charge-pump hold.

ADJUST – Adjust logging information to an even byte boundary after logging.

0 = No adjustment. Logging information is maximally packed in spite of byte boundaries.

1 = Each logging event ends at a byte boundary. Only values within the same logging event are packed.

LOPOR – Control RF POR threshold.

0 = Use default higher POR threshold.

1 = Use lower POR threshold.

HILIM – Control RF limiter threshold.

0 = Use default lower limiter threshold.

1 = Use higher limiter threshold.

DIMD[1:0] – Input mode for DIN pin (when not in SPI communication).

2'b00 = CMOS input, non-inverting 100k ohm pull down to ground enabled.

2'b01 = Digital sensor input with pull up. Pull-up current is supplied to DIN only during a logging event.

2'b10 = Use the DIN pin for startup. When in the WAIT state, a pull-up current is supplied to DIN. A falling edge on DIN manually causes a transition from WAIT mode to ACTIVE mode. If TMSRT is also 1, the event that happens first (delay or DIN input) causes the transition from WAIT mode to ACTIVE mode.

2'b11 = Use the DIN pin for a logging interrupt. During ACTIVE mode, a pull-up current is supplied to DIN. A falling edge on DIN generates a logging event.

DLOG – Add the digital input and external sensor interrupt values to the data that is logged. The two-bit value { din_i, extirq_i } is added to the logging data.

0 = No status logging of the digital input and external sensor interrupt.

1 = Add logging of the digital input and external sensor interrupt.

DOMD[1:0] – Digital output mode (when not in SPI communication).

2'b00 = CMOS (push-pull) output.

2'b01 = Pull-up output.

2'b10 = Pull-down output. DOUT is inverted relative to DOSRC description below.

2'b11 = High impedance (disconnected) output. Default.

DOSRC[1:0] – Digital output source (when not in SPI communication).

2'b00 = DOUT is a copy of the external interrupt comparator output.

2'b01 = DOUT is high when an ISO 15693 command has been recognized and is being processed.

2'b10 = DOUT is high when the RF field is available.

2'b11 = DOUT is the logical OR of EEFULL, ADCERR, LOWBAT, and OVLIM. If OSCEN=1, the output is AND'd with a modulated signal that is 1/32 second high (32 counts of osc1k) and 31/32 second low (992 counts of osc1k).

BATCHK – Battery check at the start of logging.

0 = No battery check.

1 = Do a battery check in order to qualify the logging.

It is recommended to leave battery check enabled.

BTYP[2:0] – Battery type algorithm to use.

3'b000 = Battery voltage is assumed to be nominally 1.5 V.

3'b001 = Battery voltage is assumed to be nominally 3.0 V.

If the BTYP value is changed for example from 3V type to 1.5V type, the new BTYP value will only take effect after the next power up of the chip. The temperature sensor accuracy is only guaranteed if the chip is operated with a battery corresponding to the BTYP it was tested with.

BCKSEL[1:0] – Battery compare threshold. Threshold also depends on whether the battery is a 3 V or 1.5 V type as determined by the BTYP[2:0] above. This is mapped directly to bchk_sel_o. When BTYP is set for 1.5V batteries, BCKSEL can only have the default value BCKSEL[1:0] = 00. Please see [Figure 11](#) for the battery check threshold values.

TSMEAS – Enable temperature sensor logging.

0 = No temperature measurements.

1 = During logging, temperature measurements are made and optionally recorded depending on the logging mode.

BVMEAS – Enable an ADC measurement of the battery voltage.

0 = No ADC measurement of the battery voltage is made or logged.

1 = Enable ADC measurement and logging of the battery voltage.

EXMEAS – Enable external sensor logging.

0 = No external sensor measurements.

1 = During logging, external sensor measurements are made and optionally recorded depending on the logging mode.

EIEN – Enable external sensor interrupt.

0 = No external sensor interrupt.

1 = External sensor interrupt can trigger a logging event. Interrupt will be triggered when the voltage on the SEXT pin falls below the threshold defined by EXIVSET. Interrupt is falling-edge sensitive, so the SEXT pin must rise above the threshold before an additional sensor interrupt can be triggered.

LOGMD[1:0] – Logging mode for all sensors.

2'b00 – Dense mode. Logging will occur for all logging events. No measurement count or real-time clock values will be logged.

2'b01 – Interrupt mode. Logging will occur for all logging events. Sensors are always logged to 10-bit accuracy. The real-time clock value and interrupt source are logged. The interrupt source is a two-bit value: 2'b01 = external sensor interrupt, and 2'b10 = DIN interrupt.

2'b10 – Normal limit mode. Enable logging if any of the limit check conditions are met. Sensors are always logged to 10-bit accuracy. If a measurement is logged, the value of the measurement counter is also logged.

2'b11 – Limit crossing mode. Enable logging only if one of the limit check conditions is different than that from the previous logging event. Sensors are always logged to 10-bit accuracy. If a measurement is logged, the value of the measurement counter is also logged.

LOGFMT – Logging format.

0 = Only the 8 MSB's of the 10-bit ADC result for each measurement are logged. This is only valid when LOGMD = 2'b00. For other values of LOGMD, 10 bits are always used.

1 = All 10 bits of the ADC result for each measurement are logged.

EXCPR – Use compressed format for external sensor.

0 = Uncompressed ADC result used.

1 = An 8-bit compressed version of the 10-bit ADC result is logged. (This is only valid when LOGMD = 2'b00 and LOGFMT = 0.)

The compression algorithm for the result `ex_res_ff[9:0]` is as follows:

Figure 38:
Compression Algorithm

Condition	Compressed Result
<code>ex_res_ff[9] = 1</code>	{ 2'b11, <code>ex_res_ff[8:3]</code> }
<code>ex_res_ff[9:8] = 2'b01</code>	{ 2'b10, <code>ex_res_ff[7:2]</code> }
<code>ex_res_ff[9:7] = 3'b001</code>	{ 2'b01, <code>ex_res_ff[6:1]</code> }
Otherwise	{ 2'b00, <code>ex_res_ff[5:0]</code> }

EXIVSET[1:0] – Voltage threshold for external interrupt. This value is mapped directly to `exi_vset_o[1:0]`. See the description of the External Sensor Interrupt circuits for more information. The threshold voltages are given in the table below, where `vdda` is the digital supply voltage.

Figure 39:
Voltage Threshold for External Interrupt

EXIVSET[1:0]	Voltage Threshold
2'b00	vdda * 0.256
2'b01	vdda * 0.083
2'b10	vdda * 0.355
2'b11	vdda * 0.438

EICUR – Enable the current drive for the external sensor interrupt. This is independent of the EXCSET current source and is only used if EIEN = 1.

0 = Disable external sensor interrupt current.

1 = Enable current drive for external sensor interrupt if EIEN = 1.

EXCSET[4:0] – Current drive select for external sensor measurement. This current is only active during the external sensor measurement. It is not used when the AS39513 is in low power mode waiting for an interrupt or timer event. This value is mapped directly to trf_iset_o[4:0]. See the description of the Trimmed Reference circuit for more information.

OVLIM – Limit count threshold exceeded.

0 = No limit count thresholds exceeded.

1 = One of the eight limit count thresholds have been exceeded.

ACTPOR – Active wakeup after power-up reset.

0 = The AS39513 has not had a reset direct to ACTIVE mode event.

1 = The AS39513 has had a power on reset occur when WAKEMD = 1 and ACTIVE = 1.

LOWBAT – Low battery condition.

0 = No low battery condition measured.

1 = The battery check operation (BATCHK = 1) resulted in a low battery indication.

ADCERR – ADC error flag.

ADCERR is a flag in system EEPROM which is set by an under or overflow of the ADC during logging measurements. Once set it remains set until the system EEPROM bit is cleared by a write command to system EEPROM memory. The ADCERR flag is not set by an ADC under or overflow during a Do Measurement command.

0 = No ADC error has occurred.

1 = An ADC error has occurred, either from an input signal out of range or a poorly chosen combination of reference voltage settings.

OVWRT – Measurement overwrite flag.

0 = No measurements have been overwritten.

1 = At least one measurement has been overwritten.

EEFULL – The EEPROM is full.

0 = More measurements can be logged.

1 = At least one measurement was not logged due to a lack of EEPROM space.

ACTIVE – Controller state.

0 = Controller is in the IDLE or WAIT modes.

1 = Controller is in the ACTIVE mode.

MEASPTR[11:0] – Measurement pointer. The EEPROM value is the pointer value at the end of a logging operation. The register copy of this measurement pointer will also be updated with each EEPROM write during logging so that it always points to the next logging location. The upper 10 bits of this 12-bit value is the address in the Application and Measurement EEPROM area to which to write. The two LSB's represent the current bit position. The logging values are all 2, 6, 8, or 10-bit values, so they will always fall on one of the four two-bit boundaries in a byte.

WAKEMD – Wakeup mode.

0 = The AS39513 always reinitializes after a power-up reset but the MEASCNT and MEASPTR values in EEPROM from any previous data logging will be retained as long as the chip stays in idle mode.

1 = The AS39513 will skip to ACTIVE mode after a power-up reset if ACTIVE = 1.

Factory EEPROM

Factory Trim and RFID Parameters

The factory trim and RFID parameter EEPROM page from addresses 0x440 through 0x44F contains trim parameters to be loaded during initialization and RFID factory-set parameters. These values cannot be accessed through the RFID interface unless noted in the field descriptions below. They can be read through the SPI interface. They can be written through the SPI interface if the Factory access password has been entered previously using an SPI direct command. Bytes 0x440 through 0x443 are copied to registers at 0x640 through 0x643 during device initialization. After initialization, if an SPI EEPROM write occurs to the addresses 0x440 through 0x443, the corresponding register in the 0x640 through 0x643 address range is also updated.

Figure 40:
Factory Trim and RFID Parameters

Addr.	Bit							
	7	6	5	4	3	2	1	0
0x440	OSCTRIM[7:0]							
0x441	LKALL				ROSTRIM[4:0]			
0x442				VOTRIM[4:0]				
0x443					TSEINTRIM[3:0]			
0x444								
0x445								
0x446							AFI_LK	DSF_LK
0x447	CHIPREV[7:0]							
0x448	UID[7:0]							
0x449	UID[15:8]							
0x44A	UID[23:16]							
0x44B	UID[31:24]							
0x44C	UID[39:32]							
0x44D	UID[47:40]							
0x44E	UID[55:48]							
0x44F	UID[63:56]							

OSCTRIM[7:0] – Real-time oscillator trim setting. This value is mapped directly to `osc_trim_o[7:0]`. See the description of the Real-Time Oscillator for more information.

ROSTRIM[7:0] – High-speed ring oscillator trim setting. This value is mapped directly to `ros_trim_o[4:0]`. See the description of the High-Speed Oscillator for more information.

LKALL – Lock all memory. If set, this bit will prevent all Measurement EEPROM from being written directly through RFID commands. Logging events will still be able to write to the Measurement memory.

0 = Lock setting depends on individual block lock bits.

1 = Lock all EEPROM Measurement areas from RFID writes.

VOTRIM[4:0] – Main voltage trim setting for the trimmed reference.

TSEINTRIM[3:0] – Temperature sensor bandgap slope trim. This value is mapped directly to `tsen_trim_o[3:0]`. See the description of the Temperature Sensor for more information.

DSF_LK – Lock the data storage format identifier. This bit can be set through the Lock DSFID command.

0 = The Write DSFID command can change the DSFID value.

1 = The Write DSFID command cannot change the DSFID value.

AFI_LK – Lock the application family identifier. This bit can be set through the Lock AFI command.

0 = The Write AFI command can change the AFI value.

1 = The Write AFI command cannot change the AFI value.

CHIPREV[7:0] – The chip revision identifier. This value can be read through the Get System Info RFID command.

8'h11 = AS39513 v2.0.

UID[63:0] – The unique RFID identifier. This value can be read through the Get System Info RFID command.

Passwords

The passwords EEPROM page from addresses 0x450 through 0x45F contains the System, Application, and Measurement passwords. The RFID interface can only access these values through the Set Access and Set Password commands described above. They can be read through the SPI interface. They can be written through the SPI interface if the Factory access password has been entered previously.

**Figure 41:
Passwords**

Addr.	Bit							
	7	6	5	4	3	2	1	0
0x450	SYSPW[7:0]							
0x451	SYSPW[15:8]							
0x452	SYSPW[23:16]							
0x453	SYSPW[31:24]							
0x454	APPPW[7:0]							
0x455	APPPW[15:8]							
0x456	APPPW[23:16]							
0x457	APPPW[31:24]							
0x458	MEASPW[7:0]							
0x459	MEASPW[15:8]							
0x45A	MEASPW[23:16]							
0x45B	MEASPW[31:24]							
0x45C								
0x45D								
0x45E								
0x45F								

SYSPW[31:0] – System access password.

APPPW[31:0] – Application access password.

MEASPW[31:0] – Measurement access password.

Memory Lock Bits

The memory lock bits EEPROM pages from addresses 0x460 through 0x47F contain the individual lock status for each EEPROM block in the Application and Measurement area. As described above, the AS39513 has an 11-bit memory map address space. Let the address space for the Application and Measurement EEPROM be represented by the fields below.

Figure 42:
Address Space for the Application and Measurement EEPROM

Bit	10	9	8	7	6	5	4	3	2	1	0
Address	0	AGROUP[4:0]				ABLSB[2:0]				ABYTE[1:0]	

For the Application and Memory areas, Address[10] is always 0. These areas are broken into 256 blocks of four bytes each. The RFID read and write commands work on a block-by-block basis. The 8-bit block address is the concatenation: { AGROUP[4:0], ABLSB[2:0] }. Each block can be individually locked from writing via the RFID write commands by setting one of the memory lock bits in the EEPROM. The EEPROM address containing the memory lock bit for a given block is at the address $0x460 + \text{AGROUP}$. The bit index to lock the block is ABLSB. For example to lock the block containing the memory address 0x13A, for which AGROUP = 5'b01001, ABLSB = 3'b110, and ABYTE = 2'b10, the RFID Lock Block command writes a 1 to bit 6 in EEPROM address 0x469. The RFID Write Block command must check that the corresponding lock bit is not set before writing to that block.

The RFID interface can only access the memory lock bits through the Lock Block command described above. They can be read through the SPI interface. They can be written through the SPI interface if the Factory access password has been entered previously.

System Registers

Mirrored System Registers

The addresses 0x630 through 0x63F access registers whose values are copied from the EEPROM addresses 0x430 through 043F during device initialization. After initialization, if an EEPROM write occurs to the addresses 0x430 through 0x43F, either from the RFID or SPI interface, the corresponding register in the 0x630 through 0x63F page is also updated.

The mirrored system register values cannot be accessed directly through the RFID interface. They can be written directly through the SPI interface. Writing directly to the address locations 0x630 through 0x63F only changes the register value; it does not change the EEPROM value. It is intended that the register values will be changed directly during system or factory calibration, and then the final values will be written into EEPROM when the calibration is complete. These registers cannot be read. Reading bytes from these address locations just returns 0x00.

Figure 43:
Mirrored System Registers

Addr.	Bit							
	7	6	5	4	3	2	1	0
0x630	TV1SET[2:0]			TV1TRIM[4:0]				
0x631	TV2SET[2:0]			TV2TRIM[4:0]				
0x632	TSMOFF[6:0]							
0x633								TSV1G
0x634	EV1SET[2:0]			EV1TRIM[4:0]				
0x635	EV2SET[2:0]			EV2TRIM[4:0]				
0x636	EXMOFF[6:0]							
0x637						EXGAIN[1:0]		EXV1G
0x638	HILIM	LOPOR	ADJUST	CPHLD	OSCEN		TMIEN	TMSRT
0x639	DOSRC[1:0]		DOMD[1:0]			DLOG	DIMD[1:0]	
0x63A			BCKSEL[1:0]		BTYPE[2:0]			BATCHK
0x63B	EXCPR	LOGFMT	LOGMD[1:0]		EIEN	EXMEAS	BVMEAS	TSMEAS
0x63C	EXCSET[4:0]					EICUR	EXIVSET[1:0]	
0x63D	ACTIVE	EEFULL	OVWRT	ADCERR	LOWBAT	ACTPOR		OVLIM
0x63E	MEASPTR[7:0]							
0x63F	WAKEMD				MEASPTR[11:8]			

For descriptions of all of these parameters, see [Logging Control Parameters](#).

Factory Registers

Mirrored Factory Registers

The addresses 0x640 through 0x643 access registers whose values are copied from the EEPROM addresses 0x440 through 0443 during device initialization. After initialization, if an EEPROM write occurs to the addresses 0x440 through 0x443, the corresponding register in the 0x640 through 0x643 address range is also updated.

The mirrored factory register values cannot be accessed directly through the RFID interface. They can also be written through the SPI interface if Factory access is open. Writing to the address locations 0x640 through 0x643 only changes the register value; it does not change the EEPROM value. It is intended that the register values will be changed directly during factory calibration, and then the final values will be written into EEPROM when the calibration is complete. These registers cannot be read. Reading bytes from these address locations just returns 0x00.

Figure 44:
Mirrored Factory Registers

Addr.	Bit							
	7	6	5	4	3	2	1	0
0x640	OSCTRIM[7:0]							
0x641	LKALL			ROSTRIM[4:0]				
0x642				VOTRIM[4:0]				
0x643					TSENRIM[3:0]			

For descriptions of all of these parameters, see [Factory Trim and RFID Parameters](#).

RFID Commands

All of the RFID commands for the AS39513 follow the standard ISO15693 format. In general, each command has a request and a response. When powered, the RFID interface has three possible states: ready, quiet, and selected, as specified in the ISO15693 standard.

Figure 45:
ISO15693 State Diagram

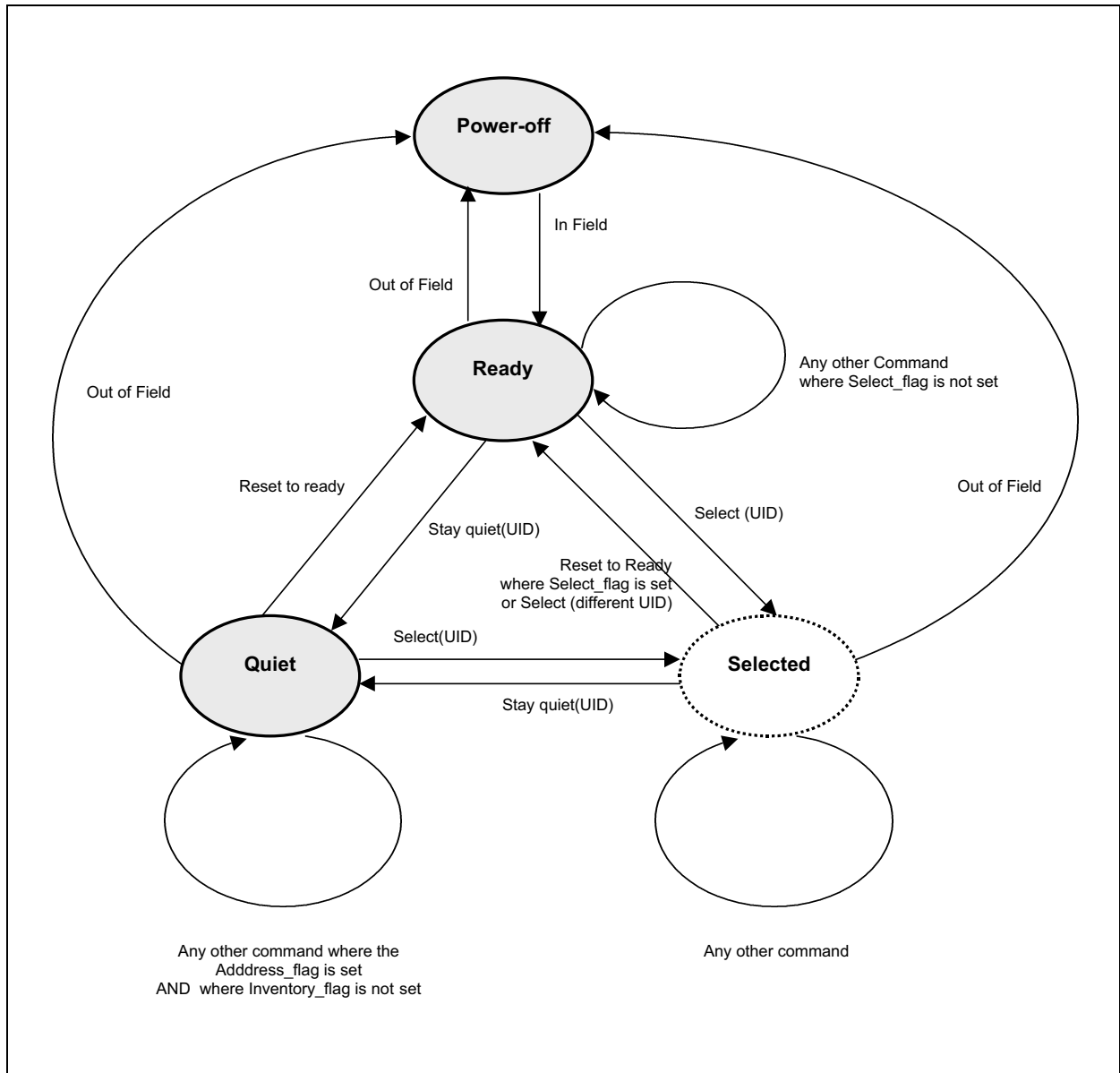

Note(s):

1. Duplicate of ISO15693-3 selected state diagram

Request Command Structure

The Request Command Structure from the Reader is:

SOF	Flags	Command Code	UID	Parameters	Data	CRC	EOF
	8 bits	8 bits	64 bits	n*8 bits	m*8 bits	16 bits	

where SOF is the ISO15693 start-of-frame, the Flags are the protocol control flags described below, the command code determines which command is being requested, UID is the unique identifier, parameters and data are zero or more bytes depending on the command, the CRC is the error check code, which is calculated in accordance with ISO15693-3 and EOF is the ISO15693 end-of-frame. The UID can be present or not present depending on the Flags settings.

For the custom commands (command codes 0xA0 through 0xDF), the command code field will be followed immediately by an IC manufacturing code, which for the AS39513 is 0x36 for legacy reasons.

Flags

There are two types of request command flags used in ISO15693: inventory flags (abbreviated IFLAGS) and non-inventory flags (abbreviated NFLAGS). Their formats are as follows.

The Inventory Flags are:

Bit	7	6	5	4	3	2	1	0
IFLAGS	0	OPTION	NBSLOTS	AFI	0	1	DRATE	SUBCAR

where:

SUBCAR – Sub-carrier selection.

0 = Use a single sub-carrier frequency in the response.

1 = Use two sub-carriers in the response.

DRATE – Data rate selection.

0 = Use low data rate.

1 = Use high data rate.

AFI – AFI field usage. Only 0 (no AFI field) is supported in the AS39513.

NBSLOTS – Number of anti-collision slots.

0 = 16 slots.

Inventory Command Flags

Figure 46:
Inventory Command Flags

Flag Bits	Flag Name	Bit Value Meaning	
		0	1
b0	SUBCAR	Single	Double
b1	DRATE	Low	High
b2	Inventory	X	1 for inventory
b3	Protocol ext.	Always 0	RFU
b4	AFI	Always 0	Not supported
b5	NBSLOTS	16 slots	1 slot
b6	OPTION	Always 0	RFU
b7	RFU	Always 0	RFU

The Non-Inventory Flags are:

Bit	7	6	5	4	3	2	1	0
NFLAGS	0	OPTION	ADDR	SELECT	0	0	DRATE	SUBCAR

where:

SUBCAR – Sub-carrier selection.

0 = Use a single sub-carrier frequency in the response.

1 = Use two sub-carriers in the response.

DRATE – Data rate selection.

0 = Use low data rate.

1 = Use high data rate.

SELECT – Use selected or addressed tag.

0 = Command request will be executed according to the ADDR bit.

1 = Command request will be executed only if the AS39513 RFID interface is in the “select” state. The ADDR bit should be 0, and the UID field is not included in the request.

ADDR – Addressing mode.

0 = Request is not addressed. The UID field is not used. The AS39513 always responds to the request.

1 = Request is address to a specific UID. The UID field is used, and the AS39513 responds only if its UID matches that in the command request.

OPTION – Command option flag. The meaning of this bit depends on the command. If the command description below does not specify a meaning for this bit, this flag is ignored.

Non-Inventory Command Flags

Figure 47:
Non-Inventory Command Flags

Flag Bits	Flag Name	Bit Value Meaning	
		0	1
b0	SUBCAR	Single	Double
b1	DRATE	Low	High
b2	Inventory	0	X
b3	Protocol ext.	Always 0	RFU
b4	SELECT	All tags	Selected tag
b5	ADDR	Unaddressed	Addressed
b6	OPTION	Command dependent	Command dependent
b7	RFU	Always 0	RFU

Command Response Structure

The RFID command response structure also follows the standard ISO15693 format.

The Response Structure from the Tag is:

SOF	Flags	Parameters	Data	CRC	EOF
	8 bits	n*8 bits	m*8 bits	16 bits	

where SOF is the ISO15693 start-of-frame, the Flags are the protocol response flags described below, parameters and data are zero or more bytes depending on the command, the CRC is the error check code, and EOF is the ISO15693 end-of-frame.

The Response Flags are:

Bit	7	6	5	4	3	2	1	0
RFLAGS	0	0	0	EXTEN	0	0	0	ERR

Where:

ERR – Error flag.

0 = No error detected.

1 = Error detected. The normal command response parameters and data will be replaced with an 8-bit error code.

EXTEN – Command extension enabled. This will always be 0 in the AS39513.

When an error occurs, the response parameter and data fields will be replaced with a one-byte error code from the list below.

The Response Structure from Tag in Error case is:

SOF	Flags	Error Code	CRC	EOF
	8 bits	8 bits	16 bits	

Figure 48:
Error Handling

Error Code	Description
0x01	Command code invalid or not supported.
0x02	Command not recognized; format error.
0x03	Command option not supported.
0x0F	Unknown error.
0x10	The specified block is not available (doesn't exist).
0x11	The specified block is already locked and cannot be locked again.
0x12	The specified block is already locked and cannot be written.
0xA0	Incorrect password or memory access not opened.
0xA2	Battery measurement error.
0xA3	A/D conversion error.
0xA6	EEPROM collision.

The details of the AS39513 commands are given in the sections below.

Inventory Command

Inventory Command Request:

SOF	Flags	Command	Mask Length	Mask Value	CRC	EOF
	IFLAGS	0x01	8 bits	0 to 64 bits	16 bits	

Inventory Command Reply:

SOF	Flags	DSFID	UID	CRC	EOF
	RFLAGS	8 bits	64 bits	16 bits	

After receiving an inventory request, the AS39513 responds with its data storage format identifier (DSFID) and its 64-bit unique identifier (UID), both of which are stored in EEPROM. One slot and multiple slots for anti-collision are supported. The parameters are a mask length, and a mask value. The mask length is one byte, and valid values are 0 to 60 when 16 slots are used and 0 to 64 when 1 slot is used. The length of the mask value is the number of bits specified in the mask length, rounded up to the nearest integer number of bytes, with the MSBs padded with zeros as needed.

The ISO 15693-3 specification, in section 9.2², describes a modulation ignore time (t_{mit}) after the reception of an EOF from the reader. This is the time for which 10% modulation will be ignored after an EOF sequence. Manufacturers vary as to which commands implement this specification and how the ignore time varies by command. In the AS39513, the t_{mit} parameter is only applied to the Inventory command. No modulation masking is used for any of the other commands.

2. For more information, please refer to the respective section of ISO/IEC 15693-3 specification (second edition, 2009-04-15).

Stay Quiet Command

Stay Quiet Command Request:

SOF	Flags	Command	UID	CRC	EOF
	NFLAGS*	0x02	64 bits	16 bits	

There is no response to the stay quiet command. The stay quiet command must be executed in addressed mode (In NFLAGS, SELECT = 0 and ADDR = 1), so the UID is mandatory. After receiving the stay quiet command, the AS39513 will remain in the quiet state until the device is reset, it receives a select request, or it receives a reset to ready request. In the quiet state, the device will not process any command where IFLAGS are used. It will process an addressed request.

Read Block Command

Read Block Command Request:

SOF	Flags	Command	UID	BADDR	CRC	EOF
	NFLAGS	0x20	64 bits	8 bits	16 bits	

Read Block Command Reply:

SOF	Flags	Security Status	Block Data	CRC	EOF
	RFLAGS	8 bits	4*8 bits	16 bits	

The read block command reads four bytes from the EEPROM's Application and Measurement areas. The starting byte address to read is 4*BADDR. If the OPTION flag is 1, a security status is returned. If the OPTION flag is 0, no security status is returned. In either case, the four bytes in the block are returned, lowest address and LSB first.

The security status will be 0x00 if the block is not locked, and 0x01 if the block is locked either through the lock bits or the LKALL flag.

Write Block Command

Write Block Command Request:

SOF	Flags	Command	UID	BADDR	Block Data	CRC	EOF
	NFLAGS	0x21	64 bits	8 bits	4*8 bits	16 bits	

Write Block Command Reply:

SOF	Flags	CRC	EOF
	RFLAGS	16 bits	

The write block command writes the four bytes of Block Data to the EEPROM's Application and Measurement areas. The starting byte address to write is $4*BADDR$. The block data is sent lowest address and LSB first. In order to be written, the access state must allow access to the block being written, and the block must not have been locked.

The OPTION flag controls the response timing according to the ISO 15693 standard, section 10.4.2³. If the Option flag is set to 1 an error will be sent as the reply.

Lock Block Command

Lock Block Command Request:

SOF	Flags	Command	UID	BADDR	CRC	EOF
	NFLAGS	0x22	64 bits	8 bits	16 bits	

Lock Block Command Reply:

SOF	Flags	CRC	EOF
	RFLAGS	16 bits	

The lock block command sets the bit in System EEPROM to mark as "read-only" the four-byte block beginning at $4*BADDR$. No access passwords need to be set prior to using this command.

The OPTION flag controls the response timing according to the ISO 15693 standard, section 10.4.3³.

3. For more information, please refer to the respective section of ISO/IEC 15693-3 specification (second edition, 2009-04-15).

Read Multiple Blocks Command

Read Multiple Blocks Command Request:

SOF	Flags	Command	UID	BADDR	NUMBLK	CRC	EOF
	NFLAGS	0x23	64 bits	8 bits	8 bits	16 bits	

Read Multiple Blocks Command Reply:

SOF	Flags	Security Status	Block Data	CRC	EOF
	RFLAGS	8 bits	4*8 bits	16 bits	
Repeat as needed					

The read multiple blocks command reads multiple four-byte blocks from the EEPROM's Application and Measurement areas. The command reads NUMBLK+1 of blocks of data starting from block number BADDR. If the OPTION flag is 1, a security status is returned. If the OPTION flag is 0, no security status is returned. In either case, the four bytes in each block are returned, lowest address and LSB first.

The security status will be 0x00 if the block is not locked, and 0x01 if the block is locked.

If the last byte to read would have an address that is greater than 0x3FF, error code 0x10 is returned and no data is read.

Select Command

Select Command Request:

SOF	Flags	Command	UID	CRC	EOF
	NFLAGS	0x25	64 bits	16 bits	

The select command must be executed in addressed mode (In NFLAGS, SELECT = 0 and ADDR = 1), so the UID is mandatory. There are three possible actions for the select command.

1. If the UID in the command is equal to the device UID, the AS39513 will enter the selected state and send the reply:

SOF	Flags	CRC	EOF
	RFLAGS	16 bits	

2. If the UID in the command is different from the device UID, and the device is in the selected state, the AS39513 will return to the ready state and not send a response.
3. If the UID in the command is different from the device UID, and the device is not in the selected state, the AS39513 will remain in its current state (ready or quiet) and not send a response.

Reset-to-Ready Command

Reset-to-Ready Command Request:

SOF	Flags	Command	UID	CRC	EOF
	NFLAGS	0x26	64 bits	16 bits	

Reset-to-Ready Command Reply:

SOF	Flags	CRC	EOF
	RFLAGS	16 bits	

The reset-to-ready command takes the RFID state machine out of the quiet state and moves it into the ready state.

Write AFI Command

Write AFI Command Request:

SOF	Flags	Command	UID	AFI	CRC	EOF
	NFLAGS	0x27	64 bits	8 bits	16 bits	

Write AFI Command Reply:

SOF	Flags	CRC	EOF
	RFLAGS	16 bits	

The write AFI command writes the one byte application family identifier (AFI) to the EEPROM's System area. In order to be written, the access state must allow access to the System memory, and the AFI must not have been locked.

The OPTION flag controls the response timing according to the ISO 15693 standard, section 10.4.8⁴.

Lock AFI Command

Lock AFI Command Request:

SOF	Flags	Command	UID	CRC	EOF
	NFLAGS	0x28	64 bits	16 bits	

Lock AFI Command Reply:

SOF	Flags	CRC	EOF
	RFLAGS	16 bits	

The lock AFI command sets the bit in System EEPROM, AFI_LK, to mark as "read-only" the one-byte AFI value. No access passwords need to be set prior to using this command.

The OPTION flag controls the response timing according to the ISO 15693 standard, section 10.4.9⁴.

4. For more information, please refer to the respective section of ISO/IEC 15693-3 specification (second edition, 2009-04-15).

Write DSFID Command

Write DSFID Command Request:

SOF	Flags	Command	UID	DSFID	CRC	EOF
	NFLAGS	0x29	64 bits	8 bits	16 bits	

Write DSFID Command Reply:

SOF	Flags	CRC	EOF
	RFLAGS	16 bits	

The write DSFID command writes the one byte data storage format identifier (DSFID) to the EEPROM's System area. In order to be written, the access state must allow access to the System memory, and the DSFID must not have been locked.

The OPTION flag controls the response timing according to the ISO 15693 standard, section 10.4.10⁵.

Lock DSFID Command

Lock DSFID Command Request:

SOF	Flags	Command	UID	CRC	EOF
	NFLAGS	0x2A	64 bits	16 bits	

Lock DSFID Command Reply:

SOF	Flags	CRC	EOF
	RFLAGS	16 bits	

The lock DSFID command sets the bit in System EEPROM, DSFID_LK, to mark as "read-only" the one-byte DSFID value. No access passwords need to be set prior to using this command.

The OPTION flag controls the response timing according to the ISO 15693 standard, section 10.4.11⁵.

5. For more information, please refer to the respective section of ISO/IEC 15693-3 specification (second edition, 2009-04-15).

Get System Info Command

Get System Info Command Request:

SOF	Flags	Command	UID	CRC	EOF
	NFLAGS	0x2B	64 bits	16 bits	

Get System Info Command Reply:

SOF	Flags	Info	UID	DSFID	AFI	MemSz	CHIPREV	CRC	EOF
	RFLAGS	0x0F	64 bits	8 bits	8 bits	16 bits	8 bits	16 bits	

The system info command returns a number of the system parameters, including the UID, DSFID, AFI, memory size (MemSz), and chip revision (CHIPREV). The memory size is formatted in a two-byte word as shown below.

Memory Size Format

Bit	15	14	13	12	11	10	9	8	7	6	5	4	3	2	1	0
MemSz	0	0	0	BLOCKSZ[4:0]				BLOCKCNT[7:0]								

where:

BLOCKCNT[7:0] – Number of memory blocks minus 1. 0xFF indicates 256 blocks, 0x00 indicates 1 block.

BLOCKSZ[4:0] – Block size in bytes minus 1. 0x1F indicates a 32-byte block, 0x00 indicates a 1 byte block.

The chip revision is an 8-bit value that is programmed in the EEPROM in production at the factory.

Set Access Command

Set Access Command Request:

SOF	Flags	Command	IC Mfg.	UID	Level	Password	CRC	EOF
	NFLAGS	0xA0	0x36	64 bits	8 bits	4*8 bits	16 bits	

Set Access Command Reply:

SOF	Flags	CRC	EOF
	RFLAGS	16 bits	

The set access command opens a specific type of EEPROM area to be available for writing. Three of the four types of area access can be set with this command: System, Application, and Measurement. (The Factory areas can only be accessed through the SPI, except for limited and specific commands like Set Password and Lock Block.) The access level field, Level, has the format below. Note, it is only necessary to first send a Set Access command before a Write command if the password is non zero for a particular EEPROM area.

Access Level Field

Bit	7	6	5	4	3	2	1	0
Level	0	0	0	0	0	0	ALEV[1:0]	

where:

ALEV[1:0] – Access level.

0 = Not allowed.

1 = System access level.

2 = Application access level.

3 = Measurement access level.

Each access level is independent, and only affects write operations. If the set access command for a given level has the correct 32-bit password, the access for writing to that level is opened. The access remains open until the RF field is removed. (The access will close with the loss of RF field even if the logic is continuously powered by an external battery.)

If the set access command has an incorrect password, an incorrect password error (error code 0xA0) is returned. The default passwords for an unprogrammed device are 0x00000000.

The password values themselves are stored in EEPROM and can be written with the Set Password command below.

Set Password Command

Set Password Command Request:

SOF	Flags	Command	IC Mfg.	UID	Level	Password	CRC	EOF
	NFLAGS	0xA1	0x36	64 bits	8 bits	4*8 bits	16 bits	

Set Password Command Reply:

SOF	Flags	Access	CRC	EOF
	RFLAGS	8 bits	16 bits	

The Access Level Field Level has the Format Below:

Bit	7	6	5	4	3	2	1	0
Level	0	0	0	0	0	0	ALEV[1:0]	

where:

ALEV[1:0] – Access level.

0 = Not allowed.

1 = System access level.

2 = Application access level.

3 = Measurement access level.

The set password command changes the password for the access level specified in ALEV, but only if the access to that level has been opened by the Set Access command. For example, to write the System password, system access must be allowed. If an attempt is made to set a password for an access level that is not open, the AS39513 will respond with an error code 0xA0.

Read System Block Command**Read System Block Command Request:**

SOF	Flags	Command	IC Mfg.	UID	BADDR	CRC	EOF
	NFLAGS	0xA2	0x36	64 bits	8 bits	16 bits	

Read System Block Command Reply:

SOF	Flags	Security Status	Block Data	CRC	EOF
	RFLAGS	8 bits	4*8 bits	16 bits	

The read system block command reads four bytes from the EEPROM and register System areas. The starting byte address to read is $0x400 + 4*BADDR$. If the OPTION flag is 1, a security status is returned. If the OPTION flag is 0, no security status is returned. In either case, the four bytes in the block are returned, lowest address and LSB first.

The security status will always be 0x00 because the System and Factory areas do not have lock bits.

If the block address BADDR corresponds to a Factory access area, the error code 0x10 (specified block not available) will be returned instead of the block data.

Write System Block Command

Write System Block Command Request:

SOF	Flags	Command	IC Mfg.	UID	BADDR	Block Data	CRC	EOF
	NFLAGS	0xA3	0x36	64 bits	8 bits	4*8 bits	16 bits	

Write System Block Command Reply:

SOF	Flags	CRC	EOF
	RFLAGS	16 bits	

The write system block command writes the four bytes of Block Data to the EEPROM and register System areas. The starting byte address to write is $0x400 + 4*BADDR$. The block data is sent lowest address and LSB first. In order to be written, the access state must allow access to the block being written.

The OPTION flag controls the response timing according to the ISO 15693 standard for the Write Block command, section 10.4.2⁶. If the Option flag is set to 1 an error will be sent as the reply.

6. For more information, please refer to the respective section of ISO/IEC 15693-3 specification (second edition, 2009-04-15).

Read Multiple System Blocks Command

Read Multiple System Blocks Command Request:

SOF	Flags	Command	IC Mfg.	UID	BADDR	NUMBLK	CRC	EOF
	NFLAGS	0xA4	0x36	64 bits	8 bits	8 bits	16 bits	

Read Multiple System Blocks Command Reply:

SOF	Flags	Security Status	Block Data	CRC	EOF
	RFLAGS	8 bits	4*8 bits	16 bits	
Repeat as needed					

The read multiple blocks command reads multiple four-byte blocks from the EEPROM and register System areas. The starting byte address to read is $0x400 + 4 * BADDR$. The last byte read will be at the address $0x403 + 4 * (BADDR + NUMBLK)$. If the OPTION flag is 1, a security status is returned. If the OPTION flag is 0, no security status is returned. In either case, the four bytes in each block are returned, lowest address and LSB first.

The security status will always be 0x00 because the System and Factory areas do not have lock bits.

If the block address BADDR corresponds to a Factory access area, the data will simply read back as all zeros with no error.

Lock All Blocks Command

Lock All Blocks Command Request:

SOF	Flags	Command	IC Mfg.	UID	CRC	EOF
	NFLAGS	0xA6	0x36	64 bits	16 bits	

Lock All Blocks Command Reply:

SOF	Flags	CRC	EOF
	RFLAGS	16 bits	

The lock all blocks command sets the LKALL bit in System EEPROM to mark as “read-only” the entire Measurement area of the EEPROM. (The Application area is not locked by this bit.) No access passwords need to be set prior to using this command. The OPTION flag controls the response timing according to the ISO 15693 standard, section 10.4.3⁷.

Set Mode Command

Set Mode Command Request:

SOF	Flags	Command	IC Mfg.	UID	Mode	CRC	EOF
	NFLAGS	0xA8	0x36	64 bits	8 bits	16 bits	

Set Mode Command Reply:

SOF	Flags	CRC	EOF
	RFLAGS	16 bits	

The Set Mode command can change the mode of the chip directly to ACTIVE mode (where logging events can take place) or initially to a WAIT mode (where there is a programmed delay before entering ACTIVE mode). This is the key command to start logging.

7. For more information, please refer to the respective section of ISO/IEC 15693-3 specification (second edition, 2009-04-15).

The Set Mode command sets the controller mode according to the value in the Mode parameter. The format of the Mode parameter is below.

Mode Parameter Format

Bit	7	6	5	4	3	2	1	0
Level	0	0	0	0	0	0	CMODE[1:0]	

where:

CMODE[1:0] – New controller mode.

0 = Go to the Idle mode.

1 = Go to the Wait mode.

2 or 3 = Go to the Active mode.

The OPTION flag controls the response timing in a manner similar to the ISO 15693 standard for the Write Block command, section 10.4.2⁸. If OPTION = 0, the change in mode will occur after the EOF in the command request, using the same delay as in 10.4.2. The response will be at the completion of the mode change, which can vary depending on the transition.

If OPTION = 1, the response will be immediately after the EOF and it will not wait for the completion of the mode transition.

Do Measurement Command

Do Measurement Command Request:

SOF	Flags	Command	IC Mfg.	UID	Meas	CRC	EOF
	NFLAGS	0xA9	0x36	64 bits	8 bits	16 bits	

Do Measurement Command Reply:

SOF	Flags	ADC	CRC	EOF
	RFLAGS	16 bits	16 bits	

8. For more information, please refer to the respective section of ISO/IEC 15693-3 specification (second edition, 2009-04-15).

The do measurement command initiates a specific measurement outside the normal logging loop. The command reply will wait for the ADC conversion to complete. The ADC algorithm will use a mode that always takes the same amount of time for a given oscillator clock frequency, independent of the conversion value. The format of the Meas parameter is below.

Measurement Parameter Format

Bit	7	6	5	4	3	2	1	0
Meas	0	0	0	0	0	0	DOMEAS[1:0]	

where:

DOMEAS[1:0] – Measurement type to initiate.

0 = Do a temperature measurement.

1 = Do a battery level measurement.

2 = Do a sensor measurement.

3 = Reserved; do not use.

Note the Do Measurement -Temperature command results in some self heating of the chip due to the presence of the RF field from the reader, so temperature accuracy cannot be guaranteed with this command. Temperature sensing is intended to be carried out in logging mode.

The do measurement command returns the 10-bit ADC result, formatted in a two-byte word as shown below,

ADC Result Format

Bit	15	14	13	12	11	10	9	8	7	6	5	4	3	2	1	0
ADC	0	0	0	0	0	0	ADC_RES[9:0]									

where:

ADC_RES[9:0] – ADC measurement result.

An example of a “good” reply is 0x0001AC (where 00 => no error in RFLAGS, and 01AC => ADC data). An ADC error reply is 01A3 (where 01 => error indicated in RFLAGS, A3 => ADC error code)

Get Log Status Command

Get Log Status Command Request:

SOF	Flags	Command	IC Mfg.	UID	CRC	EOF
	NFLAGS	0xAA	0x36	64 bits	16 bits	

Get Log Status Command Reply:

SOF	Flags	Log Stat	CRC	EOF
	RFLAGS	8 bits	16 bits	

The get log status command returns the current value of the status bits, in the format shown below,

Status Bits Format

Bit	7	6	5	4	3	2	1	0
Log Stat	ACTIVE	EEFULL	OVWRT	ADCERR	LOWBAT	ACTPOR	0	OVLIM

where:

OVLIM – Limit count threshold exceeded.

0 = No limit count thresholds exceeded.

1 = One of the eight limit count thresholds have been exceeded.

ACTPOR – Active wakeup after power-up reset.

0 = The AS39513 has not had a reset direct to ACTIVE mode event.

1 = The AS39513 has had a power on reset occur when WAKEMD = 1 and ACTIVE = 1.

LOWBAT – Low battery condition.

0 = No low battery condition measured.

1 = The battery check operation (BATCHK = 1) resulted in a low battery indication.

ADCERR – ADC error flag.

0 = No ADC error has occurred.

1 = An ADC error has occurred, either from an input signal out of range or a poorly chosen combination of reference voltage settings.

OVWRT – Measurement overwrite flag.

0 = No measurements have been overwritten.

1 = At least one measurement has been overwritten.

EEFULL – The EEPROM is full.

0 = More measurements can be logged.

1 = At least one measurement was not logged due to a lack of EEPROM space.

ACTIVE – Controller state.

0 = Controller is in the IDLE or WAIT modes.

1 = Controller is in the ACTIVE mode.

Security Levels

The security level has mainly to do with what area of memory is being accessed rather than which command is accessing it. See section [Memory Access Levels](#). A couple of columns from the table can be eliminated with the following statements:

- All RFID commands can be used in the IDLE, WAIT, and ACTIVE states, but not during LOGGING or initialization.
- The only command that changes the log controller state is “Set Mode”.
- The ISO15693 state (Ready, Quiet, Selected) is independent of the log controller state (IDLE, WAIT, etc.)

Figure 49:
Summary of Security Levels

Command	Command Code	Security Level	Definition
Inventory	0x01	None	Tag identification, anticollision.
Stay Quiet	0x02	None	Stop responding; reader is communicating with other tags.
Read Block	0x20	None	Read the requested block from application or measurement memory.
Write Block	0x21	A, M	Write to the requested block in application or measurement memory.
Lock Block	0x22	None	Mark a block in application or measurement memory as read only.
Read Multiple Blocks	0x23	None	Read multiple blocks from the application or measurement memory.
Select	0x25	None	Tag singulation.
Reset to Ready	0x26	None	Move tag out of quiet state.
Write AFI	0x27	S	Write AFI field.
Lock AFI	0x28	None	Prevent further writes to AFI field.
Write DSFID	0x29	S	Write DSFID field.

Command	Command Code	Security Level	Definition
Lock DSFID	0x2A	None	Prevent further writes to DSFID field.
Get System Info	0x2B	None	Return RFID system parameters.
Set Access	0xA0	None	Enable application, measurement, or system access with correct password.
Set Password	0xA1	A, M, S	Write a new password.
Read System Block	0xA2	None	Read the requested block from system memory.
Write System Block	0xA3	S	Write to the requested block in system memory.
Read Multiple System Blocks	0xA4	None	Read multiple blocks from the system memory.
Lock All Blocks	0xA6	None	Mark all measurement blocks as read only.
Do Measurement	0xA9	None	Do an ADC measurement of one of the sensors.
Set Mode	0xA8	None	Change the controller state.
Get Log Status	0xAA	None	Read the log controller status flags.

The access security levels are:

A = Application access required to access application area of EEPROM.

M = Measurement access required to access measurement area of EEPROM.

S = System access required to access system area of EEPROM.

Figure 50:
Security Levels

Security Level	Password	Access
None	No	All open
S	System Password	System area
A	Application Password	Application area
M	Measurement Password	Measurement area

SPI Commands

The AS39513 has a serial peripheral interface (SPI) bus that enable full and unlimited EEPROM access. Its primary purpose is production calibration and UID programming, but it could also be used by an application to configure the chip during device test.

The SPI bus uses four digital signals. Three of these signals are inputs: CE (SPI chip enable), SCLK (SPI clock), and DIN (SPI data input). One is an output: DOUT (SPI data output). The CE signal enables the SPI interface when high. (When CE is low, the DIN/DOUT pins are used by other application functions unless the SPI direct command “Set IO Mode” has locked the device in SPI mode). The CE input includes a 100k ohm pull down to ground. If driven externally the CE pin should have a 1nF capacitor connected to ground. The SCLK is used to control the timing of the output data and determine when to capture the input data. The maximum SCLK clock frequency is 100kHz. The SCLK input includes a 100k ohm pull down to ground. DIN data is captured on the falling edge of SCLK. DOUT data will change on the rising edge of SCLK. The DIN input can be configured to have a 100k ohm pull down to ground or 30k ohm pull up resistor. See DIMD[1:0].

When CE is set high, a delay time is needed to allow the on-chip high-speed clock and the digital supply regulators to wake up. (If the device is locked in SPI mode through the “Set IO Mode” direct command, this delay is much shorter since the high-speed clock and regulators remain active.) The SPI interface also needs to check that DOUT is low. If DOUT is high, this is a busy signal that indicates that the interface is not ready to receive SPI commands.

Once there has been sufficient delay and DOUT is low, the command and any additional input data are clocked in, MSB first, using SCLK and DIN. For commands with a response, the DOUT pin will go high to indicate data is ready, and then SCLK pulses are used to clock out the data on DOUT. For write commands, DOUT pin acts as a memory busy indicator, going high while the write is in progress.

Commands are not intended to be chained, that is, CE is expected to go low after each command. If a command requires additional processing time after CE goes low, such as an EEPROM write, the processing continues and the regulators and high-speed clock are not shut down until the command is processed.

All SPI commands and data are grouped along 8-bit byte boundaries. There are three types of commands: write commands, read commands, and direct commands. The two MSBs in the 8 or 16-bit command word selects the command type. Each command type is described below.

Write Command

The write command is used to write to both EEPROM and on-chip registers that are memory mapped.

The Write Command Format is below:

Bit	15	14	13	12	11	10	9	8	7	6	5	4	3	2	1	0
Write	0	0	0	0	0	ADDR[10:0]										

where:

ADDR[10:0] – Address of the memory to write to. See the description of the memory map below for details on what is mapped to the various memory addresses.

The write command word will be followed by one or more bytes of data. The first byte will be written to address ADDR, the second at ADDR+1, and so on. Note that the EEPROM architecture can only write to one 16-byte page at a time. Care must be taken to limit the number of data bytes in the Write Command such that the page boundary is not passed. Specifically, the number of data bytes must be less than or equal to 16 – ADDR[3:0]. If the number of bytes written would go beyond the page boundary at address { ADDR[10:4], 4'b1111 }, then the address counter will effectively wrap around to the start of the page boundary at { ADDR[10:4], 4'b0000 } and overwrite bytes at the start of the page.

The actual write operation is initiated by setting CE low. The DOUT pin will go high when the write is beginning. If SPI mode has been enabled via the direct command “Set IO Mode”, the DOUT pin will go low when the write is complete. (If the SPI mode direct command has not set the device to stay in SPI mode, the DOUT pin will revert to its non-SPI mode value when the write is complete.)

As example, the signals for a one-byte write are shown below.

Figure 51:
One-Byte Write

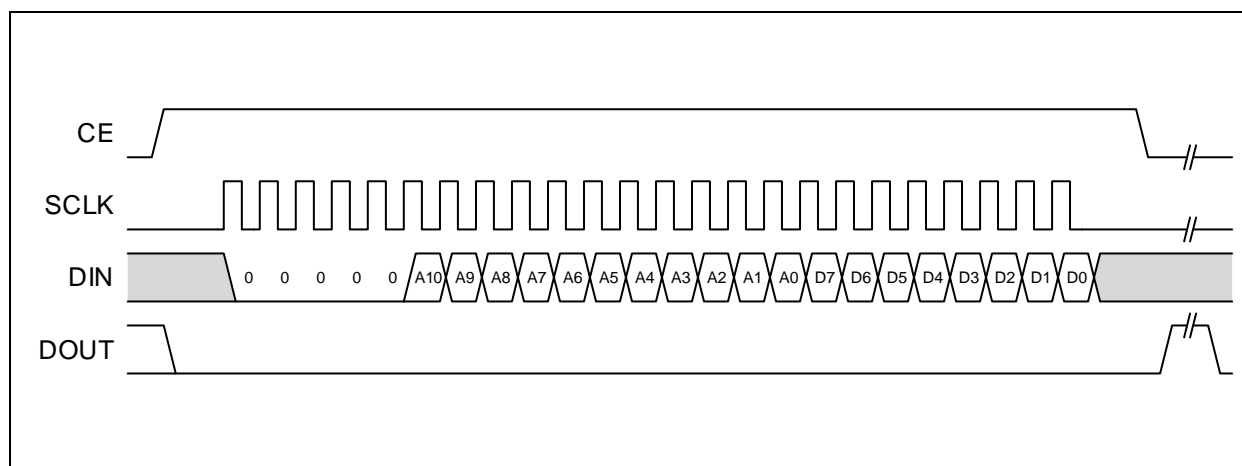

Read Command

The read command is used to read from both EEPROM and on-chip registers that are memory mapped.

The Read Command Format is below:

Bit	15	14	13	12	11	10	9	8	7	6	5	4	3	2	1	0
Read	0	1	0	0	0	ADDR[10:0]										

where:

ADDR[10:0] – Address of the memory to read from. See the description of the memory map below for details on what is mapped to the various memory addresses.

After the read command word is complete, DOUT will go high when the read operation is ready. SCLK should then be pulsed 8 times for each byte of data, and the data will be output on DOUT. The output data will be stable on the falling edge of SCLK. The first byte will be read from ADDR, the second byte from ADDR+1, and so on. There is no limit to the number of bytes that can be read. For example, the signals for a one-byte read are shown below. The read operation is completed when CE goes low.

As example, the signals for a one-byte read are shown below.

**Figure 52:
One-Byte Read**

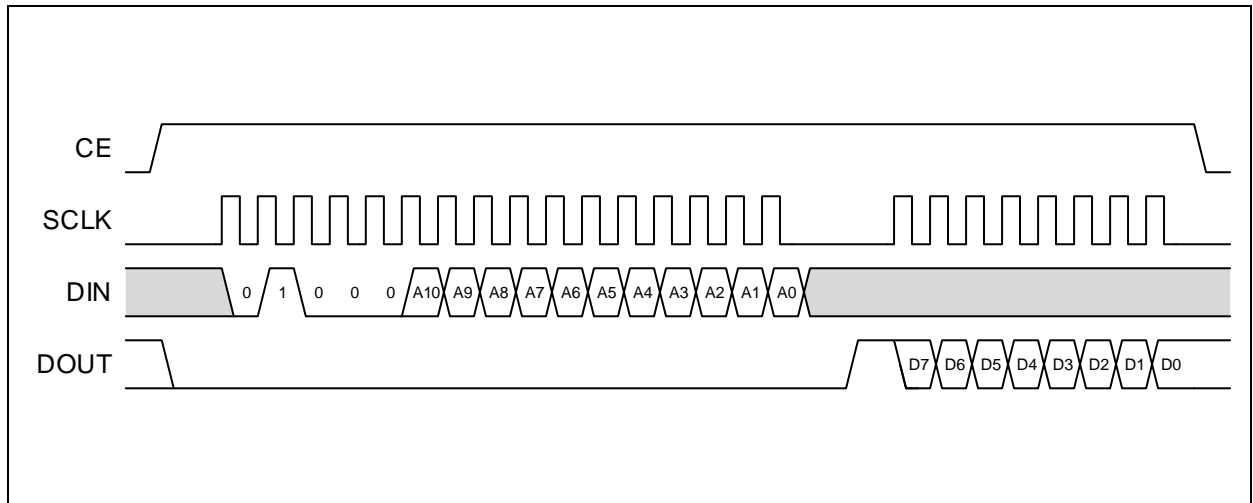

Direct Commands

The direct commands are used for operations that are not directly related or conveniently mapped to the memory.

The Direct Command Format is below:

Bit	7	6	5	4	3	2	1	0
Direct Command	1	1	DCOM[2:0]			DPARAM[2:0]		

where:

DCOM[2:0] – Direct command index. See the table below.

DPARAM[2:0] – Direct command parameter. Its use is command dependent as described in the table below.

The direct commands that are available are listed in the table below.

Figure 53:
Direct Commands

DCOM	Command	Description
3'b000	Reset	Create a master reset pulse that, like a POR, will reset all internal registers and cause the calibrations registers to be loaded from EEPROM. The DOUT signal will go high when the reset takes effect and will remain high while the calibration registers are loaded. This is implemented by generating a rising edge on the trig_rst input to the AFE.
3'b001	Set IO Mode	Force the digital I/O into a fixed state. The I/O will remain in that state until a reset or changed by another command. The I/O state is set by DPARAM, with the following values: 3'b000 = Application mode. 3'b001 = SPI mode. (Also forces 1.92 MHz clock to stay running.) 3'b010 = Scan mode (requires factory access).
3'b010	Read Hardware ID	Reads the one-byte hard-coded hardware identifier. DPARAM is ignored. The following identifiers are defined: 8'h11 = AS39513 version 2.0.
3'b100	Set Mode	Duplicates the functionality of the RFID Set Mode command. (See that command for more details.) The CMODE[1:0] parameter for the Set Mode command is taken from DPARAM[1:0].

DCOM	Command	Description
3'b110	Do Measurement	Duplicates the functionality of the RFID Do Measurement command. (See that command for more details.) Before sending this Direct command it is necessary to send a Reset Direct command via SPI. The DOMEAS[1:0] parameter for the Do Measurement command is taken from DPARAM[1:0]. The response is the same 16-bit format as the RFID Do Measurement command, unless there is an ADC error. In the case of an ADC error, 16'hA300 is returned. Note if TV2SET<TV1SET-1 which is not a valid configuration, a Do Measurement command via SPI will result in 0x0000 being read; the ADC error code 0xA300 is not returned in this particular case.
3'b111	Get Log Status	Duplicates the functionality of the RFID Get Log Status command. (See that command for more details.) The response is the same 8-bit format as the RFID Get Log Status command.

For direct commands that do not have a response, the signals are as illustrated below.

Figure 54:
Direct Commands Without Response

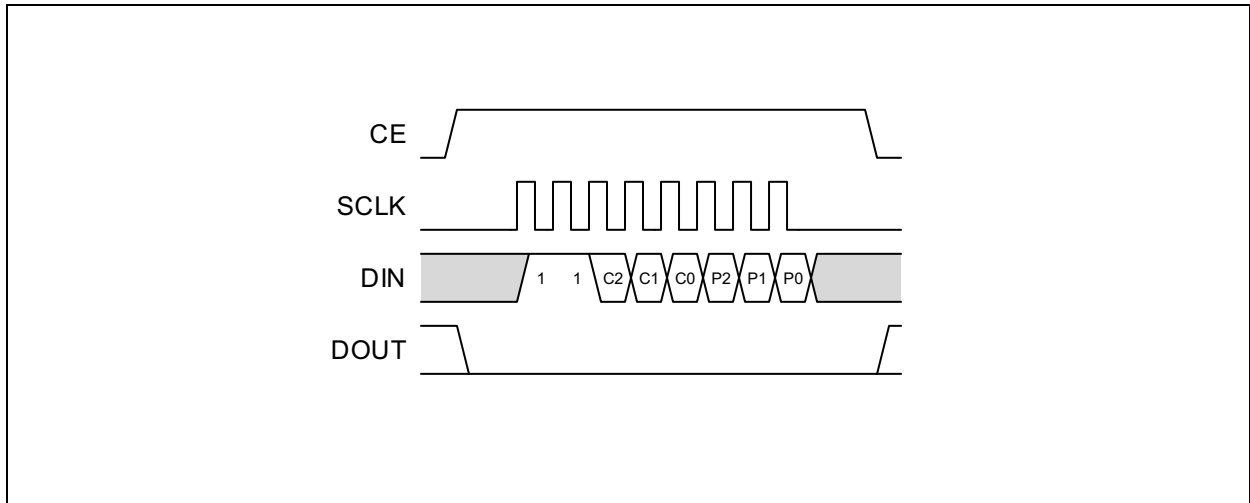

When a direct command has a response, the signaling is similar to the Read command, as shown below.

Figure 55:
Direct Commands with Response

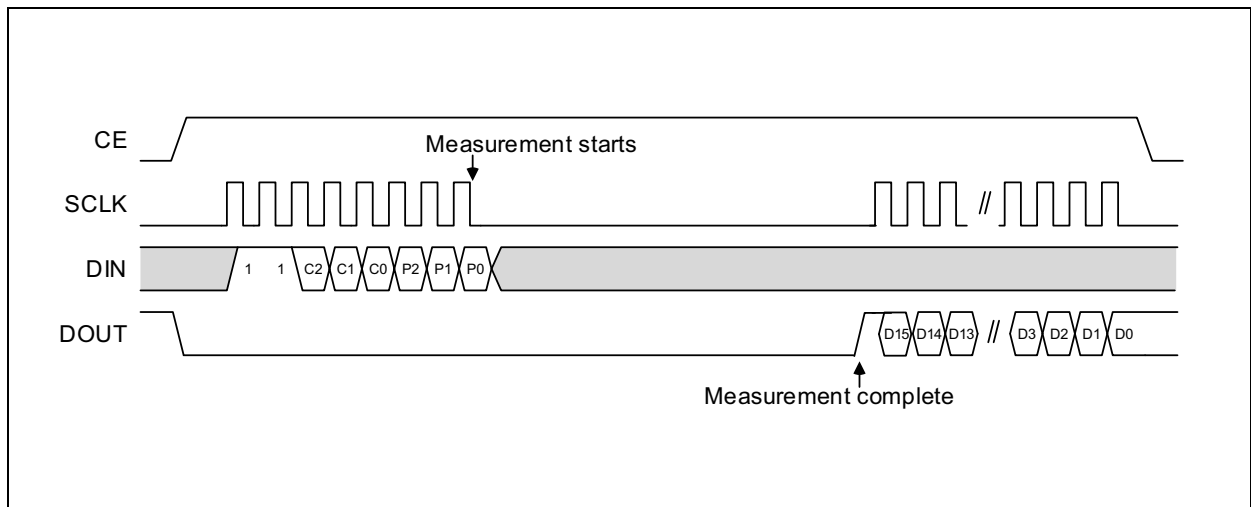

SPI Timing

This sections provides more details on the timing relationships and requirements for the SPI interface. The timing for the beginning of a command is independent of the command type, and is as shown below.

Figure 56:
SPI Timing Signals

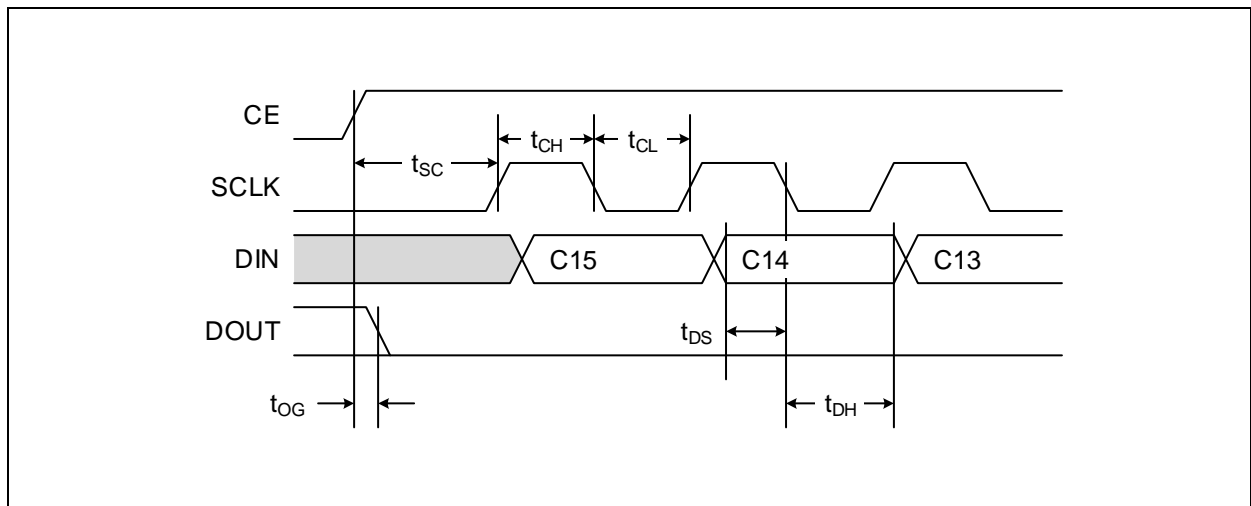

Where the timing parameters are as follows:

Figure 57:
Timing Parameters, VBAT = 3V or 1.5V (unless otherwise noted)

Symbol	Description	Min	Max	Unit
t_{SC}	CE to first SCLK rising edge setup time ⁽¹⁾	150		μs
t_{SC}	CE to first SCLK rising edge setup time, VBAT = 1.5V ⁽²⁾	2.0 ⁽³⁾		μs
t_{OG}	DOUT valid time		50	ns
t_{CH}	SCLK high period	5		ms
t_{CL}	SCLK low period	5		ms
t_{DS}	DIN data setup time	50		ns
t_{DH}	DIN data hold time	50		ns

Note(s):

1. When the digital interface was not already in SPI mode.
2. When the digital interface has been locked into SPI mode.
3. t_{SC} reduces to 0.4 μs @ VBAT=3V

The write command initiates a write with the falling edge of CE. If the interface is locked in SPI mode, the write processing status is indicated by a pulse on DOUT. This timing detail is shown below.

Figure 58:
Write Command Timing Detail

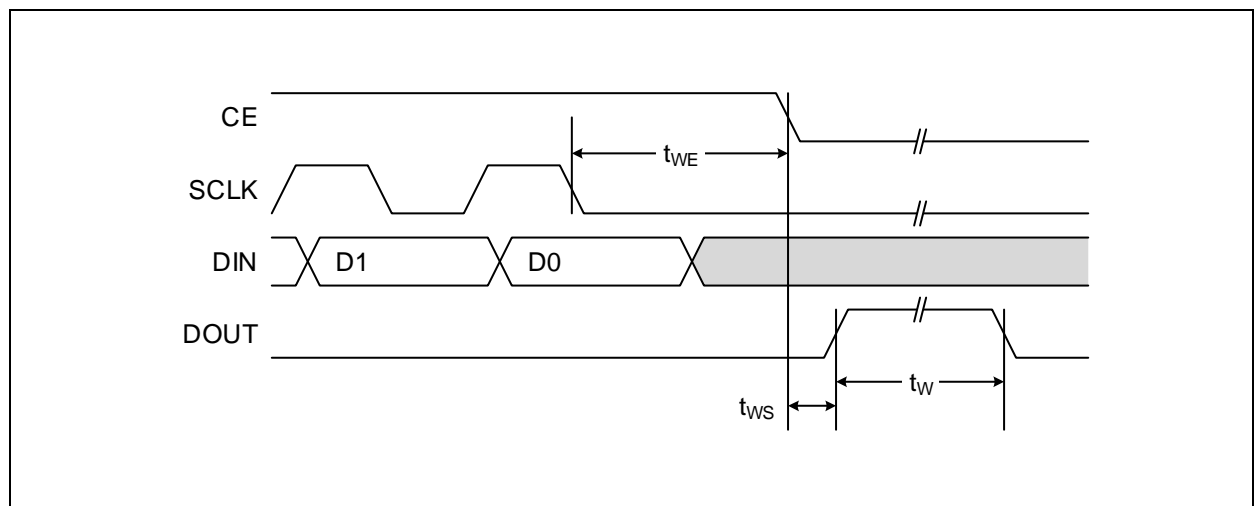

Where the timing parameters are as follows:

Figure 59:
Write Command Timing Parameters

Symbol	Description	VBAT = 1.5 V		VBAT = 3.0 V		Unit
		Min	Max	Min	Max	
t_{WE}	Falling edge of SCLK to write enable (falling edge of CE).	2.0		2.0		μ s
t_{WS}	Write enable to beginning of write processing.		200		200	ns
t_W	Processing time for writes.	6	14	6	14	ms

The read command has two more timing sections of interest. The first is the transition from the command at DIN to the read-back data at DOUT. That timing is shown below.

Figure 60:
Read Command Timing Detail

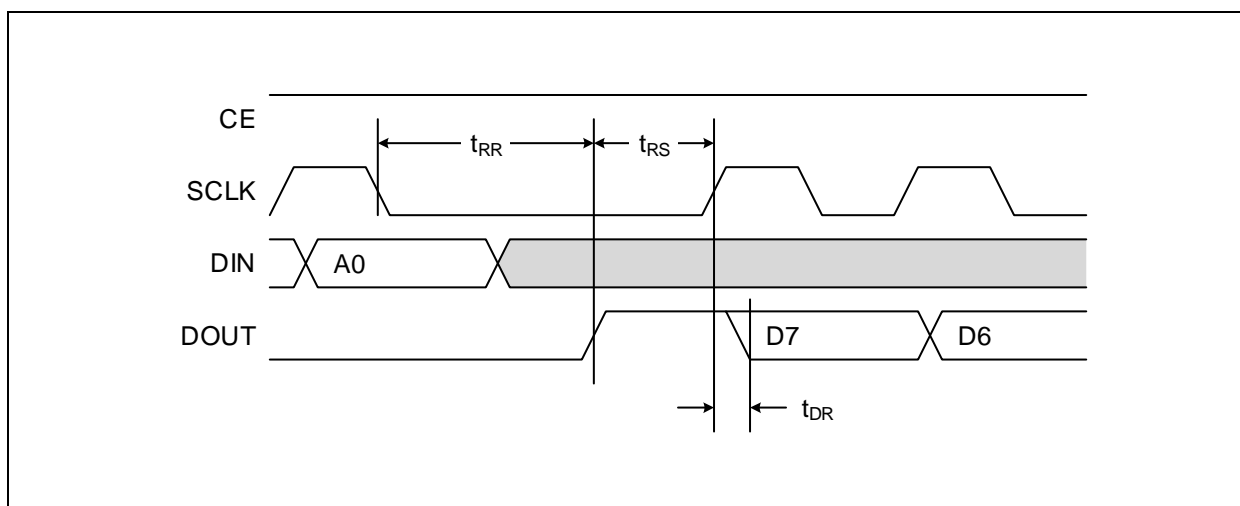

Where the timing parameters are:

Figure 61:
Read Command Timing Parameters

Symbol	Description	VBAT = 1.5 V		VBAT = 3.0 V		Unit
		Min	Max	Min	Max	
t_{RR}	Falling edge of SCLK to read ready time		4.0		4.0	μ s
$t_{RR} + t_{RS}$	Falling edge of SCLK to read ready on DOUT to SCLK rising edge	500		500		ns
t_{DR}	SCLK rising edge to valid data	50		50		ns

The last timing section of interest is the end of the data read-back at DOUT. That timing is shown below.

Figure 62:
Read-Back at DOUT Timing Detail

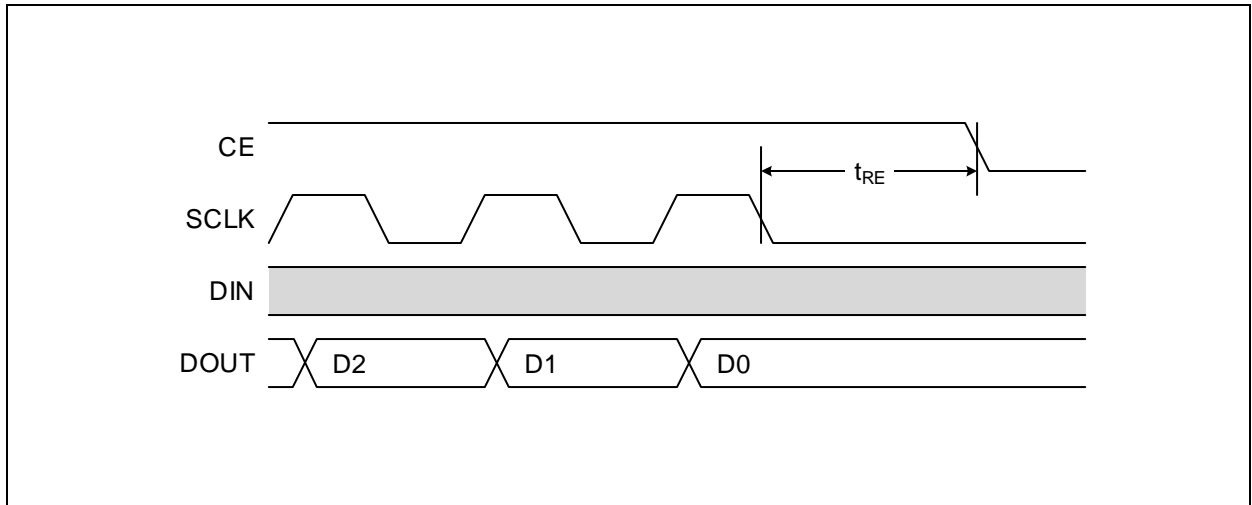

Where the timing parameter is:

Figure 63:
Read-Back at DOUT Timing Parameters

Symbol	Description	VBAT = 1.5 V		VBAT = 3.0 V		Unit
		Min	Max	Min	Max	
t_{RE}	Time from falling edge of SCLK to falling edge of CE.	2.0		2.0		μs

For the Direct SPI Command - Do Measurement Temperature the DOUT going high signals the measurement is complete and the measured data can be clocked out.

Figure 64:
Direct Command Timing Detail

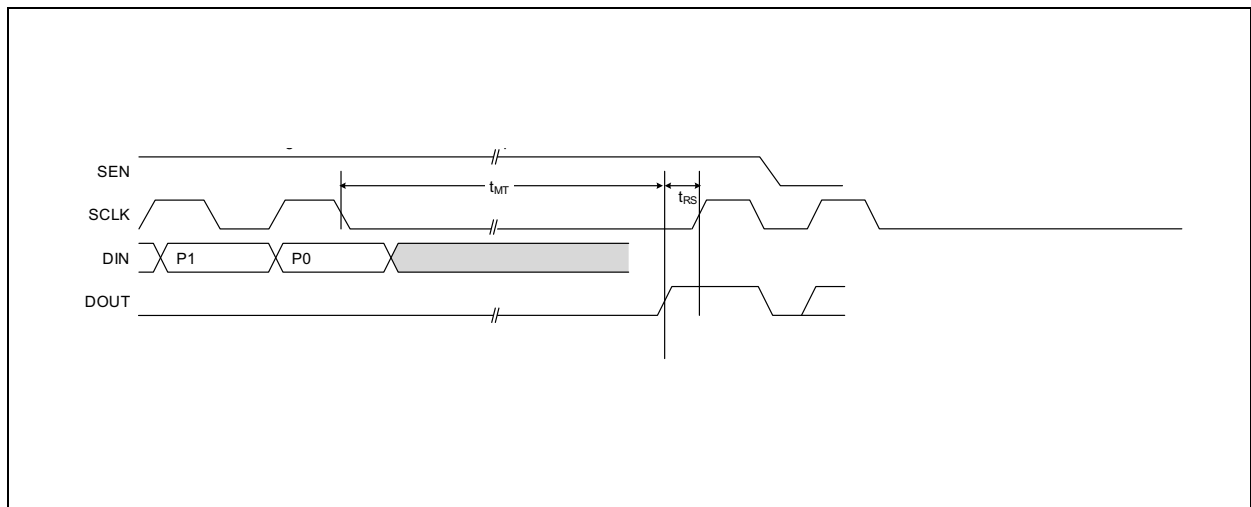
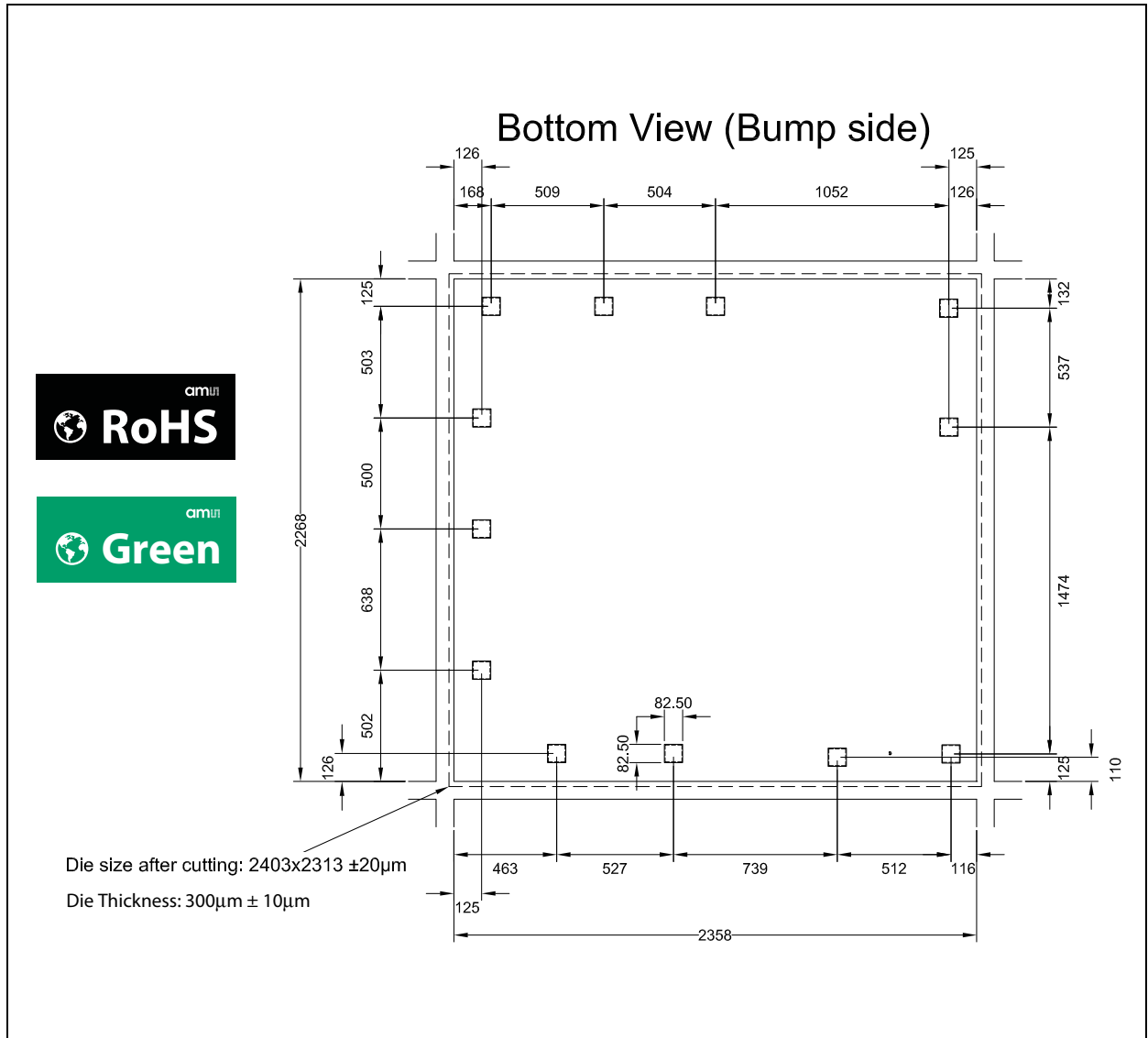

Figure 65:
Direct Command Timing Parameters – Do Measurement Temperature

Symbol	Description	VBAT = 1.5V		VBAT= 3.0V		Unit
		Min	Max	Min	Max	
t_{RS}	DOUT rising edge to SCLK rising edge	0		0		ns
t_{MT}	Measurement time SCLK falling edge to DOUT rising edge		6		6	ms

Package Drawings & Markings

Figure 66:
Package Outline Drawings Gold-Bumped Die (SW)



Note(s):

1. All dimensions are in µm.

Figure 67:
Package Outline Drawings Thin WL-CSP

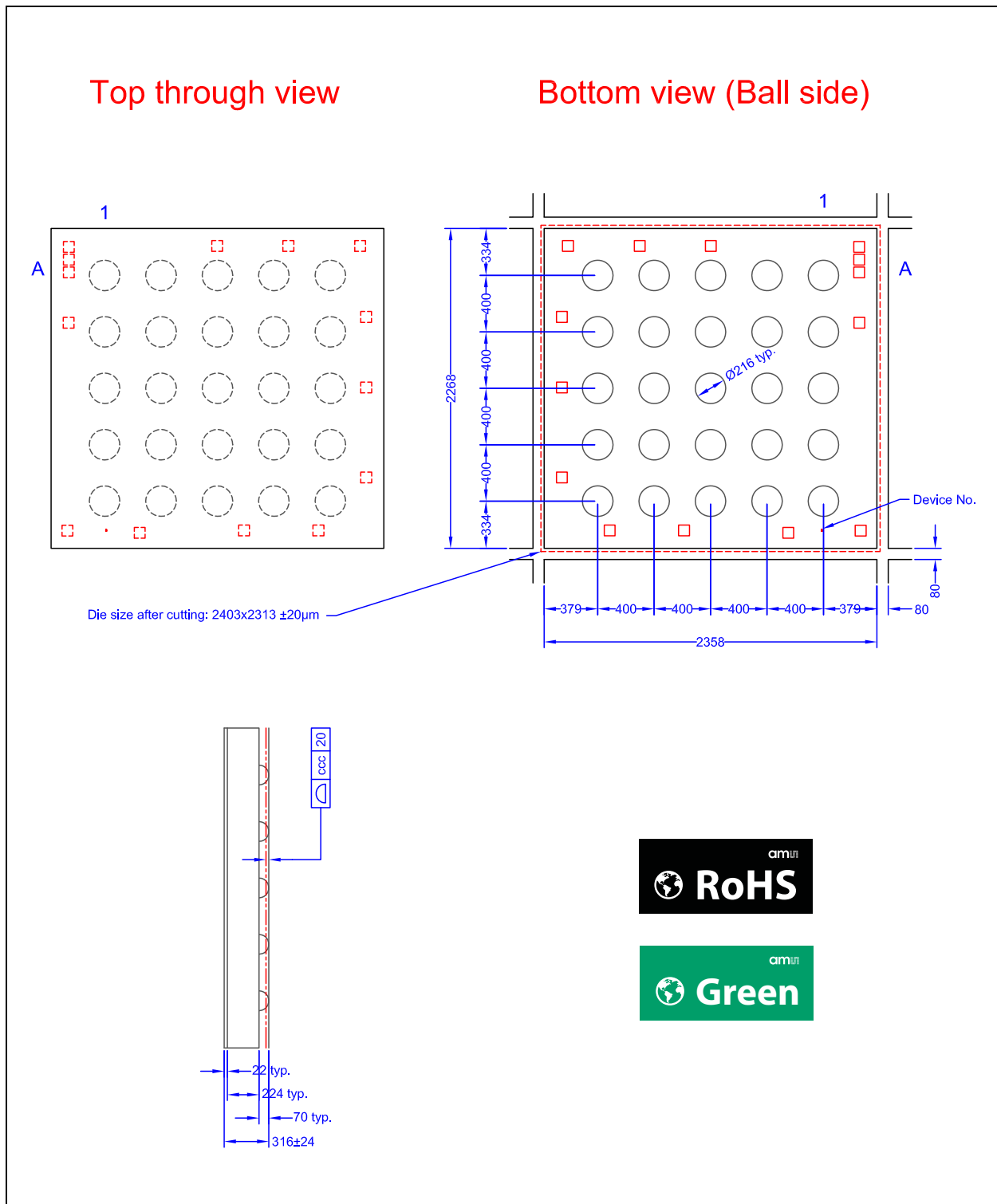

Note(s):

1. Pin 1 = A1
2. ccc Coplanarity
3. All dimensions are in µm.

Figure 68:
Package Marking Thin WL-CSP (3V trimmed part)

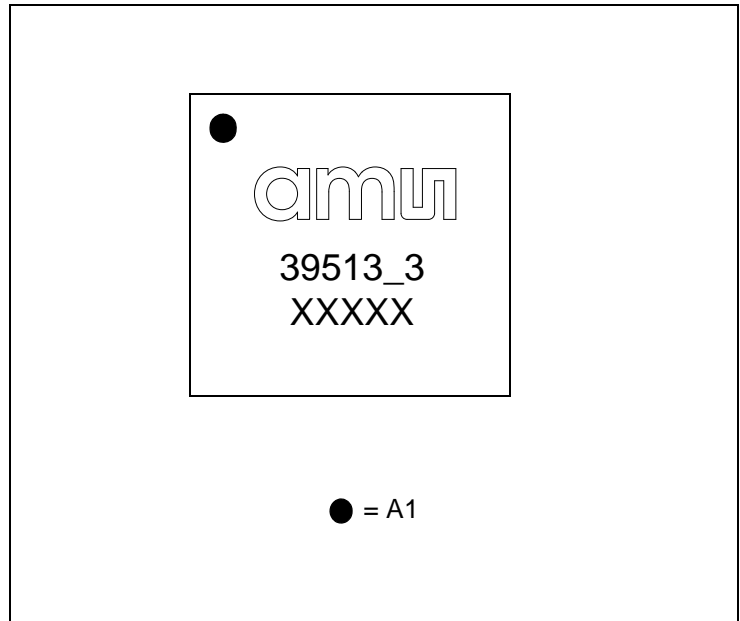

Note(s):
 1. XXXXX = Tracecode

Figure 69:
Package Marking Thin WL-CSP (1.5V trimmed part)

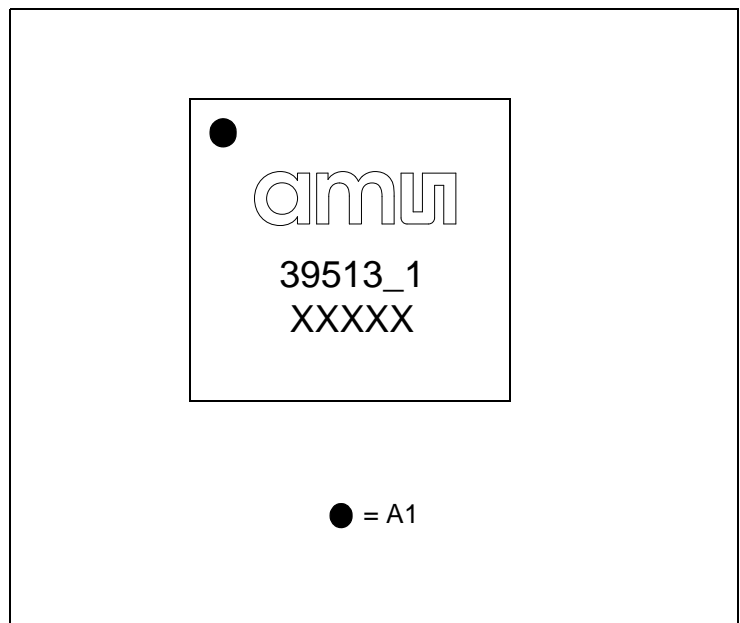

Note(s):
 1. XXXXX = Tracecode

Ordering & Contact Information

Figure 70:
Ordering Information

Ordering Code	Package	Marking	Delivery Form	Delivery Quantity
AS39513-ZSWF-30	Gold bumped wafer ⁽¹⁾ (3V trimmed)	NA	Sorted and sawn wafer on foil	1 wafer = ca. 4700 good die
AS39513-ZSWF-15	Gold bumped wafer ⁽¹⁾ (1.5V trimmed)	NA	Sorted and sawn wafer on foil	1 wafer = ca. 4700 good die
AS39513-ZTWT-30	Thin WL-CSP (3V trimmed)	39513_3	13" Tape & Reel	10000 pcs/reel
AS39513-ZTWT-15	Thin WL-CSP (1.5V trimmed)	39513_1	13" Tape & Reel	10000 pcs/reel
AS39513-ZTWM-30	Thin WL-CSP (3V trimmed)	39513_3	7" Tape & Reel	500 pcs/reel
AS39513-ZTWM-15	Thin WL-CSP (1.5V trimmed)	39513_1	7" Tape & Reel	500 pcs/reel

Ordering Information: Order quantities should be a multiple of shipping form.

Note(s):

- Limited quantities of gold bumped die are also available as engineering samples in wafer packs (1 wafer pack = 50 gold bumped die).

Buy our products or get free samples online at:

www.ams.com/ICdirect

Technical Support is available at:

www.ams.com/Technical-Support

Provide feedback about this document at:

www.ams.com/Document-Feedback

For further information and requests, e-mail us at:

ams_sales@ams.com

For sales offices, distributors and representatives, please visit:

www.ams.com/contact

Headquarters

ams AG
Tobelbader Strasse 30
8141 Premstaetten
Austria, Europe

Tel: +43 (0) 3136 500 0

Website: www.ams.com

RoHS Compliant & ams Green Statement

RoHS: The term RoHS compliant means that ams AG products fully comply with current RoHS directives. Our semiconductor products do not contain any chemicals for all 6 substance categories, including the requirement that lead not exceed 0.1% by weight in homogeneous materials. Where designed to be soldered at high temperatures, RoHS compliant products are suitable for use in specified lead-free processes.

ams Green (RoHS compliant and no Sb/Br): ams Green defines that in addition to RoHS compliance, our products are free of Bromine (Br) and Antimony (Sb) based flame retardants (Br or Sb do not exceed 0.1% by weight in homogeneous material).

Important Information: The information provided in this statement represents ams AG knowledge and belief as of the date that it is provided. ams AG bases its knowledge and belief on information provided by third parties, and makes no representation or warranty as to the accuracy of such information. Efforts are underway to better integrate information from third parties. ams AG has taken and continues to take reasonable steps to provide representative and accurate information but may not have conducted destructive testing or chemical analysis on incoming materials and chemicals. ams AG and ams AG suppliers consider certain information to be proprietary, and thus CAS numbers and other limited information may not be available for release.

Copyrights & Disclaimer

Copyright ams AG, Tobelbader Strasse 30, 8141 Premstaetten, Austria-Europe. Trademarks Registered. All rights reserved. The material herein may not be reproduced, adapted, merged, translated, stored, or used without the prior written consent of the copyright owner.

Devices sold by ams AG are covered by the warranty and patent indemnification provisions appearing in its General Terms of Trade. ams AG makes no warranty, express, statutory, implied, or by description regarding the information set forth herein. ams AG reserves the right to change specifications and prices at any time and without notice. Therefore, prior to designing this product into a system, it is necessary to check with ams AG for current information. This product is intended for use in commercial applications. Applications requiring extended temperature range, unusual environmental requirements, or high reliability applications, such as military, medical life-support or life-sustaining equipment are specifically not recommended without additional processing by ams AG for each application. This product is provided by ams AG "AS IS" and any express or implied warranties, including, but not limited to the implied warranties of merchantability and fitness for a particular purpose are disclaimed.

ams AG shall not be liable to recipient or any third party for any damages, including but not limited to personal injury, property damage, loss of profits, loss of use, interruption of business or indirect, special, incidental or consequential damages, of any kind, in connection with or arising out of the furnishing, performance or use of the technical data herein. No obligation or liability to recipient or any third party shall arise or flow out of ams AG rendering of technical or other services.

Document Status

Document Status	Product Status	Definition
Product Preview	Pre-Development	Information in this datasheet is based on product ideas in the planning phase of development. All specifications are design goals without any warranty and are subject to change without notice
Preliminary Datasheet	Pre-Production	Information in this datasheet is based on products in the design, validation or qualification phase of development. The performance and parameters shown in this document are preliminary without any warranty and are subject to change without notice
Datasheet	Production	Information in this datasheet is based on products in ramp-up to full production or full production which conform to specifications in accordance with the terms of ams AG standard warranty as given in the General Terms of Trade
Datasheet (discontinued)	Discontinued	Information in this datasheet is based on products which conform to specifications in accordance with the terms of ams AG standard warranty as given in the General Terms of Trade, but these products have been superseded and should not be used for new designs

Revision Information

Changes from 0-09 (2017-Oct-10) to current revision 1-00 (2017-Dec-06)	Page
0-09 (2017-Oct-10) to 0-10 (2017-Dec-06)	
Updated Figure 1	1
Updated Figure 7 and notes under it	9
Updated Figure 8	11
Updated text under Slave Serial Interface (SPI-like)	13
Updated text under Temperature Sensor	14
Updated Battery Check section	20
Updated text under ADC Output and Range for Temperature Measurement	38
Updated notes under Figure 27	39
Updated Figure 29	41
Updated Figure 37	54
Updated text under BATCHK	57
Updated text under BCKSEL[1:0]	58
Updated text under SPI Commands	92
Updated Figure 57	98
Updated Figure 66	102
0-10 (2017-Dec-06) to current revision 1-00 (2017-Dec-06)	
Initial production version for release	

Note(s):

1. Page and figure numbers for the previous version may differ from page and figure numbers in the current revision.
2. Correction of typographical errors is not explicitly mentioned.

Content Guide

1	General Description
1	Key Benefits & Features
2	Applications
3	Block Diagram
4	Pin and Pad Layout
5	Pin Description
7	Absolute Maximum Ratings
9	Electrical Characteristics
12	Detailed Description
12	Power Management
12	Energy Harvesting
12	Analog Front End (AFE)
13	Processing and Digital Control
13	Slave Serial Interface (SPI-like)
13	Real-Time Clock (RTC)
14	Temperature Sensor
14	External Sensor
14	Analog to Digital Converter
15	Data Protection
16	System Description & Modes of Operation
17	Initializing the Chip
17	RESET Mode
18	IDLE Mode
18	WAIT Mode
19	ACTIVE Mode
19	COMMAND Mode
19	LOGGING Mode
26	Data Log Functions
26	Storage Mode
27	Logging Timer
27	Delay Time
28	Manual Log Start
28	Logging Mode Data Formats
34	Analog to Digital Conversion
35	Reference Voltage Generator
36	ADC Scaling
38	ADC Output and Range for Temperature Measurement
40	ADC Output and Range for Battery Measurement
40	ADC Output and Range for External Sensor Measurement
41	GPIO
43	Memory Map
45	Memory Access Levels
48	System EEPROM
48	Global System Parameters
50	Temperature Sensor Parameters
52	External Sensor Parameters
53	Logging Control Parameters
62	Factory EEPROM
62	Factory Trim and RFID Parameters
64	Passwords

65	Memory Lock Bits
66	System Registers
66	Mirrored System Registers
67	Factory Registers
67	Mirrored Factory Registers
68	RFID Commands
69	Request Command Structure
70	Inventory Command Flags
71	Non-Inventory Command Flags
71	Command Response Structure
73	Inventory Command
74	Stay Quiet Command
74	Read Block Command
75	Write Block Command
75	Lock Block Command
76	Read Multiple Blocks Command
77	Select Command
77	Reset-to-Ready Command
78	Write AFI Command
78	Lock AFI Command
79	Write DSFID Command
79	Lock DSFID Command
80	Get System Info Command
81	Set Access Command
82	Set Password Command
83	Read System Block Command
84	Write System Block Command
85	Read Multiple System Blocks Command
86	Lock All Blocks Command
86	Set Mode Command
87	Do Measurement Command
89	Get Log Status Command
90	Security Levels
92	SPI Commands
93	Write Command
94	Read Command
95	Direct Commands
97	SPI Timing
102	Package Drawings & Markings
105	Ordering & Contact Information
106	RoHS Compliant & ams Green Statement
107	Copyrights & Disclaimer
108	Document Status
109	Revision Information