

ANT-M5PUK-SMA

- MIMO: Multi Input Multi Output
- IP67 Rated & UV Protected
- 5 x RG174 coax to SMA (3metres)
- Impedance 50ohm
- Operating Temp -40°C to $+85^{\circ}\text{C}$
- RoHs Compliant

GPS&GLONASS

- 1575.42-1610MHz
- VSWR <2.0
- Polarization: RCHP
- Gain 28+/-2dB
- Noise <1.5dB
- Supply 3-5Vdc
- <15mA Consumption

LTE Antenna MIMO

- 698-960 / 1710-2690MHz
- VSWR <3.0
- Polarization: Linear
- Gain +3dBi

WiFi Antenna MIMO

- 2400-2483.5 / 4900-5825MHz
- VSWR <2.5
- Polarization: Linear
- Gain +2dBi



Applications

- GPS Applications
- 4G / LTE GSM Applications
- Wifi

Description

A Rugged antenna for demanding applications. This antenna provides operation at Multi Frequencies for MIMO Applications. Housed in a rugged low profile ABS, it is IP67 (apart from the cable entry hole) and UV protected.

Part No	Description
ANT-M5PUK-SMA	Multi Frequency PUK antenna with SMA Male Connector

ANT-M5PUK



Mechanical Drawing

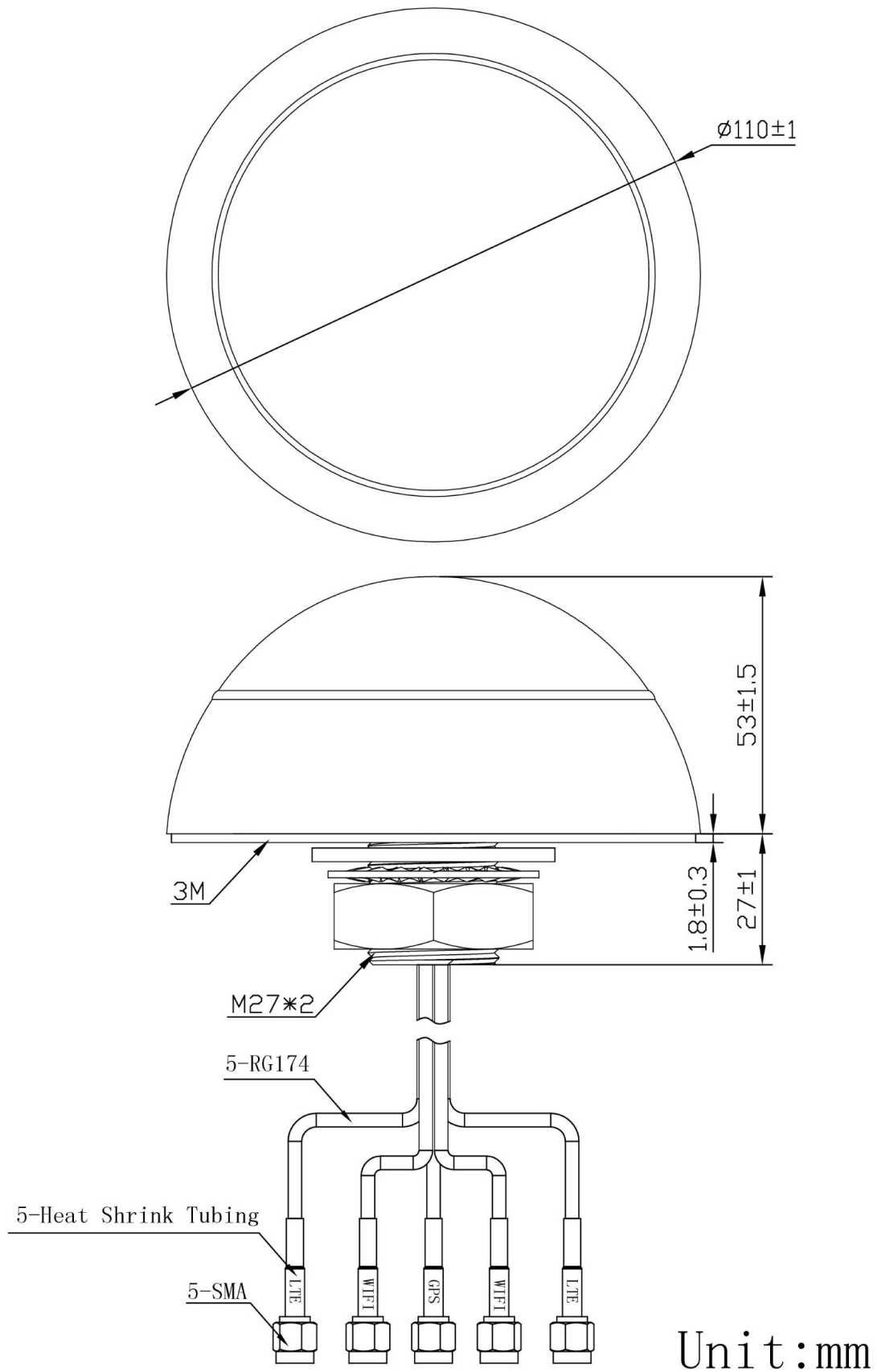

GPS Performance Data

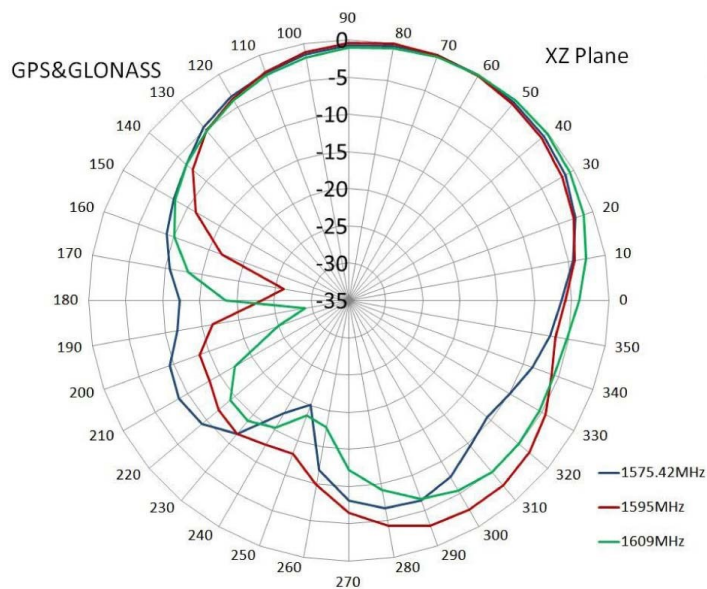
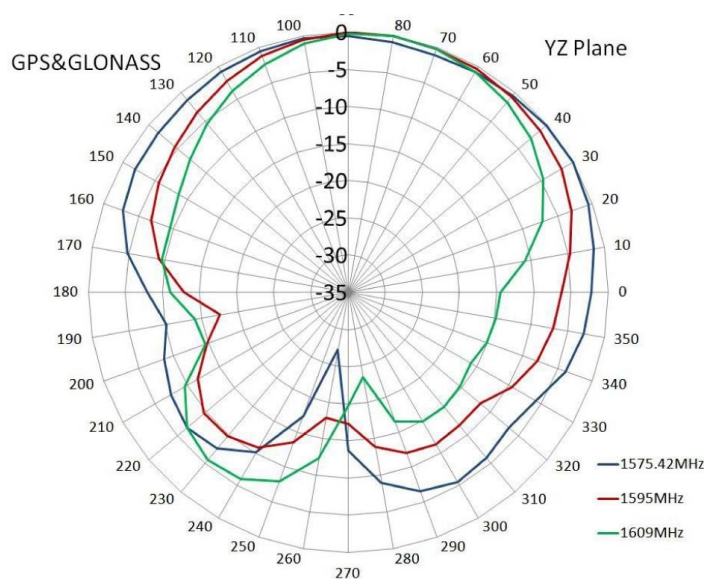
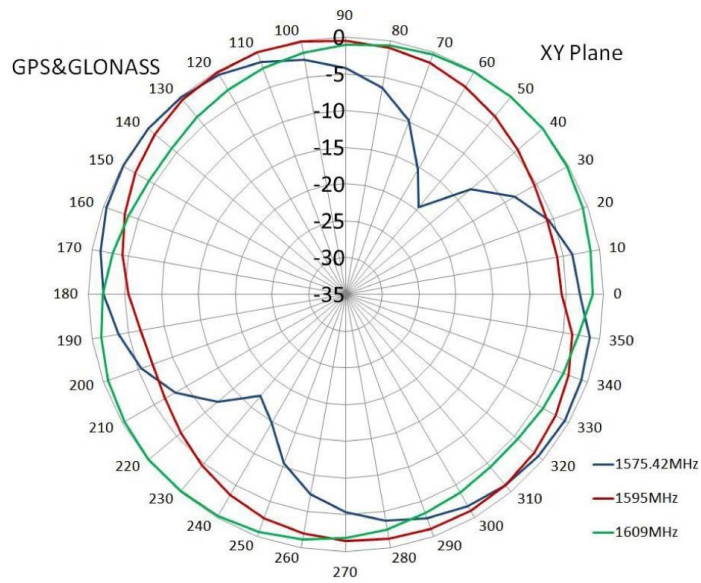

LTE Performance Data

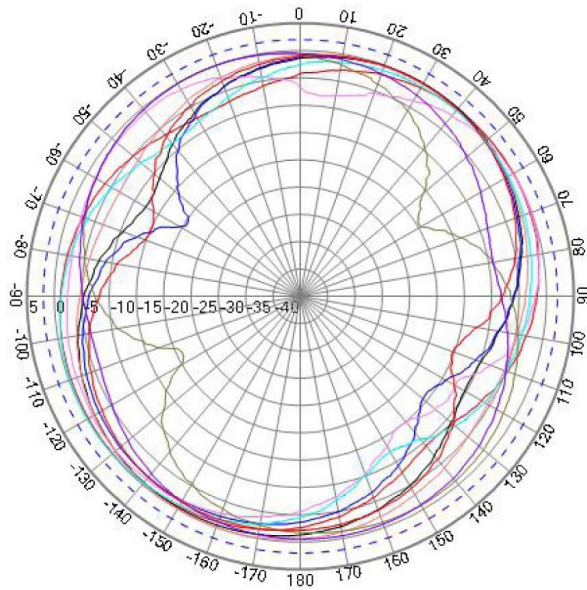

XY PLANE

- 测试频率: 700
- 测试频率: 824
- 测试频率: 868
- 测试频率: 960
- 测试频率: 1710
- 测试频率: 1850
- 测试频率: 1990
- 测试频率: 2170
- 测试频率: 2690

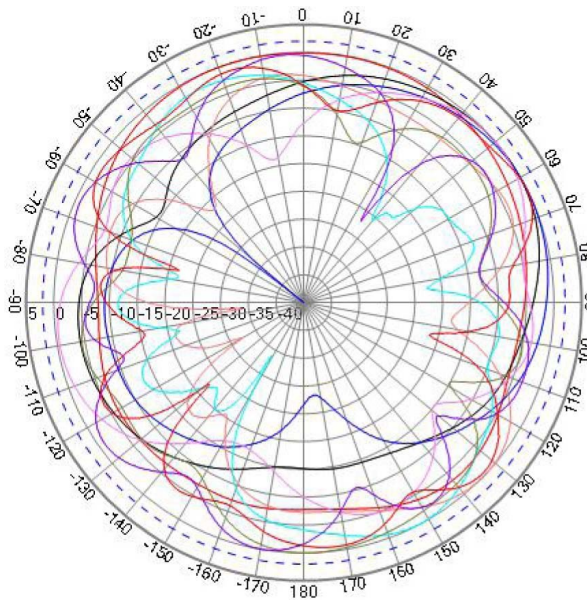

YZ PLANE

- 测试频率: 700
- 测试频率: 824
- 测试频率: 868
- 测试频率: 960
- 测试频率: 1710
- 测试频率: 1850
- 测试频率: 1990
- 测试频率: 2170
- 测试频率: 2690

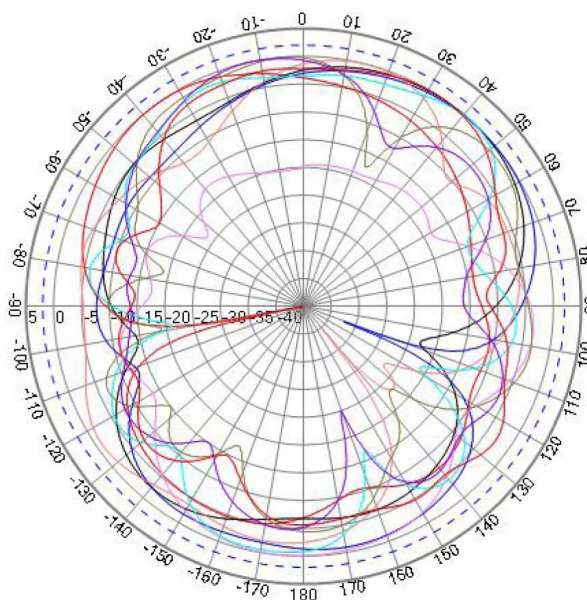

XZ PLANE

- 测试频率: 700
- 测试频率: 824
- 测试频率: 868
- 测试频率: 960
- 测试频率: 1710
- 测试频率: 1850
- 测试频率: 1990
- 测试频率: 2170
- 测试频率: 2690

WiFi Performance Data

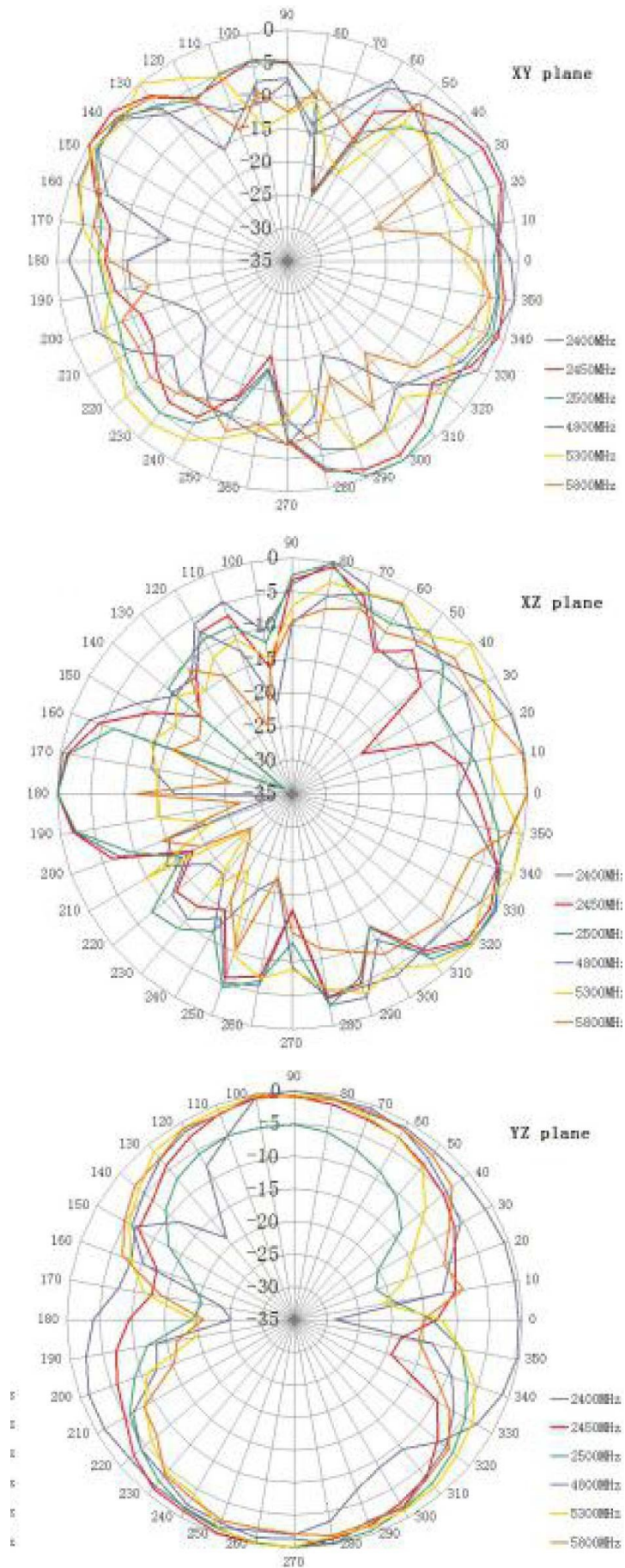

RF Solutions Ltd. Recycling Notice
Meets the following EC Directives:

DO NOT
Discard with normal waste, please recycle.

ROHS Directive 2002/95/EC
Specifies certain limits for hazardous substances.

WEEE Directive 2002/96/EC
Waste electrical & electronic equipment. This product
must be disposed of through a licensed WEEE collection point.
by membership of an approved compliance scheme.

Waste Batteries and Accumulators
Directive 2006/66/EC

Where batteries are fitted, before recycling the
product, the batteries must be
removed and disposed of at a licensed
collection point.

Environment Agency producer registration
number: WEE/JB0104WV.

RF Solutions Ltd., fulfills its WEEE obligations

Disclaimer:

Whilst the information in this document is believed to be correct at the time of issue, RF Solutions Ltd does not accept any liability whatsoever for its accuracy, adequacy or completeness. No express or implied warranty or representation is given relating to the information contained in this document. RF Solutions Ltd reserves the right to make changes and improvements to the product(s) described herein without notice. Buyers and other users should determine for themselves the suitability of any such information or products for their own particular requirements or specification(s). RF Solutions Ltd shall not be liable for any loss or damage caused as a result of user's own determination of how to deploy or use RF Solutions Ltd's products. Use of RF Solutions Ltd products or components in life support and/or safety applications is not authorised except with express written approval. No licences are created, implicitly or otherwise, under any of RF Solutions Ltd's intellectual property rights. Liability for loss or damage resulting or caused by reliance on the information contained herein or from the use of the product (including liability resulting from negligence or where RF Solutions Ltd was aware of the possibility of such loss or damage arising) is excluded. This will not operate to limit or restrict RF Solutions Ltd's liability for death or personal injury resulting from its negligence.